

YOUR ESSENTIAL GUIDE TO  
DIAGNOSIS AND MANAGEMENT

[www.myuptodate.com](http://www.myuptodate.com)

# OXFORD HANDBOOK OF ONCOLOGY

Jim Cassidy | Donald Bissett | Roy A. J. Spence  
Miranda Payne | Gareth Morris-Stiff

Extensively revised and updated, featuring recent advances in the field of oncology

Includes brand new chapters on the principles of immune therapy, and an explanation of the production of clinical practice guidelines

Concise and clear, with extensive references and further reading to direct readers to more in-depth analysis



FOURTH EDITION • FOURTH EDITION  
4

## راهنمای نصب آخرین نسخه آپتودیت آفلاین

۱. برای نصب اپلیکیشن در گوشی آیفون، برنامه App Store و در گوشی اندروید Play Store را اجرا کرده سپس عبارت Mehrsys medical library را جستجو کنید و برنامه را نصب کنید.

۲. بعد از نصب و اجرای اپلیکیشن در صفحه اول برنامه برای دریافت Username و Password به تلگرام پشتیبانی و فروش که در زیر تصویر اشاره شده است پیغام دهید.

### @MehrsysSupport

۳. در مرحله بعد حساب کاربری خود را بسازید.

۴. بعد از ورود به برنامه در قسمت یا منوی Download روی آیکون سه نقطه آبی رنگ که رو به روی UpToDate قرار دارد کلیک کنید و گزینه دانلود Download را انتخاب کنید با این عمل می توانید دانلود را به آسانی از طریق اینترنت انجام دهید.

## قابلیتهای برنامه

- دسترسی به آخرین نسخه آپتودیت آفلاین با قابلیت بروز رسانی
- امکان جستجو بسیار سریع مطالب بدون نیاز به اینترنت
- امکان مشاهده abstract رفرنسهای داخل مقالات آپتودیت
- قابل نصب بر روی گوشی و کامپیوتر
- دسترسی به دیگر منابع پزشکی و دارویی به صورت رایگان
- امکان انتخاب متون، کپی و ارسال آن به برنامه های دیگر
- هایلایت کردن متون در برنامه به رنگهای مختلف
- ذخیره کردن مقالات و عکسهای آپتودیت
- تولید شده توسط شرکت معتبر نرم افزاری و مورد تایید نظام صنفی رایانه ای کشور و شورای عالی انفورماتیک



OXFORD MEDICAL PUBLICATIONS

**Oxford Handbook of  
Oncology**

## Published and forthcoming Oxford Handbooks

- Oxford Handbook for the Foundation Programme 4e  
Oxford Handbook of Acute Medicine 3e  
Oxford Handbook of Anaesthesia 3e  
Oxford Handbook of Applied Dental Sciences  
Oxford Handbook of Cardiology 2e  
Oxford Handbook of Clinical and Laboratory Investigation 3e  
Oxford Handbook of Clinical Dentistry 6e  
Oxford Handbook of Clinical Diagnosis 3e  
Oxford Handbook of Clinical Examination and Practical Skills 2e  
Oxford Handbook of Clinical Haematology 3e  
Oxford Handbook of Clinical Immunology and Allergy 3e  
Oxford Handbook of Clinical Medicine—Mini Edition 8e  
Oxford Handbook of Clinical Medicine 9e  
Oxford Handbook of Clinical Pathology  
Oxford Handbook of Clinical Pharmacy 2e  
Oxford Handbook of Clinical Rehabilitation 2e  
Oxford Handbook of Clinical Specialties 9e  
Oxford Handbook of Clinical Surgery 4e  
Oxford Handbook of Complementary Medicine  
Oxford Handbook of Critical Care 3e  
Oxford Handbook of Dental Patient Care  
Oxford Handbook of Dialysis 3e  
Oxford Handbook of Emergency Medicine 4e  
Oxford Handbook of Endocrinology and Diabetes 3e  
Oxford Handbook of ENT and Head and Neck Surgery 2e  
Oxford Handbook of Epidemiology for Clinicians  
Oxford Handbook of Expedition and Wilderness Medicine 2e  
Oxford Handbook of Forensic Medicine  
Oxford Handbook of Gastroenterology & Hepatology 2e  
Oxford Handbook of General Practice 4e  
Oxford Handbook of Genetics  
Oxford Handbook of Genitourinary Medicine, HIV and AIDS 2e  
Oxford Handbook of Geriatric Medicine 2e  
Oxford Handbook of Infectious Diseases and Microbiology  
Oxford Handbook of Key Clinical Evidence  
Oxford Handbook of Medical Dermatology  
Oxford Handbook of Medical Imaging  
Oxford Handbook of Medical Sciences 2e  
Oxford Handbook of Medical Statistics  
Oxford Handbook of Neonatology  
Oxford Handbook of Nephrology and Hypertension 2e  
Oxford Handbook of Neurology 2e  
Oxford Handbook of Nutrition and Dietetics 2e  
Oxford Handbook of Obstetrics and Gynaecology 3e  
Oxford Handbook of Occupational Health 2e  
Oxford Handbook of Oncology 3e  
Oxford Handbook of Ophthalmology 3e  
Oxford Handbook of Oral and Maxillofacial Surgery  
Oxford Handbook of Orthopaedics and Trauma  
Oxford Handbook of Paediatrics 2e  
Oxford Handbook of Pain Management  
Oxford Handbook of Palliative Care 2e  
Oxford Handbook of Practical Drug Therapy 2e  
Oxford Handbook of Pre-Hospital Care  
Oxford Handbook of Psychiatry 3e  
Oxford Handbook of Public Health Practice 3e  
Oxford Handbook of Reproductive Medicine & Family Planning 2e  
Oxford Handbook of Respiratory Medicine 3e  
Oxford Handbook of Rheumatology 3e  
Oxford Handbook of Sport and Exercise Medicine 2e  
Oxford Handbook of Surgical Consent  
Oxford Handbook of Tropical Medicine 4e  
Oxford Handbook of Urology 3e



# Oxford Handbook of Oncology

Fourth edition

Edited by

## **Jim Cassidy**

Global Head of Translational Medicine (Oncology),  
Hoffmann La-Roche, USA

## **Donald Bissett**

Consultant in Clinical Oncology,  
Aberdeen Royal Infirmary, Aberdeen

## **Roy A. J. Spence OBE**

Consultant Surgeon, Belfast Trust,  
Honorary Professor, Queens University, Belfast,  
Honorary Professor, University of Ulster

## **Miranda Payne**

Specialist Registrar in Medical Oncology,  
Oxford Radcliffe NHS Trust, Oxford

## **Gareth Morris-Stiff**

Staff Surgeon, Cleveland Clinic, Cleveland, USA;  
Associate Professor, Lerner College of Medicine,  
Case Western Reserve University, Cleveland, USA

**OXFORD**  
UNIVERSITY PRESS

# OXFORD

UNIVERSITY PRESS

Great Clarendon Street, Oxford, OX2 6DP,  
United Kingdom

Oxford University Press is a department of the University of Oxford.  
It furthers the University's objective of excellence in research, scholarship,  
and education by publishing worldwide. Oxford is a registered trade mark of  
Oxford University Press in the UK and in certain other countries

© Oxford University Press 2015

The moral rights of the authors have been asserted

First edition published 2002,  
Second edition published 2006,  
Third edition published 2010,  
Fourth edition published 2015

Impression: 1

All rights reserved. No part of this publication may be reproduced, stored in  
a retrieval system, or transmitted, in any form or by any means, without the  
prior permission in writing of Oxford University Press, or as expressly permitted  
by law, by licence or under terms agreed with the appropriate reprographics  
rights organization. Enquiries concerning reproduction outside the scope of the  
above should be sent to the Rights Department, Oxford University Press, at the  
address above

You must not circulate this work in any other form  
and you must impose this same condition on any acquirer

Published in the United States of America by Oxford University Press  
198 Madison Avenue, New York, NY 10016, United States of America

British Library Cataloguing in Publication Data

Data available

Library of Congress Control Number: 2015934836

ISBN 978-0-19-968984-2

Printed in China by  
C&C Offset Printing Co. Ltd.

Oxford University Press makes no representation, express or implied, that the  
drug dosages in this book are correct. Readers must therefore always check  
the product information and clinical procedures with the most up-to-date  
published product information and data sheets provided by the manufacturers  
and the most recent codes of conduct and safety regulations. The authors and  
the publishers do not accept responsibility or legal liability for any errors in the  
text or for the misuse or misapplication of material in this work. Except where  
otherwise stated, drug dosages and recommendations are for the non-pregnant  
adult who is not breast-feeding

Links to third party websites are provided by Oxford in good faith and  
for information only. Oxford disclaims any responsibility for the materials  
contained in any third party website referenced in this work.

# Foreword

There have been major developments in the field of oncology in the past decade—most strikingly in the new information that has become available on the understanding of the biology of carcinogenesis. These changes have resulted from advances in technology which have led to rapid, less costly genomic studies and greater understanding of cell signalling pathways. These have come at a time of closer interaction between basic scientists and those involved with drug development and treatment. As a result, numerous new agents have been synthesized to interfere with pathways felt to be important in the development of malignant cells and their metastasis, and many of these have moved forward into various phases of clinical trials. Several new agents have entered clinical practice as a result and have broadened the therapeutic options in a variety of tumour types. In addition, radiotherapy techniques have improved dramatically to further increase therapeutic options. All these developments are occurring, as the incidence of most types of cancer is markedly increasing.

It is at just such a time of rapid change that a new edition of the Oxford Handbook of Oncology is of enormous value to all those involved in the management of cancer. All clinicians aim to manage their patients in the most effective and evidence-based manner, and this book will help them to achieve that by providing well-organized, up-to-date information on all important aspects of oncology. The excellent sections on aetiology, epidemiology, and genetics provide important information which can be passed on to patients when, as is often the case, they ask about why they have developed cancer. There are valuable sections which cover general management options, including the treatment of infections, the use of radiation therapy, and the roles of biological and targeted therapies. The subsequent sections, which cover key aspects of every major (and most of the less common) tumour types, are written in a concise and easily accessed format, providing all the key information that is needed to make important management decisions.

This book will continue to be of enormous value to a wide spectrum of those managing patients with cancer. It is already widely used by trainees and established oncologists alike but should, additionally, be of considerable interest and value to medical students, nurses, and a variety of para-medical personnel involved in oncology. It will also be a valuable asset for general practitioners, palliative care clinicians, and non-specialists who are increasingly becoming involved at some stage in the care pathway of cancer patients.

Professor Will Steward  
Head, Department of Cancer Studies  
and Molecular Medicine  
University of Leicester

# Preface

Welcome to the 4th edition of this handbook. Over the previous editions, we have tried to evolve the content and style to make the book more accessible and useful to our readers. This has continued in edition four with alterations, in response to reader feedback and as a result of new data emerging in many cancer fields. Oncology has continued to produce novel diagnostics, treatment strategies, and drugs which benefit patients. The so-called 'standard of care' is a moving target, and significant differences do exist across nations. As far as possible, we have tried to indicate these controversies and invite the reader to explore them through suggested reading lists. The book is not a comprehensive textbook but serve as a primer and base, on which to build more detailed understanding of the disease and its management.

This is our fourth attempt to perfect the handbook. It will never be perfect—thankfully, oncology practice moves so quickly we will always be chasing. However, we have individually and collectively made extensive updates to the content. We hope that it is adequately broad, and yet detailed enough, to serve its purpose.

This has become a labour of love for the editorial team. Many of us have moved on in our respective careers but continue to give our time and energy to this handbook. We hope you enjoy reading it as much as we enjoy editing.

Once more, we have to thank our respective 'significant others' for their tolerance of us spending more time bashing the laptops.

Jim Cassidy  
Donald Bissett  
Roy A. J. Spence  
Miranda Payne  
Gareth Morris-Stiff

# Disclosure

Jim Cassidy has served as Global Translational Medicine Head for Roche Oncology, and now serves as VP for Early Clinical and Translational Research at Bristol-Myers Squibb.

# Acknowledgements

This book would not have come into being without the support of our editorial team at Oxford University Press. In particular, we would like to thank our assistant commissioning editor Michael Hawkes, who has very successfully achieved the challenging task of keeping the co-editors and other contributors to their promised schedule, providing encouragement and expert advice through the development of this edition of the *Oxford Handbook of Oncology*.

Roy A. J. Spence would especially like to acknowledge the enormous help from his academic secretary Meg Alton, who helped with the references and who typed the surgical changes in this book. Meg sadly died of cancer as the book was completed.

We are indebted to the following contributors for their expert input to specific chapters:

## **Dr Dominic Culligan**

*Haematological malignancies*  
Consultant in Haemato-Oncology  
Aberdeen Royal Infirmary, Aberdeen

## **Dr Rosemary Davidson**

*The genetics of cancer*  
Consultant Clinical Geneticist  
Ferguson Smith Centre for Clinical  
Genetics, Glasgow

## **Mr Mohantha Dooleniya**

*Genitourinary cancers*  
*Urinary tract obstruction*  
Consultant Onco-Urology Surgeon  
Southend University Hospital,  
Southend

## **Professor Jeff Evans**

*Upper gastrointestinal cancer*  
Professor of Translational Cancer  
Research  
University of Glasgow, Glasgow

## **Dr Ann-Marie Kennedy**

*Tumours of the central nervous system*  
Consultant in Clinical Oncology  
Aberdeen Royal Infirmary, Aberdeen

## **Mr Aamir Z Khan**

*Upper gastrointestinal cancer*  
Consultant Surgeon  
Royal Marsden Hospital, London

## **Mr Stuart McIntosh**

*Breast cancer*  
Consultant Breast Surgeon  
Belfast City Hospital, Belfast

## **Dr Tim Morgan**

*Principles of symptom control in  
palliative care*  
Consultant in Palliative Care  
Roxburghe House, Aberdeen

## **Dr Nadeem Siddiqui**

*Gynaecological cancers*  
Consultant Gynaecological  
Oncologist  
Glasgow Royal Infirmary, Glasgow

We would also like to give special thanks to all those who have contributed either directly or indirectly to previous editions of the *Oxford Handbook of Oncology*.

# Contents

Symbols and abbreviations *xii*

## Part 1 Background

1	Aetiology and epidemiology	3
2	The genetics of cancer	17
3	Surgical oncology	31

## Part 2 Principles of treatment

4	Principles of radiation oncology	49
5	Principles of chemotherapy	83
6	Principles of symptom control in palliative care	111
7	Late effects of chemotherapy and radiotherapy	157
8	Hormone therapy	169
9	Targeted and biological therapies	179

## Part 3 Clinical trials, cancer prevention, and screening

10	Clinical trials	199
11	Cancer prevention	203
12	Population screening for cancer	217

## Part 4 Specific types of cancer

13	Thoracic malignancies	225
14	Breast cancer	261
15	Colorectal cancer	299

16	Anal cancer	311
17	Upper gastrointestinal cancer	317
18	Endocrine cancers	381
19	Genitourinary cancers	403
20	Gynaecological cancers	445
21	Head and neck cancers	467
22	Tumours of the central nervous system	495
23	Skin cancers	523
24	Haematological malignancies	549
25	Bone and soft tissue malignancies	603
26	Malignancy of unknown primary	629
27	Paraneoplastic syndromes	645
28	AIDS-related malignancies	655
29	Childhood cancers presenting in adults	671

## Part 5 Emergencies in oncology

30	Spinal cord compression and bone marrow suppression	681
31	Overview of acute oncology	691
32	Superior vena cava obstruction and raised intracranial pressure	695
33	Airway obstruction	703
34	Thromboembolic and cardiac emergencies	711
35	Obstruction	719
36	Biochemical crises	731
37	Complications of long-term central venous lines and chemotherapy extravasation	743



**Part 6 The way forward**

38	Novel therapeutic strategies	749
39	Gene therapy and genetic immunotherapy for cancer	759
40	Biomarkers and cancer	773

**Part 7 Appendices**

	Appendix 1 NCIC common toxicity criteria (CTC) grading system (March 1998, revised)	785
	Appendix 2 Nomogram for the determination of body surface area	853
	Appendix 3 Performance status	855
	Appendix 4 Support agencies' addresses and websites	857

	Index	859
--	-------	-----

# Symbols and abbreviations

~	approximately
°C	degree Celsius
°F	degree Fahrenheit
↓	decreased
↑	increased
≥	equal to or greater than
>	greater than
<	less than
→	leads to
%	per cent
±	plus or minus
α	alpha
β	beta
γ	gamma
λ	lambda
♂	male
♀	female
1°	primary
2°	secondary
AASLD	American Association for the Study of Liver Diseases
ABG	arterial blood gas
ABVD	Adriamycin <sup>®</sup> , bleomycin, vinblastine, dacarbazine
AC	Adriamycin <sup>®</sup> (doxorubicin), cyclophosphamide
ACh <sub>m</sub>	muscarinic acetylcholine (receptor)
ACTG	AIDS Clinical Trials Group
ACTH	adrenocorticotrophic hormone
ADA	adenosine deaminase
ADH	antidiuretic hormone
AF	atrial fibrillation
AFP	alpha-fetoprotein
AGC	absolute granulocyte count
AIDS	acquired immune deficiency syndrome
AIN	anal intraepithelial neoplasia
AJCC	American Joint Committee on Cancer
ALK	anaplastic lymphoma kinase
ALL	acute lymphoblastic leukaemia

AML	acute myeloid leukaemia
ANC	absolute neutrophil count
AND	axillary node dissection
AP	area postrema
APC	adenomatous polyposis coli
APL	acute promyelocytic leukaemia
ARDS	adult respiratory distress syndrome
ARF	acute renal failure
ART	antiretroviral therapy
ASCT	autologous stem cell transplantation
ATLL	adult T-cell leukaemia/lymphoma
ATO	arsenic trioxide
ATRA	all- <i>trans</i> retinoic acid
AUC	area under the curve
AV	arteriovenous; atrioventricular
BCC	basal cell carcinoma
BCG	bacillus Calmette–Guérin
BCLC	Barcelona Clinic Liver Cancer
B-CLL	B-cell chronic lymphocytic leukaemia
BCSH	British Committee for Standards in Haematology
bd	<i>bis in die</i> (twice daily)
BEACOPP	bleomycin, etoposide, doxorubicin, cyclophosphamide, vincristine, procarbazine, prednisolone
BEP	bleomycin, etoposide, cisplatin
BL	Burkitt's lymphoma
BMP	bone morphogenetic protein
BMT	bone marrow transplantation
BP	blood pressure
BSG	British Society of Gastroenterology
BSO	bilateral salpingo-oophorectomy
BTS	British Thoracic Society
Ca <sup>2+</sup>	calcium ion
Ca19.9	carbohydrate antigen 19.9
CAV	cyclophosphamide, doxorubicin, vincristine
CCNU	1-(20-chloroethyl)-3-cyclohexyl-1-nitrosurea
CEA	carcinoembryonic antigen
CHART	continuous hyperfractionated accelerated radiotherapy
CHF	congestive heart failure
CHM	complete hydatidiform mole
CHOP	cyclophosphamide, doxorubicin, vincristine, and prednisolone

CIN	cervical intraepithelial neoplasia
CIS	carcinoma <i>in situ</i>
CK	creatine kinase
CLA	common leucocyte antigen
CLL	chronic lymphocytic leukaemia
CMF	cyclophosphamide, methotrexate, fluorouracil
cmH <sub>2</sub> O	centimetre of water
CML	chronic myeloid leukaemia
CMML	chronic myelomonocytic leukaemia
CMV	cisplatin, methotrexate, vinblastine; cytomegalovirus
CNS	central nervous system; clinical nurse specialist
CO	cyclophosphamide and vincristine
CO <sub>2</sub>	carbon dioxide
COPD	chronic obstructive pulmonary disease
CPK	creatine phosphokinase
CPT	camptothecin
CR	complete remission
CRLM	colorectal liver metastases
CRP	C-reactive protein
CRT	conformal radiotherapy
CSF	cerebrospinal fluid
CSI	craniospinal irradiation
CT	computerized tomography
CTC	circulating tumour cell; common toxicity criteria
CTV	clinical target volume
CUP	carcinoma of unknown primary
CVA	cerebrovascular accident
CVP	cyclophosphamide, vincristine, and prednisolone; central venous pressure
CXR	chest X-ray
4D	four-dimensional
Da	dalton
DAT	direct antiglobulin
D & C	dilation and curettage
DC	dendritic cell
DCIS	ductal carcinoma <i>in situ</i>
DFS	disease-free survival
DHAP	cisplatin, ara-C, dexamethasone
DHFR	dihydrofolate reductase
DIC	disseminated intravascular coagulation

dL	decilitre
DLBL	diffuse large B-cell non-Hodgkin's lymphoma
DLT	dose-limiting toxicity
DNA	deoxyribonucleic acid
DTIC	dacarbazine
dTTP	2'-deoxythymidine 5'-triphosphate
dUMP	2'-deoxyuridine 5'-triphosphate
DVT	deep vein thrombosis
EASL	European Association for the Study of the Liver
EBMT	European Group for Blood and Marrow Transplantation
EBRT	external beam radiotherapy
EBUS	endobronchial ultrasound
EBV	Epstein–Barr virus
ECarb	etoposide plus carboplatin
ECF	epirubicin, cisplatin, fluorouracil
ECG	electrocardiogram
ECOG	Eastern Cooperative Oncology Group
ECX	epirubicin, cisplatin, capecitabine
EDTA	ethylenediaminetetra-acetic acid
EFS	event-free survival
EGF	epidermal growth factor
EGFR	epidermal growth factor receptor
EMA	etoposide, methotrexate, and actinomycin D; European Medicines Agency
EMG	electromyography
ENT	ear, nose, and throat
EORTC	European Organisation for Research and Treatment of Cancer
EP	etoposide plus cisplatin
EPA	eicosapentanoic acid
EPID	electronic portal imaging device
EPO	erythropoietin
ER	(o)estrogen receptor
ERCP	endoscopic retrograde cholangio-pancreatography
ESR	erythrocyte sedimentation rate
EUS	endoscopic ultrasound
FA	folinic acid
FAMM	familial atypical multiple mole and melanoma
FAP	familial adenomatous polyposis
FBC	full blood count

FC	fludarabine and cyclophosphamide
FCR	fludarabine, cyclophosphamide, and rituximab
FDG	fluorodeoxyglucose
FDG-PET	fluorodeoxyglucose positron emission tomography
FdUMP	5-fluoro-2-deoxyuridine 5-monophosphate
FFS	failure-free survival; freedom from salvage
FIGO	International Federation of Gynecology and Obstetrics
FISH	fluorescence <i>in situ</i> hybridization
FL	follicular lymphoma
FLR	functional liver remnant
FNA	fine-needle aspiration
FOB	faecal occult blood
FSH	follicle-stimulating hormone
FSRT	fractionated stereotactic radiotherapy
GABA	gamma-amino butyric acid
GBM	glioblastoma multiforme
G-CSF	granulocyte colony-stimulating factor
GELA	Groupe d'Étude des Lymphomes des Adultes
GFR	glomerular filtration rate
GGT	gamma-glutamyl transpeptidase
GH	growth hormone
GI	gastrointestinal
GIST	gastrointestinal stromal tumour
GnRH	gonadotrophin-releasing hormone
GOJ	gastro-oesophageal junction
GP	general practitioner
GPAT	genetic pro-drug activation therapy
GTD	gestational trophoblastic disease
GTP	guanosine triphosphate
GTV	gross tumour volume
GVHD	graft-versus-host disease
GVL	graft versus leukaemia
Gy	gray
h	hour
HAART	highly active antiretroviral therapy
Hb	haemoglobin
HBV	hepatitis B virus
HCC	hepatocellular carcinoma
HCG	human chorionic gonadotrophin
HCV	hepatitis C virus

HDC	high-dose chemotherapy
HDI	high-dose IV interferon alfa-2b
HDR	high-dose-rate
HGPRT	hypoxanthine guanine phosphoribosyl transferase
HHV	human herpesvirus
5-HIAA	5-hydroxyindoleacetic acid
HIV	human immunodeficiency virus
HL	Hodgkin's lymphoma
HLA	human leucocyte-associated antigen
HNPCC	hereditary non-polyposis colon cancer
HPB	hepato-pancreato-biliary
HPL	human placental lactogen
HPV	human papillomavirus
HRT	hormone replacement therapy
HSV	herpes simplex virus
5-HT <sub>3</sub>	5-hydroxytryptamine
HUS	haemolytic uraemic syndrome
<sup>131</sup> I	radioiodine
ICG	indocyanine green
ICP	intracranial pressure
ICSI	intracytoplasmic sperm injection
ICT	intracavitary brachytherapy
ICU	intensive care unit
IFN	interferon
IFR	involved field radiotherapy
Ig	immunoglobulin
IGCCC	International Germ Cell Consensus Classification
IGF	insulin-like growth factor
IGRT	image-guided radiotherapy
IHC	immunohistochemistry
IL	interleukin
IMRT	intensity-modulated radiotherapy
INR	international normalized ratio
IORT	intraoperative radiotherapy
IOUS	intraoperative ultrasound
IPI	International Prognostic Index
IPMN	intraductal papillary mucinous neoplasm
IPSS	International Prognostic Scoring System
ITD	internal tandem duplication
IU	international unit

IVC	inferior vena cava
IVU	intravenous urography
K <sup>+</sup>	potassium
kDa	kilodalton
keV	kilo-electron volt
kPa	kilopascal
KS	Kaposi's sarcoma
kV	kilovolt
L	litre
LAK	lymphokine-activated killer
LCIS	lobular carcinoma <i>in situ</i>
LDH	lactate dehydrogenase
LEMS	Lambert–Eaton myasthenic syndrome
LFT	liver function test
LH	luteinizing hormone
LHRH	luteinizing hormone-releasing hormone
LLN	lower limit of normal
mAb	monoclonal antibody
MAP	mitogen-activated protein
MBq	mega becquerel
MDR	multidrug resistance
MDS	myelodysplastic syndromes
MDT	multidisciplinary team
MEN	multiple endocrine neoplasia
mEq	milli equivalent
MeV	mega-electron volt
MFH	malignant fibrous histiocytoma
Mg <sup>2+</sup>	magnesium ion
MGMT	O <sup>6</sup> -methylguanine-DNA methyl transferase
MGUS	monoclonal gammopathy of uncertain significance
MHC	major histocompatibility complex
MI	myocardial infarction
MIBG	meta-iodobenzylguanidine
MIC	mitomycin, ifosfamide, cisplatin
MIU	mega international unit
mL	millilitre
MLC	multileaf collimator
MMC	mitomycin
mmol	millimole
mo	month



MOPP	mustine, vincristine, procarbazine, and prednisolone
6-MP	6-mercaptopurine
MPM	malignant pleural mesothelioma
MR	magnetic resonance
MRC	Medical Research Council
MRCp	magnetic resonance cholangiopancreatography
MRD	minimal residual disease
MRI	magnetic resonance imaging
mRNA	messenger ribonucleic acid
MSM	men who have sex with men
mSv	milli sievert
MTD	maximal tolerated dose
mTOR	mammalian target of rapamycin
MTX	methotrexate
MUGA	multigated acquisition
MV	megavolt
MVAC	methotrexate, vinblastine, doxorubicin, cisplatin
MVP	mitomycin, vinblastine, cisplatin
MZL	marginal zone lymphoma
Na <sup>+</sup>	sodium ion
NCI	National Cancer Institute
NCRI	National Cancer Research Institute
NCRN	National Cancer Research Network
NG	nasogastric
NHL	non-Hodgkin's lymphoma
NK	natural killer
NK <sub>1</sub>	neurokinin-1
NLPHL	nodular lymphocyte-predominant Hodgkin's lymphoma
NSAID	non-steroidal anti-inflammatory drug
NSCLC	non-small-cell lung cancer
NSE	neuron-specific enolase
NSGCT	non-seminomatous germ cell tumour
NWTS	National Wilms' Tumor Study Group
O <sub>2</sub>	oxygen
OAR	organ at risk
od	<i>omne in die</i> (once daily)
ONJ	osteonecrosis of the jaw
ORR	overall response rate
OS	overall survival
PCI	prophylactic cranial irradiation

PCNSL	primary central nervous system lymphoma
PCR	polymerase chain reaction
PD-1	programme death-1
PDGF	platelet-derived growth factor
PDGFR	platelet-derived growth factor receptor
PD-L1	programme death-1 ligand
PE	pulmonary embolus
PET	positron emission tomography
PFS	progression-free survival
Pgp	P-170 glycoprotein
PICC	peripherally inserted central catheter
PN	peripheral neuropathy
PNET	primitive neuroectodermal tumour
PO	<i>per os</i> (orally)
PO <sub>4</sub> <sup>3-</sup>	phosphate ion
PPI	proton pump inhibitor
PR	progesterone receptor
pRBC	packed red blood cell
prn	<i>pro re nata</i> (as needed)
PS	performance status; paraneoplastic syndromes
PSA	prostate-specific antigen
PSC	primary sclerosing cholangitis
PSTT	placental-site trophoblastic tumour
PTC	percutaneous transhepatic cholangiography
PTH	parathyroid hormone
PTHrP	parathyroid hormone-related protein
PTV	planning target volume
PVE	portal vein embolization
q	every
qds	<i>quater die sumendum</i> (four times daily)
QoL	quality of life
RBC	red blood cell
RCC	renal cell carcinoma
RCT	randomized controlled trial
RECIST	Response Evaluation Criteria in Solid Tumors
RFA	radiofrequency ablation
RIC	reduced intensity conditioning
RNA	ribonucleic acid
RTK	receptor tyrosine kinase
RTOG	Radiation Therapy Oncology Group

RT-PCR	reverse transcriptase polymerase chain reaction
SAS	subarachnoid space
SBP	solitary plasmacytoma of bone
s/c	subcutaneous
SCC	squamous cell carcinoma
SCF	supraclavicular fossa
SCLC	small-cell lung cancer
SCLL	small cell lymphocytic lymphoma
SD	standard deviation
SFLCR	serum free light chain ratio
SGPT	serum glutamic pyruvic transaminase
SIADH	secretion of inappropriate antidiuretic hormone
SIOP	International Society of Paediatric Oncology
SLE	systemic lupus erythematosus
SLNB	sentinel lymph node biopsy
SMC	Scottish Medicines Consortium
SNP	single-nucleotide polymorphism
SOB	shortness of breath
SPECT	single-photon emission computerized tomography
spp.	species
SRS	stereotactic radiosurgery
SVC	superior vena cava
SVCO	superior vena cava obstruction
SVT	supraventricular tachycardia
TACE	trans-arterial chemoembolization
TBI	total body irradiation
TBNA	transbronchial needle aspiration
TBq	tera becquerel
TCA	tricyclic antidepressant
TCC	transitional cell carcinoma
tds	<i>ter die sumendum</i> (three times daily)
TFT	thyroid function test
TG	thyroglobulin
6-TG	6-thioguanine
TGFA	transforming growth factor alpha
TGFB	transforming growth factor beta
TI	irradiation of the thorax
TK	tyrosine kinase
TKI	tyrosine kinase inhibitor
TME	total excision of the mesorectum

TNF	tumour necrosis factor
topo I	topoisomerase I
topo II	topoisomerase II
TRM	transplant-related mortality
TS	thymidylate synthase
TSH	thyroid-stimulating hormone
TTP	thrombotic thrombocytopenic purpura; time to progression
TURBT	transurethral resection of bladder tumour
TURP	transurethral resection of the prostate
U & Es	urea and electrolytes
ULN	upper limit of normal
USS	ultrasound scan
VATS	video-assisted thoracoscopic surgery
VC	vomiting centre
VEGF	vascular endothelial growth factor
vHL	von Hippel Lindau
VIP	vasoactive intestinal peptide
VOD	veno-occlusive disease
VTE	venous thromboembolism
WCC	white cell count
WHO	World Health Organization
wk	week
WT	Wilms' tumour
y	year

## Part 1

# Background

1	Aetiology and epidemiology	3
2	The genetics of cancer	17
3	Surgical oncology	31



# Aetiology and epidemiology

Genetic factors	4
Gender	6
External factors	8
Infections	12
Exposures	14
Further reading	16

## Genetic factors

- ~7 million deaths worldwide can be attributed to malignancy each year.
- The interplay between the hereditary and environmental risk factors underlying the development of malignancy is becoming clearer.
- It is thought that at least 50% of cases are preventable.
- 1° prevention strategies focus on modifiable lifestyle and environmental risk factors.
- Most cancers are thought to arise as monoclonal, i.e. a single cell accumulates sufficient mutations in key genes to cause uncontrolled cell proliferation.
- As cancers progress, in many cases, they gain new mutational events and may become more heterogeneous.
- Genes involved in the development of cancers fall into three categories.

### Tumour suppressor genes

- Genes whose function is lost during carcinogenesis.
- Both allele copies must be inactivated, before the tumour suppressor function is completely lost (absence of normal protein product), i.e. can be classified as recessive.
- Functional mutations result in loss of growth inhibitory mechanisms.
- Mutations can be hereditary (germline mutations) or acquired.
- An example of a tumour suppressor gene—the *p53* gene:
  - produces a transcriptional regulator involved in cell cycle control and maintaining genomic integrity
  - ~50% of human cancers possess *p53* mutations, including breast, lung, pancreas, colon, and brain tumours, and malignancies seen in the inherited Li–Fraumeni syndrome.

### Proto-oncogenes

- Genes whose function becomes enhanced in carcinogenesis.
- Usually play an essential role in controlling cell proliferation, encoding growth factors, growth factor receptors, transcription factors, etc.
- Mutations of oncogenes may impede normal cell cycle regulation, causing uncontrolled cellular replication.
- Mutation in only one of the proto-oncogene alleles is needed for the mutant gene product to influence downstream events, i.e. mutations are dominant at the cellular level.
- An example of a proto-oncogene—the *Ras* gene:
  - encodes a membrane-associated G protein responsible for cellular signal transduction
  - mutated *Ras* products remain activated, even in the absence of the appropriate growth factor receptor signal
  - mutations in *Ras* are implicated in 30% of all cancers, including melanoma, lung, and pancreas.

### DNA repair genes

- Genes whose usual function is to carry out DNA repair.
- Functional mutations of DNA repair genes accelerate the accumulation of mutated tumour suppressor genes and proto-oncogenes.



- An example of a DNA repair gene—the *ATM* gene:
  - encodes a protein involved in the detection of DNA damage, with an important role in cell cycle progression
  - multiple double-stranded DNA breaks lead to high rates of chromosomal rearrangements
  - produces the syndrome of ataxia–telangiectasia, associated with:
    - progressive cerebellar ataxia
    - ↑ incidence of malignancies (usually lymphomas/leukaemias)
    - hypersensitive response to treatment with ionizing radiation.

The relative contribution of the genetic mutation to the cancer varies.

### Specific genes that confer a high probability of susceptibility to specific cancers

- Comprise at least 5% of the total incidence of fatal cancers.
- Usually:
  - highly penetrant
  - dominantly inherited.
- Examples include:
  - *BRCA1/2* genes—mutations account for the majority of hereditary breast carcinomas. ♀ carriers have 55–85% lifetime risk of breast carcinoma, and 40% (*BRCA1*) or 18% (*BRCA2*) lifetime risk of ovarian cancer. ↑ incidence of pancreatic, ♂ breast, and prostate cancers also reported
  - *RB1* gene—on chromosome 13. Encodes a nuclear protein, which acts as a tumour suppressor. Mutations may be hereditary or acquired. Inactivation of both alleles causes retinoblastoma
  - *APC* gene—on chromosome 5. Mutations result in familial adenomatous polyposis (FAP), which classically causes the development of numerous colonic adenomas, with subsequent malignant transformation.

### Genes with modest effects that may interact with environmental factors

- For example, tumour viruses expressing genes that disrupt the activity of tumour suppressor genes.

### Genetic (somatic) mutations caused by recognizable carcinogens causing sporadic cancers

- Many exogenous carcinogens cause somatic mutations.
- Examples include:
  - aromatic hydrocarbons
  - ultraviolet (UV) radiation.

### Other factors

- More recently, it has become clear that mutational events alone only tell part of the story. The science of *EPIGENETICS* has established that other modifications can occur in the genetic code, which influence gene expression. In addition, post-translational modification of proteins can also play a significant role.

## Gender

- Many cancers occur more frequently in one or other sex, e.g. stomach cancer—twice as frequent in men.
- It is difficult to distinguish innate differences in susceptibility from differences caused by other risk factors, e.g. the greater incidence of carcinoma of the bladder in men was thought to represent an innate difference in susceptibility—but, when exposed to the same occupational carcinogens and tobacco smoke, women are at least as susceptible to the disease.



## External factors

### Smoking

- Tobacco smoking is:
  - the most important known carcinogen
  - the largest single avoidable cause of premature death in the developed world.
- 15% of all cancer cases worldwide, and >30% of cases in men from developed countries, are attributed to smoking.
- Associated particularly with lung cancer, which is the commonest cause of cancer death. Smoking is responsible for ~90% of cases of lung cancer. The relative risk in a lifelong smoker, compared to a lifelong non-smoker, is between 10- and 30-fold, depending on the intensity and duration of exposure. It has been estimated that smoking was responsible for 0.85 million avoidable deaths from lung cancer in 2000 worldwide.
- Also has a definite causative role in many other cancers, including:
  - mesothelioma
  - myeloid leukaemia
  - gastrointestinal (GI) tract, including the oral cavity, oesophageal, gastric, and pancreatic
  - ear, nose, and throat (ENT), including pharyngeal, laryngeal, and nasopharyngeal, and cancers of the nasal cavity and paranasal sinuses
  - urinary tract, including bladder and renal
  - liver
  - cervical.
- Cigarette smoking has a synergistic (multiplicative) effect on the risk of development of neoplasms caused by other carcinogens, e.g. alcohol, asbestos.
- A substantial increase in the cancer burden may be expected, unless measures to control consumption are strengthened—a consequence of the ongoing increase in global cigarette consumption, especially amongst women and in developing countries.
- Smoking cessation reduces the risk of cancer, but programmes promoting cessation have had only limited success.
- Passive exposure to tobacco smoke also contributes. Estimates are that 15–30% of lung cancer in patients who have never smoked can be attributed to environmental tobacco smoke exposure.

### Alcohol

- Alcohol is implicated as causative in several malignancies, including:
  - *head and neck cancer, and cancer of the oropharynx*—the risk increases linearly with alcohol intake
  - *oesophageal cancer*, particularly squamous—the risk is strongly related to alcohol intake and again appears to be increased, even at low levels of consumption
  - *breast cancer*—studies suggest that moderate to heavy alcohol intake (>2 units/day) is associated with an increased incidence of carcinoma of the breast; 2–10% of all breast cancers may be related to alcohol intake. The mechanism of carcinogenesis is unclear, but it is thought it could be related to an increase in circulating oestrogens and androgens

- *hepatocellular carcinoma (HCC)*—moderate to heavy drinking is a risk factor for alcoholic cirrhosis, and this is a risk factor for hepatocellular cancer. Excessive alcohol intake in the absence of cirrhosis has a less clear role.
- A confounding factor in many studies is that excess alcohol intake has a positive association with tobacco consumption. These two factors can have a synergistic, rather than additive, effect on cancer incidence, but the association between the two can make assessment of the relative contribution of each difficult to elucidate.

## Diet

### Obesity

- Adult obesity is a risk factor for many solid tumours, including:
  - endometrial cancer
  - post-menopausal breast cancer
  - cancer of the kidney
  - oesophageal carcinoma
  - colorectal carcinoma.
- Has also been suggested to contribute to the development of prostate, liver, ovarian, gastric, and pancreatic malignancies.
- May have a role in up to 20% of cancer deaths in the developed world.
- The mechanisms underlying the association between obesity and malignancy are poorly understood.
- The epidemic of obesity in the developed world will undoubtedly increase the cancer burden in those populations.

### General dietary risk factors

- High levels of vegetable consumption appear to be associated with a reduced risk of colon cancer, particularly distal tumours, although the prospective evidence is not strong.
- Consistent evidence that a high intake of vegetables and fruit reduces the risk of other tumours is lacking.
- High levels of red meat consumption appear to increase the risk of colonic and rectal cancer.
- A high-fibre diet has previously been reported as being associated with a lower risk of carcinoma of the colon. However, these results may have been influenced by confounding dietary factors, such as folate intake, and the association has not been confirmed.
- Fat consumption—there is ongoing interest in whether the various types of dietary fats influence cancer risk differently, with most concern over the saturated and trans fats found in meats and some dairy produce.

### Specific dietary risk factors

- Appropriate dietary modifications may significantly influence the incidence of certain cancers.
- Examples include:
  - *salt fish*—reducing the intake of salt fish could reduce the incidence of nasopharyngeal cancer in developing countries by 33–50%
  - *aflatoxins*—a mycotoxin produced by *Aspergillus* species of mould which frequently contaminates corn, peanuts, and soybeans. Halving the median daily intake of aflatoxins may reduce the incidence of HCC in Africa and Asia by up to 40%.

**Exercise**

- Physical inactivity appears to be associated with an increased risk of many adult tumours.
- Current evidence is greatest for breast and colonic cancers.
- The benefit of increasing exercise appears to be independent of associated obesity.
- Benefit also exists in reducing recurrence rates and improved outcomes in patients who adopt an exercise programme, even after the cancer diagnosis—the evidence being strongest in breast cancer.



## Infections

Sixteen per cent of the worldwide incidence of cancer is due to infection. For developed countries, the proportion is 9%, and for developing countries >20%.

### Viral infections

- Most tumour viruses are ubiquitous; the prevalence of infection is much higher than the incidence of their respective form of tumour.
- The development of associated tumours requires many years of infection.
- Viral infection plays a significant role in the initial step towards carcinogenesis. However, other co-factors are necessary for the development of virally linked tumours, including genetic, immunological, and environmental factors.
- Some viruses increase the risk of multiple malignancies (see Chapter 28).
- Other viruses are directly linked to human tumours. Examples include the following.

#### *Human papillomavirus*

- The most frequent sexually acquired infection in the developed world.
- Genital infection is via unprotected sexual intercourse or close contact with an infected area.
- Small, double-stranded DNA viruses (*Papovaviridae* family).
- Specifically infect squamous epithelial cells.
- >100 different genotypes identified.
- Human papillomavirus (HPV) infection accounts for >80% of cervical cancers worldwide.
- Also associated with vaginal, vulval, penile, and anal carcinoma.
- Strongest evidence for carcinogenicity is for HPV types 16 and 18 (cervical cancer).
- A quadrivalent vaccine is now available for girls/unvaccinated women; a national (United Kingdom, UK) programme for immunization has been introduced. Cervical screening programmes in developed countries have reduced the incidence of cervical carcinoma.

#### *Hepatitis B and C virus*

- 81% of cases of HCC are attributable to chronic infection.
- 75% with 1° hepatitis B virus (HBV) infection develop lifelong hepatic infection → hepatocellular injury → chronic hepatitis.
- Chronic HBV infection is associated with ↑ 100-fold risk of HCC.
- The prevalence of HBV carriers in South East Asia, China, and sub-Saharan Africa may be >20%.
- Modern antiviral therapies can now eradicate chronic infection and hold promise of reducing the incidence of HCC dramatically in the future.



### Epstein–Barr virus

- An endemic *Herpes* virus.
- Hodgkin's lymphoma (HL)—Epstein–Barr virus (EBV) may account for:
  - up to 60% of Hodgkin's disease in developed countries
  - ≥80% in developing countries.
- Burkitt's lymphoma (BL):
  - EBV is thought to be causative in >90% of BL in equatorial Africa (>90% of children are infected with EBV by the age of 3y, and Burkitt's is the most common childhood malignancy)
  - has a lesser role elsewhere (<25% of cases outside Africa, the Middle East, and South America)
  - malaria infection is considered a co-factor in the genesis of BL. Putative mechanisms for this include chronic stimulus for B-cell proliferation or depression of cytotoxic T-cell function, such that EBV infection may escape T-cell surveillance.
- Greater uncertainty about the role of EBV in other types of non-Hodgkin's lymphoma (NHL).
- Highly consistent association with nasopharyngeal carcinoma. EBV can be found in every anaplastic nasopharyngeal carcinoma cell.

### Bacterial infections

#### *Helicobacter (H.) pylori*

- Clear association between *H. pylori* infection and gastric adenocarcinoma.
- One-third of gastric adenocarcinomas in developed countries can be attributed solely to *H. pylori*, and this figure is likely to be closer to 50% in developing countries.
- The mechanism of carcinogenesis is not fully understood.
- *H. pylori* is also likely to have a role in the development of gastric lymphoma.
- Different strains may have different carcinogenic potential.

### Parasitic infections

#### *Schistosomiasis haematobium (bilharzial bladder disease)*

- Linked to hyperplasia, metaplasia, dysplasia, and invasive carcinoma of the bladder.
- 8% of cases of bladder cancer in the developing world may be attributable to infection—the majority of which are squamous cell.
- It is not relevant in bladder cancer seen in the developed world.

## Exposures

### Solar exposure

- Over 1 million cases of skin cancer are diagnosed worldwide each year.
- Epidemiological evidence suggests >90% of malignant melanoma is attributable to solar radiation.
- The most frequent 1° sites are areas exposed intermittently, but intensely, e.g. skin of the back.
- Australians (mostly white and intensely exposed to UV radiation) have the highest incidence of melanoma in the world.
- Sun exposure in childhood is a particular risk factor.
- Exposure to solar radiation is also likely to account for the great majority of non-melanoma skin cancer.
- Basal cell carcinoma (BCC) and squamous cell carcinoma (SCC) are associated with cumulative sun exposure, typically in maximally sun-exposed areas, e.g. face and ears.

### Other radiation exposure

- The initiating factor in carcinogenesis is probably a mutation in a tumour suppressor/proto-oncogene → aberrant loss/gain of function.
- High-dose exposure:
  - doses of 500–2000mSv are known to be carcinogenic, potentially causing several malignancies, e.g. acute leukaemias, thyroid cancer
  - exposures of this magnitude are unusual—much of the data come from complex epidemiological studies performed in the wake of Nagasaki, Hiroshima, and Chernobyl, or from studies of second malignancies in patients previously treated for cancer.
- Low-dose exposure:
  - the average per capita dose from all sources of ionizing radiation is ~3.4mSv per year (~88% from natural sources and the remainder primarily from medical exposures)
  - most data have been collated from studies on 2° malignancies in survivors previously treated with radiotherapy and epidemiological studies of miners
  - extrapolation from data on exposure to ≥500mSv suggests that 1–3% of all cancers may be attributable to radiation arising largely from natural sources.
- Radiation sensitivity:
  - ~3% of the population show undue sensitivity to conventional doses of ionizing radiation without any obvious pre-treatment phenotype, apart from the presence of cancer. This group is at risk of excess toxicity from standard radiation therapy regimens. Greater understanding of underlying defects in DNA repair, cell cycling, and DNA damage signal transduction would allow appropriate tailoring of therapy
  - rare radiosensitivity syndromes also exist, predisposing to early development of cancer, e.g. ataxia–telangiectasia, Bloom’s syndrome. Susceptibility to DNA damage is enhanced, and both radiotherapy and chemotherapy regimes need adjustment accordingly.

## Other exposures

Other exposures account for <5% of the cancer burden. Many chemical carcinogens have been identified.

### *Industrial exposure*

- Dye/textile workers (naphthylamines)—bladder cancers.
- Chemical, rubber workers (benzene)—haematological malignancies.
- Asbestos exposure—lung cancer, mesothelioma (notifiable).

### *Pharmacological exposure*

- Many chemotherapeutic agents used in the treatment of cancer are carcinogenic, e.g. alkylating agents.
- High-dose diethylstilbestrol during pregnancy (used in the 1960s to reduce the risk of miscarriage) → a small percentage of ♀ offspring developed clear cell carcinoma of the vagina, as they reached the menarche.

### *Environmental exposure*

- Few causal links with environmental pollutants have been firmly established.
- Estimates suggest ~1% of lung cancer deaths (United States (US) figures) are attributable to air pollution.
- The incidence of many cancers varies greatly between geographical areas—this includes variations between countries and between different regions within countries.
- Variations reflect complex interactions between genetic, environmental, economic, and behavioural factors.
- Migration between areas of contrasting incidence → the migrant population usually acquires the cancer pattern of their adopted country, i.e. environmental, rather than genetic, factors dominate, except in rare familial cases.
- Cancer incidence can vary between socio-economic groups.
- Epidemiological studies help in further understanding of the aetiology of different cancers and allow the development of strategies for disease prevention.

## Further reading

Coyle YM (2009). Lifestyle, genes and cancer. *Methods Mol Biol* **472**, 25–56.

Danaei G, Vander Hoorn S, Lopez AD, et al. (2005). Causes of cancer in the world: comparative assessment of nine behavioural and environmental risk factors. *Lancet* **366**, 1784.

Dumitrescu RG (2009). Epigenetic targets in cancer epidemiology. *Methods Mol Biol* **471**, 457–67.

Jemal A, Siegel R, Ward E, et al. (2008). Cancer statistics 2008. *CA Cancer J Clin* **58**, 71.

Schottenfeld D, Fraumeni JF (eds.) (2006). *Cancer epidemiology and prevention*, 3rd edn. Oxford: Oxford University Press.

# The genetics of cancer

- Introduction to genetics of cancer 18
- 'The cancer phenotype' 19
- Oncogenes and tumour suppressor genes 20
- Driver and passenger mutations 22
- Synthetic lethality/induced vulnerabilities mediated by oncogenes and tumour suppressors 23
- Multistep carcinogenesis 24
- Genetic predisposition to cancer 25
- Predictive genetic testing 26
- Common cancer predispositions 27
- Bowel cancer family history 28
- Low-risk alleles 30

## Introduction to genetics of cancer

Over the past 10 years, the advent of high-throughput sequencing technology has revolutionized cancer genetics. Whole cancer genomes can now be determined in a matter of hours. Allelic variations that predispose to cancer, some as little as 2-fold, have been determined in larger-scale population studies. With these increased data comes the need to understand the biological meaning of all these changes and the implications this will have for cancer therapy. This chapter reviews some of the successes (e.g. *BRAF* mutation identification and targeted treatment in melanoma) but also reviews the challenges that now face the community.

## 'The cancer phenotype'

Cancer arises following the accumulation of mutations to the DNA. These mutations are thought to subvert normal tissue processes that protect against tumourigenesis. Cancers that arise from the epithelium are the most common, and much investigation has focused on the reasons why cancers form in these tissues and on the protective mechanisms from which cancer cells have to escape. For example, in rapidly renewing tissues, such as the intestinal epithelium, cancer cells need to escape from the normal sloughing off process and the terminal differentiation that occurs. Other processes that cancer cells require are more generic: the need to escape from immune cell killing, the development of a blood supply, the ability to grow in the absence of growth factors and survive energetic stress, and the resistance to cell death stimuli. Finally, cancer cells gain the ability to invade out of tissues, survive in the circulation, and then grow at 2° sites such as the liver. For an excellent review of the factors or 'hallmarks' required by cancer cells, see references 1 and 2. It should be noted that, more recently, the ability of cancer cells to subvert the normal cells of the body has become evident. In pancreatic ductal adenocarcinoma, up to 80% of cells within the tumour are non-cancer cells or stroma. These stromal cells which include specific immune cells (such as macrophages), fibroblasts, and endothelial cells are all vital for the growth of the tumour and can also play an important role as a physical barrier, stopping optimal drug penetration. They may also provide important survival factors that could stop targeted therapies from working.

1 Hanahan D, Weinberg RA (2000). The hallmarks of cancer. *Cell* **100**, 57–70.

2 Hanahan D, Weinberg RA (2011). Hallmarks of cancer: the next generation. *Cell* **144**, 646–74.

## Oncogenes and tumour suppressor genes

There are two classes of genes that are mutated in cancer: oncogenes and tumour suppressor genes.

### Oncogenes

These are genes encoding proteins whose expression normally leads to a proliferative phenotype and suppression of apoptosis. One of the most classical families of oncogenes is the *RAS* family (*HRAS*, *KRAS*, and *NRAS*). *RAS* family proteins act downstream of growth factor signalling pathways, e.g. epidermal growth factor receptor (EGFR) signalling, and, following stimulation of these pathways, *RAS* is activated by switching from the inactive guanosine diphosphate (GDP)-bound form into the active guanosine triphosphate (GTP)-bound form. Normally, this requires the activity of an upstream *RAS* GEF protein such as *SOS*; however, when *RAS* is mutated, via mutations in codons 12, 13, and 61, it is permanently locked in the active GTP-bound form, allowing growth factor-independent signalling. Other common oncogenes in cancers are *BRAF*, *RET*, *SRC*, *ERBB2/3*, and *MYC*. Many mechanisms, in addition to mutation, can lead to the overexpression of these to drive cancer. For example, amplifications of genes, such as *ERBB2* in breast and *SRC* in colon cancer, are common and lead to high levels of expression. Chromosomal fusions can cause oncogenes to be fused to highly expressed tissue specific promoters, resulting in overexpression of the oncogene in those tissues. Moreover, the expression of oncogenes can often be a direct consequence of other signalling pathways that are deregulated in cancer. For example, *MYC* is a target of both the *RAS* and Wnt pathways, which are often activated in cancer.

### Tumour suppressor genes

Tumour suppressor genes broadly fall into two classes. The first set includes those genes that drive apoptosis or block proliferation and growth by inhibition of key signalling pathways. The second set comprises those genes that are required for DNA damage repair, the loss of which leads to a 'mutator' phenotype.

Over the past 10 years, our definition of tumour suppressor genes had broadened. Previously, to be classified as a 'bona fide' tumour suppressor gene, both copies of the gene would need to be mutated in cancer. Moreover, it was thought that tumour suppressor genes would be associated with an inherited disease syndrome. For example, germline mutations of the tumour suppressor genes *TP53*, *APC*, and *PTEN* lead to Li-Fraumeni syndrome, FAP, and Cowden disease, respectively. Patients with these syndromes carry a mutant copy throughout their body and develop cancer in a tumour-prone tissue upon the loss of the remaining allele. Li-Fraumeni syndrome patients develop predominantly breast cancers, whilst FAP patients develop predominantly colon cancer. The precise reason for the particular tissue type affected is a subject of much study, but generally it is thought that a specific tumour suppressor may be particularly important in that tissue type. This is particularly clear for the adenomatous polyposis coli (*APC*) protein, as its function is to negatively regulate the Wnt signalling pathway that is essential for the control of intestinal homeostasis but



is less important in other tissues. Mechanistically, tumour suppressors, such as *APC* and *PTEN*, play key roles as negative regulators of important growth factor signalling pathways, so that loss of these genes leads to growth factor-independent pathway activation (very similar to the situation of *RAS* mutation). Although the most commonly mutated tumour suppressor gene is *TP53*, the precise function of the p53 protein required for tumour suppression is still unclear. Loss of p53, a transcription factor, leads to failure to induce apoptosis and growth arrest, following DNA damage, increased genomic instability, impaired DNA repair, alteration in homeostasis, and changes in metabolism, all of which could be important for tumour progression. In addition, mutation in *TP53* can often lead to a non-functional, but very stable, protein that carries oncogenic properties.

Through its ability to bind to other family members, e.g. p63 and p73, mutant p53 can interfere with the functions of these proteins and drive invasion and metastasis. Given the myriad of functions of p53, the reason for loss or mutation may vary from tumour to tumour and may be very dependent on the oncogene that initiated the tumour and the precise stage of tumourigenesis. This will be discussed more in the multistep model of tumourigenesis (see  Multistep carcinogenesis, p. 24).

The second class of tumour suppressor genes, those whose loss leads to a 'mutator' phenotype due to DNA repair defects, includes *BRCA2/BRCA1* and the mismatch repair family genes *HMSH2* and *HMLH1*. The proteins encoded by these genes play important roles in non-homologous end joining and mismatch repair, respectively. *BRCA1/2* mutations increase the familial risk of breast, ovarian, and, to a lesser extent, pancreatic cancer, whilst mutations in the mismatch repair proteins predominantly predispose to colorectal cancer. Interestingly, nearly all breast tumours that arise within *BRCA* carriers sporadically mutate *TP53*, presumably to allow the *BRCA* loss-driven instability to be tolerated. Although rarely mutated in sporadic cancer, *HMLH1* is often epigenetically inactivated via methylation in a large proportion of colorectal cancers that exhibit microsatellite instability, a hallmark of mismatch repair deficiency.

## Driver and passenger mutations

The recent sequencing efforts headed by the International Cancer Genome Consortium (ICGC) have now resulted in the publication of many different cancer genomes. This led to a redefinition of what constitutes a pathogenic mutation in cancer. In tissues that are constantly exposed to mutagens, e.g. the skin or intestine, tumours arise with hundreds of mutations. It is unlikely that all these mutations are driving cancer progression, and thus the concept of 'driver' and 'passenger' mutations has emerged. Driver mutations must be frequent and induce changes in the gene sequence that alters the protein encoded by that gene. Pathogenic mutations result in a loss of function, e.g. nonsense mutations or frameshifts that stop protein production, or arise in 'hot spots' and result in aberrant activation like those that occur in codon 12 of *KRAS*. Passenger mutations are those that do not alter protein coding and generally occur at very low frequencies. In practice, the definition of driver and passenger mutations may be difficult. In a cancer type with a high mutation rate, for example, a particularly large gene may be mutated in a significant fraction of the disease (e.g. 10%) but may still only be a passenger mutation. Moreover, in following cancer treatment, a passenger mutation that may only be present at a low frequency in a subset of tumour cells might confer a selective advantage and drive resistance and hence switch from a passenger mutation to a driver.

Therefore, following the detection of mutations in cancer, it is fundamentally important to functionally understand the consequences of these mutations. This can be done through manipulation in cell lines, in 1° tumours, or in proof of principle genetically engineered mouse models where those mutations can be targeted to the same tissues of the mouse. It should also be noted that, rather than an individual gene being mutated in a particular cancer, sometimes many nodes on the same pathway might be mutated. Indeed, recent sequencing studies have shown that one of the most commonly mutated pathways in cancer is the 'axon guidance pathway'. Although the functional significance of these mutations is still unclear, these sequencing initiatives have revealed the previously unappreciated importance of this pathway in cancer.

## Synthetic lethality/induced vulnerabilities mediated by oncogenes and tumour suppressors

One of the aims of sequencing is to identify mutations that may allow targeting of the pathways activated by those mutations with specific inhibitors. This has led to the concept of an 'actionable mutation'. In 2002, one of the first sequencing studies identified that *BRAF* was commonly mutated in melanoma. Within 10 years of this publication, *BRAF* kinase inhibitors had been developed, trialled, and licensed for clinical practice in melanoma. Importantly, these inhibitors were ineffective in melanomas lacking *BRAF* mutation. Although resistance to these inhibitors is acquired rapidly, their development shows how quickly information can be translated to the clinic. Other oncogenes/tumour suppressor events that have allowed targeted treatment include *HER2* overexpression, which renders cancers responsive to a blocking antibody trastuzumab, and *BCR-ABL* fusions in chronic myeloid leukaemia (CML) allowing targeted treatment with imatinib and other *ABL* inhibitors.

Many mutations that occur, however, cause loss of function, and, despite efforts in gene therapy, restoring proteins that are lost is not currently feasible. As mentioned previously, the loss of some tumour suppressors leads to the activation of pathways that might be druggable, e.g. *APC* loss activating Wnt signalling and *PTEN* loss activating phosphatidylinositol-3 (PI3) kinase signalling. In many cases, however, the loss of proteins like p53 or *BRCA1/BRCA2* does not immediately indicate a pathway to target. This has led to many small molecule and ribonucleic acid interference (RNAi) screens to identify 'synthetic lethality' or 'induced vulnerabilities' in cancer cells lacking tumour suppressor genes, by a non-biased method. Probably the most elegant example of synthetic lethality was revealed in DNA repair-defective *BRCA1/2*-deficient cells. The use of inhibitors of poly (adenosine diphosphate-ribose) polymerase (PARP) to target a compensating DNA repair pathway in these cells resulted in cell death, whilst having no effect on normal cells or *BRCA*-proficient cells. Although PARP inhibition is not yet licensed in patients with breast cancer, *BRCA1/2*-deficient cells also showed heightened sensitivity to platinum-based cytotoxics such as carboplatin and cisplatin, which are used clinically.

Despite intense research, very few other kinase inhibitors have worked as single agents in clinical trials, even when key pathways have been inhibited downstream of an oncogenic mutation. Moreover, despite hundreds of publications on synthetic lethality, very few therapies based on this approach have made it into the clinic. There will be many reasons for this, but it is important to remember that, given the high mutational burden in human cancers, none of these mutations occur in isolation. Furthermore, many pathways that drive resistance to targeted agents *in vivo* might be derived not only from aberrant signalling within the tumour cells, but also from surrounding stromal cells.

## Multistep carcinogenesis

The concept of driver mutations may have originated from sequencing studies, but, for over 20 years, it has been evident that certain mutations are common in specific cancers. *APC* is mutated in ~80% of colorectal cancers, whilst *KRAS* is mutated in up to 95% of pancreatic ductal adenocarcinomas. These very common mutations are thought to be the initiating event in tumourigenesis in these tissues where they cause benign lesions that alone would not progress to cancer. Within the colon, polyps very commonly have *APC* mutations, and, within the pancreas, pre-malignant pancreatic intraepithelial neoplasias (PanINs) have *KRAS* mutations. Benign naevi of the skin, the presumed precursors to melanoma, very often harbour *BRAF* mutations. However, it is the acquisition of further mutations that drives progression from the benign to malignant state. Second hits are often thought to occur as a direct consequence of the initiating oncogene. For example, both *KRAS* and *BRAF* mutations are known to induce senescence/growth arrest, following the initiation of benign lesions, and hence genes encoding proteins that can abrogate senescence, such as *p16*, *PTEN*, and *p53*, are often mutated in pancreatic cancer and melanoma to drive tumour progression.

Of all cancers, the multistep carcinogenesis model has been best exemplified in colon cancer where, following *APC* mutation, further mutations occur in *KRAS*, *TP53*, and genes in the transforming growth factor beta (TGF $\beta$ ) and PI3 kinase pathways to drive progression. Most colon cancers will have mutations in at least three, out of five, of these pathways. It is interesting to note, however, that, although many mutations in colon cancer arise outwith these five major pathways, it has been hard to classify their roles in tumour progression. Further studies in these pathways will be important.

## Genetic predisposition to cancer

Epidemiological studies of most cancers have demonstrated a moderate (2–3 times) increase in risk among first-degree relatives of affected individuals. In a minority, this may represent families where an inherited gene alteration confers a high risk of developing a specific cancer; in others, relatives may have an increased susceptibility to developing cancer in response to environmental carcinogens or may simply share environmental risk factors.

Familial cancers may be recognized by:

- the occurrence of rare tumours known to be genetic, e.g. bilateral retinoblastoma
- associated phenotypic features, e.g. multiple polyps in FAP, mucosal pigmentation in Peutz–Jeghers syndrome, or chromosome breakage in a DNA repair disorder.

In other situations, clues must be sought from the family history:

- unusually early age of onset of the tumour
- multiple or bilateral tumours
- familial clustering of the same tumour type or of related types (such as breast and ovary, or colon and uterus).

In general, the following may raise suspicion of a familial predisposition:

- three or more close relatives (on the same side of the family) with the same common cancer (or related cancers)
- two or more close relatives (on the same side of the family) with the same common cancer (or related cancers) where one is affected under 50 years
- one close relative with early-onset cancer, e.g. breast cancer under 40 years, bowel cancer under 45 years
- one close relative with multiple 1° cancers
- two or more relatives with the same uncommon cancer, e.g. sarcoma, glioma, pancreatic cancer, etc.

Such families should be referred to clinical genetics services, so that the family histories can be verified and risk assessments performed. Sometimes, clinical examination may be needed to seek features of a specific genetic syndrome such as Cowden syndrome (mucosal ‘cobblestone’ papules, facial trichilemmomas, acral keratoses, craniomegaly), Gorlin syndrome (hyper-telorism, frontal bossing, palmar and plantar pits), or neurofibromatosis (café-au-lait patches, cutaneous neurofibromas, axillary freckling). More commonly, there are no specific signs, and assessment is based on the family history itself, but, if appropriate, cancer surveillance can be arranged for at-risk relatives, although evidence of its effectiveness is often lacking, and recruitment to trials is important, where available.

In a small number of families, molecular genetic testing may be possible, but only where the causative germline mutation can be identified in a blood sample from an affected relative. Thus, for many families, no genetic test is possible, either because the family is not thought likely to harbour a mutation in a known predisposition gene, a sample is not available from an affected relative, or analysis of the relevant predisposition genes has not identified the causative mutation in the family.

## Predictive genetic testing

Where a mutation has been identified in a family and consent to share the results is available, relatives can be offered a genetic test to find out whether they have inherited the familial predisposition. This would normally be offered via a clinical genetics service, after consultation with a genetic counsellor and with sufficient time to consider all the implications. It is important for the individual to appreciate that a positive result does not make cancer inevitable, and a negative result is not a guarantee against cancer developing. However, it may help guide who needs surveillance, allow decisions to be made about potential risk-reducing surgery, and clarify the risks to the next generation. The potential for psychological distress and for the effect of the findings on other family members, as well as on the individual being tested, should all be considered. There have been concerns that there may be implications for insurance premiums, which has led to guidelines being drawn up to address these issues in the UK and elsewhere.

### Implications of genetic testing for the affected individual

Much of the discussion around predictive genetic testing is often focused on the healthy 'at-risk' individual in the family, rather than on the affected relative whose blood is needed to start the testing process. There may be implications for the affected individual as well that need to be considered:

- many genetic analyses result in a negative result, as no mutation has been identified, but this should NOT be taken to mean that there is no genetic predisposition in the family, merely that it has not been identified
- sometimes, no clear result is obtained, i.e. a 'sequence change' is found in the individual's blood, but it is unclear whether this is a benign variant or pathogenic, and further testing may be needed to try to understand its significance
- a positive result may cause some distress to the affected individual, and feelings of guilt if this has been passed on to other family members, especially children
- there may be implications for the individual themselves, such as an increased risk of metachronous cancers or of cancers at associated sites which may not have been foreseen from the family history (e.g. ovarian cancer risk where a *BRCA1* mutation is found in a breast cancer family).

## Common cancer predispositions

### Breast cancer family history

(See ↻ Genetics of breast cancer, p. 266.)

Concern about a family history of breast cancer is a common referral to both clinical genetics and breast clinics. Many women can be reassured if there is a single relative affected over the age of 40 years, or two relatives but on different sides of the family.

Where it appears that there may be a 'moderate' increase in risk, mammographic surveillance under the age of 50 years may be offered, but, in most families, genetic testing is unlikely to be useful. This is because the majority of families, if they do harbour breast cancer predisposition genes, will have genes conferring low or moderate increased risk, which are not yet identified or amenable to testing. It may be appropriate to store samples from affected relatives, if they wish to do so, or submit such families to research studies with the aim of identifying these genes. An exception may be for families in whom there is Ashkenazi Jewish ancestry, where specific mutations in *BRCA1* and *BRCA2* genes are more likely, and testing for these could be offered after counselling.

For families where there is a higher likelihood of a predisposition gene and where an affected relative is willing to give a blood sample, genetic analysis for the two major high-risk genes *BRCA1* and *BRCA2* can be offered. At present, this is suggested where the chance of identifying a mutation is estimated to be at least 20%, which would include most families with ovarian, as well as breast, cancers, families with two breast cancers under 30 years, three breast cancers under 40 years, or four breast cancers under 50 years. Occasionally, testing for other genes, such as *PTEN* (Cowden syndrome) or *p53* (Li-Fraumeni syndrome), may be considered, depending on the spectrum of cancers that have occurred in the family.

Where a woman is found to carry a *BRCA1* or *BRCA2* gene mutation, options include mammographic and magnetic resonance imaging (MRI) surveillance, or risk-reducing surgery, and the risk to the ovaries must also be considered.

## Bowel cancer family history

An increased risk of bowel cancer may occasionally be due to a recognizable syndrome, identified by the presence of polyps, such as FAP or one of the hamartomatous polyp syndromes (Cowden syndrome, Peutz–Jeghers, juvenile polyposis), and genetic testing can find the causative mutation in the majority of these conditions.

Where adenomatous polyps are present in significant numbers, the conditions to consider are:

- FAP—classically over 100 polyps are present in the bowel
- attenuated FAP—presents with fewer than 100 polyps, with an older onset, but still has a high risk of progressing to bowel cancer and the risk for upper GI malignancy. Both of these conditions are autosomal dominant and due to mutations in the same gene, but the site of the mutation determines the phenotype
- *MYH*-associated polyposis—this is an autosomal recessive predisposition to adenomatous bowel polyps, so usually presents with a history of bowel cancer in siblings within the family. The majority of affected individuals have one or both of two common mutations within the *MYH* gene, so testing is relatively straightforward.

More commonly, a bowel cancer predisposition is marked only by the familial aggregation of bowel cancer cases, with fewer polyps, and hence is known as hereditary non-polyposis colon cancer (HNPCC), also referred to as Lynch syndrome. In most cases where a genetic predisposition is proven, this is due to a mutation in one of the mismatch repair genes (as described previously), *MLH1*, *MSH2*, *MSH6*, or *PMS2*. The genetic defect leads to defective mismatch repair of DNA, which leads to an increase in the mutation rate and faster progression of bowel polyps to cancers. Another consequence is microsatellite instability, which can be observed in the laboratory in tumour tissue and can be used to identify patients in whom a mismatch repair mutation is more likely.

Thus, for individuals concerned about their family history of bowel cancer, the family history can be assessed. Those with only one affected relative over the age of 45 years, or two relatives who are over 55 years, or on different sides of the family may be reassured. Where the family appears to be at 'moderate' risk (one relative under 45 years, two relatives where one is under 55 years at diagnosis, or three affected relatives at any age), permission is sought to access tumour tissue from one of the affected relatives. If this shows microsatellite instability, it may indicate a mismatch repair mutation is present. In this situation, the tumour tissue is also tested to see if there is loss of expression of the mismatch repair proteins, which may help guide which gene to analyse first, and, if blood is available from the affected individual, the commonly involved mismatch repair genes are analysed (*MLH1* and *MSH2*). The tumour may also be tested for the common *BRAF* mutation (V600E) found in sporadic bowel cancers with *MLH1* promoter hypermethylation and microsatellite instability, as finding this mutation would make it unlikely a germline mutation would be found.



Where the family fits the 'Amsterdam criteria' for a high risk of harbouring a mutation, the mismatch repair genes may be analysed, irrespective of the tumour analysis. (These families have at least three individuals with bowel cancer in two generations of the family, where at least one is affected under the age of 50 years, and familial polyposis excluded.)

If a mutation is found, then relatives can be offered genetic testing to guide surveillance. In the absence of a genetic test, those families thought to be at 'moderately' increased risk are offered colonoscopic surveillance, which may involve a single examination at presentation and a repeat at the age of 55 years, whereas those who are thought to be at 'high risk' of harbouring a predisposition gene (or known gene carriers) are offered 2-yearly colonoscopies from the age of 25 or 35 years, depending on the family history. For families with known mismatch repair genes, the risk of endometrial cancer (40%+) in the women must be remembered, and surveillance for other cancers may also be appropriate (e.g. gastric cancer in the over 50s).

## Low-risk alleles

More recently, Genome-Wide Association Studies (GWAS) have identified low-risk alleles in the population. These are often single-nucleotide polymorphisms (SNPs) that may occur anywhere in the genome. They are often found in promoter regions of genes or in introns that had not been previously linked to a familial disease. Interestingly, in colon cancer, many of these polymorphisms have been found in established oncogenic or tumour suppressor pathways. For example, polymorphisms have been found in promoters or introns of the *MYC* oncogene and bone morphogenetic protein (BMP) signalling pathway genes. Importantly, genetically engineered mouse models (GEMMs) have shown that manipulation of the SNPs can have profound impacts on tumourigenesis, suggesting that even these low-risk alleles could be very important in the initiation and progression of cancer. For diseases such as colon cancer, it may be that people carrying disease-associated SNPs should also undergo screening.

# Surgical oncology

Multidisciplinary approach to cancer 32

General principles 33

Diagnosis and staging 34

Curative surgery 36

Palliative surgery 38

Surgery for metastatic disease 42

Prophylactic cancer surgery 46

## Multidisciplinary approach to cancer

The management of cancer involves a number of clinical disciplines. The majority requires a variety of diagnostic tests, including some form of pathological confirmation, and imaging investigations to assess the extent of the disease. Most patients have a 1° surgical intervention. The development of more effective additional therapies for cancer, such as chemotherapy, radiotherapy, hormonal therapy, has made the overall management of cancer very complex.

No single clinician has all the skills needed to treat all cancers. This has led to the development of multidisciplinary teams (MDTs) that deal with certain types of cancer. Many professions allied to medicine have major roles to play in these teams (e.g. physiotherapists, stoma nurses, counsellors). The team may include individuals who are not directly involved in the treatment at presentation but have adjunctive roles at some stage in the course of the illness (e.g. palliative care). The composition of the team will vary considerably between institutions, and disease states. There must be a sufficient range of expertise to allow for informed discussion of the management policy for individual patients. The team's various roles include:

- planning diagnostic and staging procedures, the 1° treatment approach, and any adjuvant therapy to be delivered pre- or post-operatively
- preparing patients physically and psychologically for anti-cancer therapy and subsequent follow-up
- providing information on treatment, prognosis, side effects, and any other pertinent matters (e.g. stoma care)
- efficiently planning and delivering surgery, radiotherapy, and chemotherapy, as appropriate
- aiding rehabilitation from the illness
- providing appropriate follow-up care
- ensuring that the transition from curative to palliative care is appropriately managed
- promoting recruitment to appropriate clinical trials.

Management within such a team structure results in better outcomes for patients. Studies demonstrate survival advantages, but, equally importantly, patients also have functional, psychological, cosmetic, and quality of life (QoL) benefits.

The team should also formally audit its procedures and performance to ensure continued development of the team and to allow for comparisons with other teams.

## General principles

Surgery is the mainstay of treatment and the principal hope of cure for most patients with solid tumours. Surgery is most effective when cancer is localized, but long-term survival is now anticipated for some tumour types exhibiting metastatic disease at presentation.

Surgery has five main roles in the management of cancer patients:

- diagnosis and staging
- curative surgery
- palliative surgery
- surgery for metastatic disease
- prophylactic surgery.

An understanding of tumour biology is essential in the planning of surgical treatment for cancer and in considering if surgery is indeed appropriate.

The behaviour of solid tumours is diverse, and the implications for surgery are often paradoxical. The three principal methods of spread are:

- direct infiltration
- lymphatic
- blood-borne.

Most cancers disseminate by all three methods, to varying degrees, although one method of spread may predominate. Breast and colorectal cancers exhibit both blood and lymphatic spread, whereas cancers arising in the upper GI tract and the upper airways metastasize predominantly via the lymphatics. Even cancers arising from the same cell type behave differently—papillary and follicular tumours of the thyroid give rise to lymphatic and haematogenous metastases, respectively. Different surgical approaches will therefore be required, depending on the tumour type and behaviour.

Another important consideration is the relationship between the tumour and the host inflammatory response. There is accumulating evidence of the importance of considering such an interaction for many solid organ tumours, in terms of predicting outcome and possibly the need for adjuvant therapies.

## Diagnosis and staging

Improvements seen in radiological imaging techniques, including ultrasound, computerized tomography (CT), and MRI, have allowed for better localization and staging of malignant disease. Such developments have made it possible for radiologists to more accurately perform core biopsies or fine-needle aspiration (FNA) cytology sampling to confirm suspected diagnoses.

Endoscopic techniques are another well-utilized means of obtaining tissue (cytology, biopsy, and brushings) for histopathological analysis. Endoscopic ultrasound (EUS) now provides a further avenue for the acquisition of tissue samples for cytological or histopathological examination. The technique is also useful for cystic lesions such as those seen in the pancreas, and analysis of aspirated fluid can help to distinguish lesions with malignant potential, thus allowing their surgical treatment.

Core biopsies are often preferred and are especially useful in tumours, such as breast cancer, as they provide adequate tissue for the assessment of the architecture and receptor status.

Whilst FNA and core biopsy techniques often confirm the cancer diagnosis, it is important to bear in mind the possibility of tumour seeding. Tumour seeding is more commonly seen following core biopsy than FNA, and for specific tumour types, e.g. soft tissue sarcomas. Here, the needle track should be placed after discussion with the surgeon, so that the needle track will be excised in the definitive surgery.

In general, due to the risk of tumour seeding, transcoelomic biopsies should not be performed until discussion has occurred at an MDT appropriate to the suspected tumour type. Furthermore, they are not usually performed when a radiological diagnosis is deemed adequate, in particular, if surgical resection with cure is possible, e.g. colorectal liver metastases.

In order to reduce the risk of seeding, ablation of the track may be performed following the biopsy.

Examination of cytology samples requires an experienced cytopathologist.

The surgeon may still be required to perform either an incisional or excisional biopsy. In the former, compromise to the future definitive operation must not occur. The excisional biopsy should, in many cases, be carried out by the appropriate specialist who will be performing the definitive surgery. This applies particularly in melanoma where there is controversy over the excision margins (depending upon the depth of the melanoma). A suspicious lesion should be excised for histology with a 2mm margin.

When taking biopsies for diagnostic purposes, the surgeon needs to be in close consultation with his pathologist, as some tissue samples will need to be sent 'fresh' if specialized staining techniques, electron microscopy, or cytogenetic analyses are required. This applies in the case of lymph node excision for the subclassification of lymphoma where the tissue should always be sent fresh to the haematology laboratory.

Laparoscopy is now accepted as being an excellent tool for the diagnosis and staging of malignancy. Whilst image-directed biopsy can give a diagnosis in a large proportion of patients, some areas are not easily amenable to image-directed biopsy, and instead laparoscopic biopsy will often provide the answer. This can include tumours in the mesentery and the retroperitoneal space.

When laparoscopic evaluation is performed as part of the staging for upper abdominal malignancies, peritoneal washing cytology may be performed. A total of 500mL of warm normal saline is instilled, and the abdomen gently agitated for 5min. The fluid is then aspirated into a dedicated suction chamber and sent for cytological analysis. The detection of tumour cells is a negative prognostic indicator.

A further benefit of laparoscopic diagnosis in staging is the use of intra-operative ultrasonography via the laparoscope. This allows the detection and biopsy of masses (and staging) in solid organs such as the liver. Lesions smaller than 1cm can be identified and biopsied, and even treated by laparoscopic ablation techniques. The addition of Doppler ultrasound allows the identification of vascular structures and their avoidance (intraoperatively).

### Further reading

- Al-Haddad M, El Hajj II, Eloubeidi MA (2010). Endoscopic ultrasound for the evaluation of cystic lesions of the pancreas. *JOP* 11, 299–309.
- Lee SD, Ryu KW, Eom BW, Lee JH, Kook MC, Kim YW (2012). Prognostic significance of peritoneal washing cytology in patients with gastric cancer. *Br J Surg* 99, 397–403.
- Puli SR, Bechtold ML, Buxbaum JL, Eloubeidi MA (2013). How good is endoscopic ultrasound-guided fine-needle aspiration in diagnosing the correct etiology for a solid pancreatic mass?: A meta-analysis and systematic review. *Pancreas* 42, 20–6.

## Curative surgery

The long-term outcome following any cancer surgery depends on the combination of the tumour type and the stage at presentation. Survival rates for some cancers have improved due to earlier presentation following public awareness and screening programmes, e.g. breast and cervical cancers. Improving surgical and anaesthetic techniques mean more extensive resections can now be carried out at low risk, in terms of morbidity and mortality, often with excellent functional results, e.g. limb-preserving surgery for osteosarcoma; many liver resections today require little (or no) blood transfusion. However, this is not a uniform development, and, for tumours of the central nervous system (CNS), vital structures continue to inhibit the extent of resection.

For some cancers, results are good—the 5-year survival rate in breast cancer is over 80%, and, for large bowel cancer in the US, it approaches 70%. Unfortunately, the cure rate for pancreatic and gastric cancers remains low, with 5-year survival figures being <10% in Europe. Lung cancer patients still have an overall survival (OS) of only 15% at 5 years.

In addition to being related to tumour biology, long-term survival is also governed by the ability to obtain microscopically negative tumour margins at surgery.

- The limits of cancer clearance are extremely important, and close cooperation between the surgeon and the pathologist is essential. For example, wide local excision for breast cancer needs to have a clearance of between 0.5 and 1cm, and most patients require radiotherapy, following partial mastectomy, to prevent local recurrence. However, there is still controversy about clearance in breast cancer, with some surgeons accepting a few mm.
- Similarly, it is now recognized that, in colorectal cancer surgery, a 5cm limit proximally and a 2cm limit distally are required for adequate clearance. It is important that limits of excision are not compromised in the learning curve of laparoscopic colonic resection.
- Total mesorectal excision is essential to prevent local recurrence in the pelvis after rectal cancer. There is now clear evidence of the benefit of specialization in rectal cancer surgery.
- Cancers that are prone to multiple foci require consideration of wider resection to excise all of the tumour. This occurs, e.g. in papillary carcinoma of the thyroid gland where total thyroidectomy in some cases is appropriate. Again, this is a controversial area, with total lobectomy being accepted for good prognosis of small papillary cancers.
- There is now increasing evidence that, in major oncological surgery, the procedure should be carried out by a specialist in a unit doing a high volume of that particular procedure. The evidence is now growing that this applies to rectal, oesophageal, gastric, and pancreatic cancers.

The use of laparoscopic techniques in the definitive treatment of malignancy is evolving. Whilst there was early evidence that this approach was associated with decreased post-operative morbidity and a more rapid return to work, there were concerns regarding oncological adequacy. Long-term



follow-up in colorectal cancer has shown comparable negative margin rates, similar lymph node yields, and, most importantly, equal disease-free survival (DFS) outcomes.

Similarly, equivalence has been reported for renal, prostatic, and gynaecological cancers, and the data for gastric, oesophageal, pancreatic, and hepatic malignancies are emerging.

### Further reading

- Alexakis N, Halloran C, Raraty M, Ghaneh P, Sutton R, Neoptolemos JP (2004). Current standards of surgery for pancreatic cancer. *Br J Surg* **91**, 1410–27.
- Carpelan-Holmstrom M, Nordling S, Pukkala E, et al. (2005). Does anyone survive pancreatic ductal adenocarcinoma? *Gut* **54**, 385–7.
- Hogan AM, Kennelly R, Winter DC (2009). Volume–outcome analysis in rectal cancer. A plea for enquiring, evidence and evolution. *Eur J Surg Oncol* **35**, 111–12.
- Lo CM, Fan ST (2004). Liver transplantation for hepatocellular carcinoma. *Br J Surg* **91**, 131–3.
- Ryder S (2005). Predicting survival in early hepatocellular carcinoma. *Gut* **54**, 328–9.
- Thirlwell C, Nathan P (2008). Melanoma management. *BMJ* **337**, 1345–8.
- Thompson JF, Scolyer RA, Kefford RF (2005). Cutaneous melanoma. *Lancet* **365**, 687–701.
- Tsang WWC, Chung CC, Kwok SY, Li MKW (2005). Minimally invasive surgery for rectal cancer. *Surg Clin North Am* **85**, 61–73.
- Tsao H, Atkins MB, Sober AJ (2004). Medical progress—management of cutaneous melanoma. *N Engl J Med* **351**, 998–1012.
- Wu CC, Cheng SB, Ho WM, Chen JT, Liu TJ, P'eng FK (2005). Liver resection for hepatocellular carcinoma in patients with cirrhosis. *Br J Surg* **92**, 348–55.

## Palliative surgery

Surgical palliation falls into several different categories, requiring a broad range of expertise and knowledge. A patient's life expectancy may vary from weeks to years, depending on their underlying tumour, and the surgeon must know when not to operate and when to operate. Indeed, it is said, 'Good surgeons know how to operate, better ones when to operate, and the best when not to operate.' When an operation is indicated in the palliative setting, it is important to decide what the optimal procedure is on an individual patient basis. Discussion at a multidisciplinary meeting is therefore essential.

### Bowel obstruction

Patients with cancer may present with, or develop, obstruction of the small or large bowel.

Bowel obstruction is most commonly seen for colon cancer where obstruction of the colon may be due to a resectable 1° or an advanced pelvic mass. With the now almost universal use of CT imaging, such patients are now usually differentiated preoperatively, but occasionally confirmation of incurability will sometimes be made at the time of laparotomy. If it is not possible to excise the 1° tumour, then a colostomy or ileostomy should be considered for decompression of the obstruction. For patients with left-sided tumours, an endoscopic stent placement is an appropriate palliative measure for patients with inoperable tumours, in particular, if the patient is unsuitable for surgery due to co-morbidities. However, it must be recalled that there is a 4% risk of perforation and 12% incidence of stent migration.

The management of the obstructed ovarian cancer patient can be a more difficult decision, as some patients will be suitable for debulking surgery which may provide good long-term palliation, in particular, when combined with chemotherapy. Such operations are usually a combined approach, involving a colorectal surgeon and a gynaecologist.

Many patients will have multiple obstruction sites, with the small and large bowel studded with tumours on the serosal surface. Such patients are often difficult to palliate. Sometimes, an internal bypass is possible; a proximal stoma may be indicated, but frequently there is no surgical option.

A more detailed account of the management of obstruction is provided in Chapter 35.

### Fistulae

Fistulae may arise in one of two settings in the patient with cancer. The first is as a result of the tumour itself locally invading an adjacent organ, and the second occurs in patients who have undergone prior radiotherapy, with the majority of such fistulae being related to pelvic tumours.

Common fistula types include: rectovaginal, enterovaginal, colovesical, and vesicovaginal. Fistulae may also develop between loops of bowel (enteroenteric) or between the bowel and skin (enterocutaneous).

Preoperative assessment is important to determine the exact nature of the fistula present, including its origin and course. In the palliative setting, a proximal end stoma is the treatment of choice if definitive surgery is not possible, as it should reduce the volume, and hence patient distress, associated with the stoma. A covered stent, delivered endoscopically, can be considered for patients with a colovesical fistula.

## Jaundice

A number of options are available for the patient requiring palliation of jaundice. Currently, the majority of patients are considered for stenting which is accomplished by means of endoscopic retrograde cholangio-pancreatography (ERCP) for lesions of the periampullary region. For cholangiocarcinomas arising at the hilum, ERCP may be successful, but percutaneous transhepatic cholangiography (PTC)-guided stenting may be required, sometimes in combination with ERCP. Metallic stents are preferred if the predicted survival is in excess of 3 months, as plastic stents rapidly block, leading to recurrent jaundice and cholangitis, requiring repeated hospitalization.

There are also operative options, including hepatojejunostomy or choledochojejunostomy, for the palliation of periampullary tumours, as these procedures offer good palliation in medically fit patients. With the advent of endoscopic stenting, operative palliation of jaundice fell out of vogue; however, they are now being performed laparoscopically in many specialist centres. A recent trial has demonstrated a shorter overall hospital stay and decreased morbidity for the surgical palliation of jaundice, compared to endoscopic stenting. Selected patients with inoperable hilar tumours will be best treated by segment III biliary enteric bypass, and so all such patients should be discussed in a hepato-pancreato-biliary (HPB) MDT.

A more detailed account of the management of obstructive jaundice is provided in Chapter 35.

## Ascites

The treatment of malignant ascites includes sodium restriction, diuresis, and serial paracentesis—the typical treatments used in hepatic failure-associated ascites. For selected cases refractory to conventional medical treatment, a peritoneal drain may be utilized, or a peritoneal–venous (Le Veen or Denver) shunt may be inserted to relieve symptoms. These may be of particular benefit for those with ascites due to ovarian or breast cancer but appear to be of little benefit in those with GI malignancies. Careful preoperative assessment should be undertaken to ensure that the ascites is not loculated and that the tumour is not mucinous; otherwise, the shunt will occlude rapidly. The shunts are usually inserted under local anaesthetic and sedation, with >50% of patients achieving good long-term palliation. Post-operative coagulopathy may be a problem, as are shunt occlusion and infection.

## Pain

The management of pain in the patient with cancer may be difficult and requires careful liaison with the palliative care team and Macmillan nurses.

There are a number of options open to surgeons to help patients with pain, depending on the aetiology:

- surgical debulking of large, slow-growing tumours (e.g. intra-abdominal, soft tissue sarcomas) is possible in otherwise fit patients where the expected morbidity of the procedure is deemed acceptable
- stabilization of pathological fractures and prophylactic pinning of bone metastases involving >50% of the cortex
- neurosurgical approaches for pain control, including cordotomy, are now rarely performed with the advent of more effective analgesia regimens

- thoracoscopic splanchnectomy was used for intractable pain 2° to pancreatic cancer. However, the advent of EUS-guided coeliac plexus blocks has reduced its utilization.

### **Gastrointestinal bleeding**

For patients in whom haemostatic manipulation fails to control bleeding, a wide array of endoscopic and radiological techniques are available to stop bleeding from benign and malignant causes in incurable cancer patients, including injection sclerotherapy and laser coagulation, and arteriographic embolization. Surgery should be reserved for those with a life expectancy of 3 months or more, for whom other methods fail.

### **Cytoreductive surgery**

In some patients, extensive local disease may prevent the removal of all disease by surgery, but partial resection is still appropriate. This applies particularly to ovarian cancer where subsequent chemotherapy can lead to good results, even in advanced disease.

### **Palliative resection of the primary tumour**

Up to 10% of patients with breast cancer will present with metastatic disease; patients with visceral metastases have a poor prognosis, but patients with bone metastases have a median survival of over 2 years. Resection of the 1° tumour to achieve loco-regional control will often improve patients' QoL, preventing fungation or uncontrolled axillary metastases.

Palliative resection of gastric cancers may be considered in patients with gastric outlet obstruction or persisting anaemia despite repeat transfusion. Likewise, resection of a colorectal 1° may be considered, even in the presence of inoperable liver metastases, to minimize the risk of bleeding, perforation, or obstruction (especially the latter).

Developments in laparoscopic surgery have meant that many palliative procedures can now be performed using minimally invasive techniques, thus reducing morbidity and improving the QoL.

### **Further reading**

- Avantumde AA, Parsons SL (2007). Pattern and prognostic factors in patients with malignant ascites: a retrospective study. *Ann Oncol* **18**, 945–9.
- Baron TH (2001). Expandable metal stents for the treatment of cancerous obstruction of the gastrointestinal tract. *N Engl J Med* **344**, 1681–7.
- Chao TC, Wang CS, Chen MF (1999). Gastroduodenal perforation in cancer patients. *Hepatogastroenterology* **46**, 2878–81.
- Helyer LK, Law CH, Butler M, Last LD, Smith AJ, Wright FC (2007). Surgery as a bridge to palliative chemotherapy in patients with malignant bowel obstruction from colorectal cancer. *Ann Surg Oncol* **14**, 1264–71.
- Hill J (2008). Stenting and colorectal cancer. *Br J Surg* **95**, 1195–6.
- Mittal A, Windsor J, Woodfield J, Casey P, Lane M (2004). Matched study of three methods for palliation of malignant pyloroduodenal obstruction. *Br J Surg* **91**, 205–9.
- Randall TC, Rubin SC (2000). Management of intestinal obstruction in the patient with ovarian cancer. *Oncology* **14**, 1159–63.
- Rose PG, Nerenstone S, Brady MF (2004). Secondary surgical cytoreduction for advanced ovarian carcinoma. *N Engl J Med* **351**, 2489–97.
- Sangisetty SL, Miner TJ (2012). Malignant ascites: a review of prognostic factors, pathophysiology and therapeutic measures. *World J Gastrointest Surg* **4**, 87–95.
- Zanon C, Grosso M, Apra F, et al. (2002). Palliative treatment of malignant refractory ascites by positioning of Denver peritoneovenous shunt. *Tumori* **88**, 123–7.



## Surgery for metastatic disease

In principle, patients with a single site of metastatic disease and the occasional patient with multiple sites of metastases may be considered as candidates for resection. The 1° location of the tumour and the location of the metastatic disease are key in making such decisions. Sites where limited metastases may be resected include the lung, liver, and brain, with prolonged survival seen in carefully selected patients, following careful assessment and discussion at an MDT.

### Lymphatic clearance

- May be curative for some cancers.
- May avoid the need for adjuvant chemotherapy or radiotherapy (avoids the need for axillary radiotherapy in breast cancer).
- Useful in:
  - breast cancer
  - colorectal cancer
  - head and neck cancer
  - penile cancer.
- No role for prophylactic nodal dissection has been seen for melanoma.
- There is a role for sentinel node dissection in breast cancer and melanoma. In the UK, the ALMANAC (2004) trial showed benefit in breast cancer. Virtually all breast surgeons now perform sentinel node surgery in the UK and US.

### Liver metastases

- Metastases to the liver are blood-borne and usually through the portal venous system.
- Most metachronous liver metastases are incidental findings on post-operative surveillance CT scans. Further assessment of the liver may include MRI, and CT-positron emission tomography (CT-PET) is useful in excluding extra-hepatic metastases.
- Greatest experience is with 2° arising from colorectal 1°.
- There are no randomized trial data to support liver resection; however, the mean survival of untreated patients is 16 months, whereas the 5-year survival for selected patients is ~50% in contemporary series (colonic 2°), with a <1% operative mortality but 30% morbidity.
- The use of neoadjuvant chemotherapy regimens has increased resectability rates by downsizing metastases and also improved post-resection survival.
- A good idea of prognosis is provided by the Fong score, in which a point is given for each adverse factor: size >5cm; node-positive 1°; >1 tumour; disease-free interval <12 months; CEA >200ng/mL. The median survival varied from 74 months for a score of 0 to 22 months for a score of 5.
- Repeated liver resection is possible (including repeated laparoscopic resection), with results of further resection as good as the first if the same selection criteria are applied.
- Staged resection is also possible, with hypertrophy of the remnant liver encouraged by portal vein embolization.
- The benefit of liver resection for non-colorectal cancer is variable.
- Liver resection for neuroendocrine liver metastases gives a 5-year survival of up to 50%.

- Up to 60% 5-year survival has been reported for the resection of liver 2° from the genitourinary tract (including testis, ovary, kidney, uterus).
- Resection of liver 2° from other 1° sites is unproven, with only limited or no benefit for breast and melanoma 2° in highly selected patients.
- Laparoscopic liver resection is now increasingly used, and, together with enhanced recovery programmes, post-operative stay and time to return to normal activities are reduced.

#### *Other treatment options*

- Radiofrequency ablation (RFA) is now increasingly used in the treatment of metastatic disease in the liver in selected patients.
- Microwave ablation is a more recent development and may have advantages over RFA.
- Injection of alcohol and cryotherapy are now less frequently utilized, in particular, for liver metastases, although they are still used for HCC.

### **Lung metastases**

- Spread to the lung is via lymphatics or blood-borne.
- The lung is the second commonest site for metastases. In one-fifth of patients, the lung is the sole site of metastases.
- As is the case with liver metastases, the majority of lung 2° are incidental findings on post-operative surveillance CT scans. Again, CT-PET is useful in excluding extra-thoracic disease.
- Criteria for lung resection include: 1° tumour controlled, a medically fit patient, and metastatic disease limited to the lung—although some centres are now accepting patients with lung and liver metastases from colorectal 1° for sequential resections.
- Metastasectomy can be performed with low morbidity and mortality, and repeatedly.
- Thoracoscopic techniques are now commonplace.
- The 5-year survival after resection of lung metastases varies according to the 1° lesion: osteosarcoma (40%); soft tissue sarcoma (25–40%); colorectal (35%); renal (40%); gynaecological (35%); melanoma (20%); germ cell tumours (86%).

### **Bone metastases**

- Presentation is usually that of a pathological fracture.
- The breast and prostate are the commonest 1° sites, followed by the lung, thyroid, and renal cancers.
- Mean survival is 3 months with lung cancer metastases to over 4 years in 1° of breast origin.
- Investigations—MRI and CT-PET are the most accurate investigations, followed by bone scanning.
- Internal fixation is useful if the metastasis is:
  - in a weight-bearing bone, especially if the lesion is >2.5cm or involves the circumference
  - lesion is painful after radiotherapy
  - will improve mobilization and nursing care
  - bone quality will support fixation.
- In the case of a spinal metastasis, consideration must be given to stabilizing the spine and preventing cord compression.

**Treatment options**

- Stabilization may be accomplished in one of two ways:
  - Internal fixation—techniques include plates, intramedullary nails, or prosthetic replacement of metaphyseal lesions.
  - External fixation—occasionally external fixation is used for patients with extensive localized disease that cannot be immobilized by internal methods.
- Rarely, amputation is appropriate for fungating tumours, recurrent infections, and intractable pain.
- Minimally invasive treatment of metastatic bone lesions with radiographically guided percutaneous injection of bone cement is currently used in selected cases such as spinal metastases.

**Brain metastases**

- Common—up to 10% of cancer patients have brain 2°.
- The 5-year cumulative incidence of brain metastases is 16%, 10%, 7%, 5%, and 1% for patients with lung cancer, renal cell cancer, melanoma, breast cancer, and colorectal cancer, respectively. The lung and breast are the commonest 1° sites.
- Brain metastases are blood-borne with the distribution of brain metastases reflecting blood flow—80% of lesions are found in the cerebrum, 15% in the cerebellum, and 5% in the brainstem.
- Presentations include headache, focal weakness, altered mental status, and epilepsy.
- Haemorrhage within brain metastases may cause an acute neurological state.
- Diagnosis is by MRI, as this identifies smaller 2° than CT.
- Mean survival without therapy is 2 months, 3 months with steroid therapy, and 6 months with radiotherapy.
- Surgery is useful to confirm diagnosis, relieve pressure effects, improve local control, and improve survival in selected cases.
- Poor prognostic indicators include—uncontrolled systemic disease, poor general medical condition, infra-tentorial location, poor neurological status, and a short interval from the diagnosis of the 1° tumour to the diagnosis of the brain metastases.
- Tumour deposits in the thalamus, brainstem, and basal ganglia are usually irresectable.
- Resection of a single 2° can lead to prolonged survival (melanoma 7 months, lung cancer 12 months, renal cell cancer 10 months, breast cancer 1 year, and colon cancer 9 months). Occasionally, resection of multiple metastases is worthwhile.

**Malignant pleural effusion**

- Surgery is rarely indicated, as this can usually be managed medically.
- Occasional role for thoracoscopy to drain fluid, break down adhesions, biopsy the pleura, and instill sclerosing agents such as talc or bleomycin.
- Rarely, pleurectomy is performed in malignant mesothelioma, but there is significant morbidity and the mortality is 10%. The procedure can only be performed in very selected patients (for further information, see Chapter 13).



## Malignant pericardial effusion

In selected patients, the creation of a pericardial window compares favourably with pericardial percutaneous drainage.

### Further reading

- Abu Hilal M, McPhail MJW, Zeidan B, et al. (2008). Laparoscopic versus open left lateral hepatic sectionectomy. *Eur J Surg Oncol* **34**, 1285–8.
- Assal M, Zanone X, Peter A (2000). Osteosynthesis of metastatic lesions of the proximal femur with a solid femoral nail and interlocking spinal plate inserted without reaming. *J Orthop Trauma* **14**, 394–7.
- Barry JM, Weber WP, Sacchini V (2012). The evolving role of axillary lymph node dissection in the modern era of breast cancer management. *Surg Oncol* **21**, 143–5.
- Cheung G, Chow E, Holden L (2006). Percutaneous vertebroplasty in patients with intractable pain from osteoporotic or metastatic fractures. *Can Assoc Rad J* **57**, 13–21.
- Erhunmwunsee L, D'Amico TA (2009). Surgical management of pulmonary metastases. *Ann Thorac Surg* **88**, 2052–60.
- Folprecht G, Gruenberger T, Bechstein WO, et al. (2010). Tumour response and secondary resectability of colorectal liver metastases following neoadjuvant chemotherapy with cetuximab: the CELIM randomised phase 2 trial. *Lancet Oncol* **11**, 38–47.
- Fong Y, Fortner J, Sun RL, Brennan MF, Blumgart LH (1999). Clinical score for predicting recurrence after hepatic resection for metastatic colorectal cancer: analysis of 1001 consecutive cases. *Ann Surg* **230**, 309–18.
- Fuchs B, Ossendorf D, Leerapun T, Sim FH (2008). Intercalary segmental reconstruction after bone tumour resection. *Eur J Surg Oncol* **34**, 1271–6.
- Inoue M, Kotake Y, Nakagawa K, Fujiwara K, Fukuhara K, Yasumitsu T (2000). Surgery for pulmonary metastases from colorectal carcinoma. *Ann Thorac Surg* **70**, 380–3.
- Kaibara N, Sumi K, Yonakawa M, et al. (1990). Does extensive dissection of lymph nodes improve the result of surgical treatment of gastric cancer? *Am J Surg* **159**, 218–21.
- Ko AS, Lefor AT (2005). Laparoscopic surgery in cancer. In: Devita VT, Hellman S, Rosenberg SA, eds. Principles and practice of oncology, 7th edn. Philadelphia: Lippincott, pp. 253–66.
- Lehmann K, Rickenbacher A, Weber A, Pestalozzi BC, Clavien PA (2012). Chemotherapy before liver resection of colorectal metastases: friend or foe? *Ann Surg* **255**, 237–47.
- Pathak S, Jones R, Tang JM, et al. (2011). Ablative therapies for colorectal liver metastases: a systematic review. *Colorectal Dis* **13**, e252–65.
- Prasad D, Schiff D (2005). Malignant spinal cord compression. *Lancet Oncol* **6**, 15–24.
- Sciubba DM, Gokaslan ZL, Suk I, et al. (2007). Positive and negative prognostic variables for patients undergoing open surgery for metastatic breast disease. *Eur Spine J* **16**, 1659–67.
- Thompson JF, Scolyer RA, Kefford RF (2005). Cutaneous melanoma. *Lancet* **365**, 687–701.
- Vogelsang H, Haas S, Hierholzer C, Berger U, Siewert JR, Präuer H (2005). Factors influencing survival after resection of pulmonary metastases from colorectal cancer. *Br J Surg* **91**, 1066–71.
- Wilkinson AN, Viola R, Brandegee MD (2008). Managing skeletal related events resulting from bone metastases. *BMJ* **337**, 1101–5.
- Wong SL, Balch CM, Hurley P, et al. (2012). American Society of Clinical Oncology; Society of Surgical Oncology. Sentinel lymph node biopsy for melanoma: American Society of Clinical Oncology and Society of Surgical Oncology joint clinical practice guideline. *J Clin Oncol* **30**, 2912–18.
- Yim AP, Ho JK (1995). Video assisted subxiphoid pericardiectomy. *J Laparoendosc Surg* **5**, 193–8.

## Prophylactic cancer surgery

Surgery has a very definite role in the prevention of cancer in selected patients. There are a number of conditions, either acquired or inherited, in which preventative surgery has a major role after careful counselling of the patient. These include:

- orchidopexy or occasionally orchidectomy in the patient with a maldescended testis
- total colectomy with pouch procedure, in patients with polyposis coli
- the occasional patient with ulcerative colitis involving the entire colon (over 10 years) and who has changes of dysplasia on mucosal biopsies may require a total colectomy
- patients at risk of medullary cell carcinoma of the thyroid gland, who have the multiple endocrine neoplasia (MEN) syndrome (type 2), require total thyroidectomy at an early age
- patients carrying the *BRCA1* gene may require prophylactic bilateral mastectomy (and reconstruction). With the recent approval of National Institute for Health and Care Excellence (NICE) (2013) of tamoxifen as a prophylactic drug in these patients with the *BRCA1* and 2 mutations, there may be fewer patients requesting prophylactic breast surgery—this remains to be seen. Similarly, patients with familial ovarian cancer may require a laparoscopic oophorectomy.

The role of prophylactic cancer surgery is discussed further in Chapter 11.

### Further reading

- Depue RH, Pike MC, Henderson BE (1986). Cryptorchidism and testicular cancer. *J Natl Cancer Inst* 77, 830–3.
- Galmiche JP, Pallone F (2005). Barrett's oesophagus and oesophageal adenocarcinoma. *Gut* 54 (Suppl 1), i1–i42.
- Lynch HT (1996). Is there a role for prophylactic subtotal colectomy among hereditary non-polyposis colorectal cancer germ line mutation carriers? *Dis Colon Rectum* 39, 109–10.
- Lynch HT, De la Chapelle A (2003). Hereditary colorectal cancer. *N Engl J Med* 348, 919–32.
- Machens A, Niccoli-Sire P, Hoel J, et al. (2003). Early malignant progression of hereditary medullary thyroid cancer. *N Engl J Med* 349, 1517–25.

## Part 2

# Principles of treatment

4	Principles of radiation oncology	49
5	Principles of chemotherapy	83
6	Principles of symptom control in palliative care	111
7	Late effects of chemotherapy and radiotherapy	157
8	Hormone therapy	169
9	Targeted and biological therapies	179



# Principles of radiation oncology

Introduction	50
Radiobiology of normal tissues	52
Radiotherapy fractionation	56
External beam radiotherapy	60
Progress in external beam radiotherapy	64
Recent advances in external beam radiotherapy	66
Electron beam therapy	68
Brachytherapy	70
Intraoperative radiotherapy	74
The role of unsealed radionuclides	76
Total body irradiation	80

## Introduction

Radiation oncology or radiotherapy is the treatment of malignant disease with ionizing radiation, most commonly using high-energy X-ray beams, external beam radiotherapy (EBRT). This treatment modality has been developed over the last 100 years, with considerable technical and clinical advances. It is now arguably the most important non-surgical cancer therapy, used in >50% of all patients with malignant disease.

### Historical perspective

1896	Discovery of X-rays
1898	Discovery of radium
1899	Successful treatment of skin cancer with X-rays
1915	Treatment of cervical cancer with radium implant
1922	Cure of laryngeal cancer with a course of X-ray therapy
1928	Roentgen defined as the unit of radiation exposure
1934	Dose fractionation principles proposed
1950s	Radioactive cobalt teletherapy (1MV energy)
1960s	Production of megavoltage X-rays by linear accelerators
1990s	Three-dimensional (3D) radiotherapy planning
2000s	Intensity-modulated (IMRT), image-guided (IGRT), and stereotactic radiotherapy

When X-rays pass through living tissue, energy is absorbed, resulting in the ionization of a number of molecules, with the generation of fast-moving electrons and free radicals. Biologically, the most important effects involve DNA where radiation may cause damage, including breaks in the DNA double helix.

The SI unit for dose of radiation is the gray (Gy), the energy absorbed per unit mass (J/kg).

The biological effects of radiotherapy relate to both the dose of radiation and the timing of delivery of this treatment. Early clinical experience with radiotherapy demonstrated that the delivery of small daily doses or fractions of radiotherapy allowed the administration of a larger total dose of radiation than could be safely given as a single fraction, with preferential reduction in normal tissue damage, whilst maintaining cell kill in malignant tissue. This provides the basis of fractionated radiotherapy in modern radiation oncology, in which the majority of treatments are delivered using small daily doses over consecutive days/weeks.

Fractionation is the division of a total dose of EBRT into small, often once-daily doses. It results in preferential sparing of normal tissue damage, allowing safe delivery of higher total doses of radiation, with increased cancer cell kill.



## Radiobiology of normal tissues

The effects of radiation on tissues are generally mediated by one of two mechanisms:

- loss of mature functional cells by apoptosis (programmed cell death, usually within 24h of irradiation)
- loss of cellular reproductive capacity.

In general, these effects are dose-dependent; increasing doses of radiation produce greater cell loss. However, different cell types show large differences in radiosensitivity to either of these processes (see Table 4.1). A limited number of cell types predominantly respond by apoptosis. These include some cells of haemopoietic lineage and salivary glands. As most tissues or organs have redundant functional cells, they may lose a significant fraction of this cell population by apoptosis, without clinical impairment of tissue function. Usually, lost cells are replaced by proliferation of surviving stem cells or progenitor cells. These may be cells surviving in irradiated tissue or cells migrating from unirradiated margins.

**Table 4.1** Radiosensitivity of normal tissues

Radiosensitivity	Tissue
Highly sensitive	Lymphocytes, germ cells
Moderately sensitive	Epithelial cells
Resistant	CNS, connective tissue

When cell loss occurs predominantly through loss of proliferative capacity, the rate of cell renewal of a particular organ determines the time of appearance of tissue damage, varying from days to even years, after irradiation. This has led to the arbitrary distinction of acute and late effects of radiation, with acute effects being restricted to changes developing during a course of radiotherapy of up to 8wk.

### Acute effects of radiation

Acute effects involve mainly the skin, mucosa, and haemopoietic system. Although the initial cell loss may be partly through apoptosis, the predominant effect is loss of reproductive capacity, interfering with the replacement of lost cells. Thus, tissues with fast normal cellular turnover (epithelia of the skin and gut, bone marrow) display effects of irradiation earliest.

The timing of radiation effects also depends on the rate of dose administration or fractionation. After a single dose of 10Gy to the abdomen, the mucosal lining of the intestinal tract is depleted in a few days, whilst it may take several weeks during a fractionated course of radiotherapy with daily doses of 2Gy.

The speed of recovery of an acute reaction depends on the level of stem cell depletion and varies from a few days to several months. If the number of surviving stem cells is too low, severe epithelial damage may persist as a chronic ulcer.



### Acute effects of radiotherapy

- Occur within 8wk of treatment
- Skin, GI tract, bone marrow
- Severity depends on total dose of radiation and length of time over which radiotherapy delivered
- Treatment doses selected, so that complete recovery is usual

### Late effects of radiotherapy

Late effects occur predominantly in slowly proliferating tissues (such as the lung, kidney, heart, liver, and CNS) but are not restricted to these slowly renewing cell systems. For example, in the skin, in addition to the acute epidermal reactions, late changes can develop several years later.

By definition, late radiation reactions are not apparent until a considerable time after irradiation, and these are not always predicted by the severity of the acute reaction. Although the total dose of radiation is most important, another major determinant of the late radiation effect is the dose of radiation per fraction of treatment.

### Late effects of radiotherapy

- Lung, kidney, CNS, heart, connective tissue
- Severity depends on total dose of radiation and dose per fraction (small dose per fraction protects)
- Recovery may be incomplete

The distinction between acute and late effects has important clinical implications. Since acute reactions are observed during the course of a conventionally fractionated radiotherapy schedule (~2Gy per fraction, five times a week), it is possible to reduce the total dose in the event of unexpectedly severe reactions, allowing a sufficient number of stem cells to survive. Surviving stem cells will repopulate and restore the integrity of the rapidly proliferating tissue, preventing irreparable damage.

If the overall treatment time is reduced, e.g. by the use of dose fractions of >2Gy, the acute reactions may not reach maximal intensity until after completion of treatment. This precludes adjustment of the dose regimen to the severity of reactions. If intensive fractionation schedules reduce the number of surviving stem cells to below the level needed for effective tissue restoration, acute reactions may persist as chronic injury.

### Radiation effects in specific tissues

#### *Skin: acute effects*

- Erythema 'sunburn' reaction:
  - starting wk 2–3
  - skin feels hot, itchy, sore.
- Desquamation:
  - initially dry peeling of epidermis
  - later moist and painful, with exposure of dermis
  - usually heals within 6wk of treatment completion; residual pigmentation fades over months.
- Ulceration only if above reaction fails to heal.

*Skin: late effects (months/years)*

- Atrophy.
- Fibrosis.
- Telangiectasia.

*Oral mucosa*

- Erythema starting wk 2–3.
- Painful ulceration wk 4–6.
- Usually healed 4wk post-radiotherapy.
- Dry mouth may persist as late effect, depending on volume of salivary glands irradiated and dose.

*Gastrointestinal tract*

- Acute mucositis causes site-specific effects, starting wk 1–4.
- Oesophagitis.
- Gastric/small bowel—5-hydroxytryptamine (5-HT<sub>3</sub>)-mediated nausea and vomiting.
- Distal small bowel/colon—diarrhoea.
- Rectum—tenesmus, mucous discharge, bleeding.
- Late effects—mucosal ulceration, fibrosis/obstruction, necrosis.

*Central nervous system*

- No acute reaction.
- 2–6 months—demyelination effects:
  - brain—somnolence
  - spinal cord—Lhermitte's syndrome (shooting pains radiating down limbs below the level of injury, sometimes provoked by spinal flexion).
- 1–2 years—radiation necrosis (irreversible neurological deficit).

*Lung*

- Acute deterioration of airways obstruction after large (e.g. 8Gy) single fractions.
- 2–6 months—radiation pneumonitis:
  - cough, dyspnoea, reversible X-ray changes
  - may improve with steroid therapy.
- 6–12 months—irreversible lung fibrosis.

*Kidney*

- No acute response.
- Large reserve capacity; effects occur up to 10 years post-radiotherapy.
- Radiation nephropathy:
  - proteinuria
  - hypertension
  - renal failure.

*Heart*

- 6–24 months—pericarditis (self-limiting).
- >2 years—cardiomyopathy and conduction blocks.

## Normal tissue tolerance to retreatment

Previously, it was believed that the late effects of radiotherapy were irreversible and treatment of an area of the body that had previously been irradiated to high dose carried a risk of serious morbidity. Recent studies have shown that some tissues and organs have a substantial ability to recover from subclinical radiation injury, allowing the retreatment of previously irradiated sites. The large capacity of the CNS for long-term regeneration allows the safe retreatment of parts of the brain or the spinal cord and offers new clinical possibilities for tumours recurring in or near these critical structures.

## Carcinogenesis

DNA damage caused by radiotherapy may cause the development of a new cancer. A 2° malignancy may occur 5–30 years after radiation exposure. Leukaemias occur most frequently at 6–8 years after radiotherapy. Solid cancers may occur after 10–30 years, and certain organs, such as the thyroid and breast, are particularly susceptible to developing 2° cancer, especially when exposure to radiation occurs in childhood/young adulthood.

- Induction of a second cancer is a rare, but serious, consequence of exposure to ionizing radiation, often with a long latent period
- For oncology patients, such risks must always be weighed against the risk of recurrence of cancer

## Repair of radiation-induced DNA damage

Some of the DNA lesions caused by radiation can be repaired. When >1 fraction of radiotherapy is delivered daily, a minimum gap of 6–8h between fractions is required to allow repair, without which excessive normal tissue damage occurs. A number of rare hereditary defects in DNA repair exist, and some of these predispose to cancer (e.g. ataxia–telangiectasia). The use of conventional doses of radiotherapy to treat these cancers may result in severe normal tissue reactions.

## Hypoxia

Hypoxic cells are 2–3 times less sensitive to radiotherapy than oxygenated cells, and, in many cancers, there are areas of hypoxia relating to the abnormal blood supply of the cancer. Anaemia may aggravate this. During a fractionated course of radiotherapy, response of the cancer to treatment may result in reoxygenation of areas of initial hypoxia, further enhancing the tumour cell kill.

## Radiotherapy fractionation

### Objective

To choose, for a course of EBRT, the most appropriate combination of:

- total dose of radiotherapy (Gy) to achieve the required effect on the cancer
- number of doses or fractions
- overall treatment time (determined by number of fractions per week).

### Linear quadratic model

At clinically relevant doses, cancers and early-reacting tissues respond to ionizing radiation with a linear relationship between the dose and cell kill—the linear or  $\alpha$  component. In the late-reacting tissues, a large part of the effect of radiation is related to the square of the individual dose given—the quadratic element or  $\beta$  component.

The important implication of the linear quadratic model is that, by giving radiotherapy in many small doses, damage in the late-reacting tissues should be minimized, with little or no alteration in the response of the early-reacting normal tissues and, most importantly, the cancer.

### Number of treatments

Traditionally, radiotherapy has been delivered once daily, Monday to Friday, and two different fractionation schedules are widely used.

#### *Few large daily fractions*

- Advantages:
  - fewer attendances
  - sparing of resources
  - fast tumour response
  - reduces risk of tumour repopulation during treatment course.
- Disadvantages:
  - limits total dose that can be safely delivered
  - increases risk of late normal tissue damage
  - reduced potential for reoxygenation
  - total dose is usually inadequate to eradicate all cancer cells in target.

#### *Many small daily fractions*

- Advantages:
  - less severe acute reactions (longer treatment time)
  - reduced late normal tissue damage
  - maximizes total dose that can be delivered
  - maximizes reoxygenation
  - total dose may be sufficient to eradicate all cancer cells
  - total dose may be reduced if unexpectedly severe acute reaction.
- Disadvantages:
  - demand on resources and patient
  - potential for repopulation of fast-growing tumours during radiotherapy
  - prolonged acute reaction may need supportive treatment, e.g. dietary support for sore mouth/oesophagitis.

### Radiosensitivity of tumours

Some tumours, such as lymphoma and seminoma, may be controlled by doses (20–35Gy) ~ half of that required for many carcinomas (60–70Gy); others, including gliomas and sarcomas, may be resistant to the highest doses that can be safely delivered.

### Tolerance doses of normal tissues

Some tissues are particularly radiosensitive and doses to them must be limited in order to minimize the risk of late damage. If 2Gy per fraction is given, then tolerance doses are:

- Testis 2Gy
- Lens of the eye 10Gy
- Whole kidney 20Gy
- Whole lung 20Gy
- Spinal cord 50Gy
- Brain 60Gy

The risk of significant late and irreparable damage rises acutely above these levels.

### The inter-fraction interval

After a radiation treatment, some of the damage induced is irreversible, but some can be repaired. With once-daily fractionation, nearly all of the repair process is complete, before the next treatment is given. If >1 treatment is given during a day, the duration of time between fractions should be at least 6h to allow as much repair as possible in normal tissues.

### Hyperfractionation

By giving many fractions of <2Gy, a higher total radiation dose may be delivered without an increase in late normal tissue damage. In order to avoid increasing the total time for the treatment course, treatment may be given at weekends or more than once daily.

### Overall treatment time and accelerated radiotherapy

There is now evidence that some cancers (e.g. lung cancer) have the capacity for rapid proliferation, with significant potential for growth during a conventional 6wk course of radiotherapy. By shortening the overall duration of a treatment course, the opportunity for this to occur is reduced. This approach may be combined with hyperfractionation by treating 2–3 times daily to minimize late normal tissue damage.

In a randomized controlled trial, the CHART regimen (Continuous Hyperfractionated Accelerated RadioTherapy), in which 54Gy is given in 1.5Gy fractions three times on each of 12 consecutive days, proved superior to conventional radiotherapy (60Gy in 30 fractions in 6wk) in non-small-cell lung cancer (NSCLC) without any increase in late normal tissue damage.

### The optimum fractionation regimen

The clinical circumstances dominate the choice of regimen for each individual patient. Treatment is broadly divided by intention, either curative or palliative.

#### *Radical radiotherapy*

- The highest tolerable dose is usually given to maximize probability of eradication of cancer.
- Lower doses for highly radiosensitive malignancies and to eradicate microscopic residual disease of moderate radiosensitivity, e.g. adjuvant therapy post-surgery.
- Multiple daily fractions of around 2Gy employed to minimize the risk of late radiation damage.
- Considerable acute toxicity acceptable because of anticipated survival benefit.
- Patients must be fit enough for daily attendance over several weeks.

#### *Palliative radiotherapy*

- Aim is to achieve quick symptom relief.
- May have little or no impact on survival time.
- Prefer the lowest dose and the number of fractions that will achieve the desired response.
- Avoid prolonged acute normal tissue damage.
- Late normal tissue effects may be irrelevant.
- High-dose palliative radiotherapy may be appropriate in patients with disease too advanced for radical treatment, where durable local disease control is the aim, in tumours which have not disseminated widely, and where life expectancy is at least many months.



## External beam radiotherapy

### Basic principles

Treatment with beams of ionizing radiation produced from a source external to the patient is known as EBRT.

#### *Superficial X-ray therapy*

Superficial tumours (e.g. skin, ribs) may be treated with X-rays of low energy, in the range of 80–300kV. Electrons, emitted from a heated cathode, are accelerated across an X-ray tube, strike a tungsten anode, and undergo bremsstrahlung interactions to produce X-rays. The beam size is selected by using metal applicators of different sizes.

#### *Cobalt teletherapy*

Deeper-seated tumours are usually treated using megavoltage photons. One option is to use a source of cobalt Co-60, emitting  $\gamma$  rays of average energy of 1.25MeV. Source strengths of about 350TBq are required to achieve a sufficiently high-dose rate.

#### *Megavoltage radiotherapy*

However, much more commonly, megavoltage X-rays are produced by linear accelerators, in which electrons are accelerated to near the speed of light in a waveguide, before striking a thin transmission target. The resultant X-rays can have energies in the range of 4–20MV. Such beams offer advantages of higher penetration, higher dose rate, and better collimation (restriction of the radiation to the treatment field) than beams of Co-60.

#### *Electron therapy*

Some linear accelerators are also configured to produce beams of electrons of various energies, usually in the range of 4–20MeV. Such beams can uniformly treat from the skin surface down to a specified depth (related to the energy), with a fairly rapid fall-off in dose beyond that. For example, 6MeV electrons will treat down to about 1.5cm deep, and 20MeV to about 5.5cm. Electrons offer a good alternative to kilovoltage X-rays for treating superficial tumours.

The main limitations of low-energy X-ray beams are:

- unsuitability for the treatment of deep-seated malignancies, e.g. thorax, abdomen, pelvis
- inherent delivery of high dose to the skin
- relatively rapid 'fall-off' of dose with depth
- higher absorbed dose in bone, compared with soft tissue



### Features of megavoltage X-rays

- High dose delivered at depth through tissue
- Maximum dose below skin surface
- Skin sparing
- Absorbed dose falls off exponentially with depth in tissue
- Sharp 'fall-off' of dose at beam edge (penumbra)
- Beam shape can be modified by metal blocks or multileaf collimators, now an integral part of modern linear accelerators
- Metal filters or wedges can be used to create a gradient in the dose across the beam
- Treatment from any direction is feasible
- Crossfire technique with 2–4 beams gives higher target dose and relative sparing of adjacent normal tissues

### The planning process

There are six major steps in designing and delivering EBRT treatment.

#### *Step 1. Beam dosimetry*

The pattern of dose distribution from each linear accelerator has to be measured prior to clinical use (see Fig. 4.1). Due to absorption properties at such high energies, these measurements can be made using a small ionization chamber dosimeter in a tank of water. It is also essential to measure calibration factors (known as output factors) that define the irradiation time required for a specified absorbed dose for each treatment machine.

#### *Step 2. Planning computer*

Simple planning can be carried out using tables or plots of measured beam data. However, most planning is performed using computers with specialized application software. Calculations are based on measured beam data but also depend on algorithms that allow for varying attenuation and scatter of X-rays in tissues of different densities. This density information is often based on CT scans performed with the patient in the treatment position.

#### *Step 3. Target drawing*

The most important step in planning radiotherapy is defining the target, i.e. the volume of tissue to be irradiated. This includes the gross tumour volume (GTV) (e.g. as visualized clinically or on CT scan), together with surrounding tissues that might have microscopic invasion of tumour cells (clinical target volume, CTV). A further margin has to be allowed for uncertainties in the treatment set-up; these include variations in patient positioning, internal organ movement, and tolerances of machine calibration (planning target volume, PTV). It is also essential to define the position of critical organs, i.e. those with a lower tolerance to radiation such as the spinal cord, eyes, and kidneys. All can be drawn directly into the planning computer on a set of CT images covering the full extent of the involved area. For less sophisticated treatments, the target and critical organs are defined clinically, e.g. by palpation of the soft tissue tumour or using surface anatomy, and by plain radiographs, often obtained on a fluoroscopic simulator.

**Step 4. Dose planning**

The objective of dose planning is to design a treatment plan, such that the target is uniformly irradiated to an appropriate dose, whilst ensuring that critical organs do not exceed tolerance doses. Parameters that can be varied include:

- patient position
- beam size
- beam shape
- beam direction
- number of beams
- relative dose per beam (beam weight)
- wedging
- use of compensators.

**Step 5. Treatment verification**

It is essential that beams are correctly positioned and critical organs not over-irradiated. Beams for CT-planned radiotherapy are commonly verified by taking radiographs on a radiotherapy simulator prior to treatment; alternatively, this can also be done during any treatment with megavoltage radiographs or electronic portal imaging devices (EPIDs).

Increasingly, *in vivo* dosimetry, i.e. direct measurement of the dose delivered to the target and to adjacent critical normal structures, is being used as the gold standard of treatment verification for radical treatments. For this, thermoluminescence dosimeters are attached to relevant sites on the patient during one fraction of radiotherapy.

**Step 6. Treatment prescription and delivery**

The clinical oncologist prescribes the appropriate dose and fractionation schedule. Together with beam configuration information, these form a data-set completely describing the intended treatment. They are entered into a computer verification system on the linear accelerator and control set-up and delivery of each treatment.

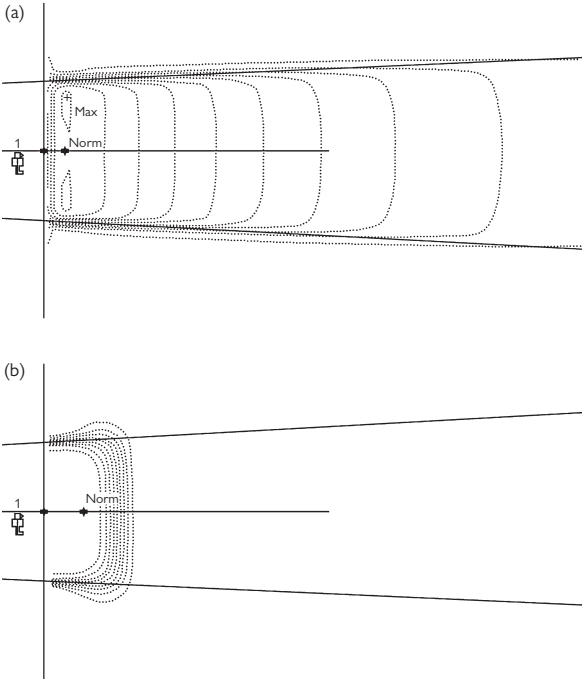

Fig. 4.1 (a) Isodose curves for open beams of 6MV X-rays. (b) Isodose curves for 12MeV electrons.

## Progress in external beam radiotherapy

### Three-dimensional planning

Perhaps the most significant change in radiotherapy practice in the past 20 years has been the direct use of cross-sectional imaging (most commonly using CT scanning) for radiotherapy planning (see Fig. 4.2). The advantages of CT planning are significant:

- tumour and critical structures are more accurately defined
- dose calculation is more precise
- the planning process can be truly 3D, offering potential for reduction in normal tissue damage, escalation of total dose to tumour, and improvement in the therapeutic index.

### Conformal treatment/multileaf collimators

It has always been the aim of radiotherapy to conform high-dose volume to the target. Normal practice until the 1990s was to use rectangular beams, with limited use of blocking. Inevitably, some normal tissue was unnecessarily irradiated to high doses. Improved levels of conformation can be achieved by positioning shaped alloy blocks in the beam and, automatically, with a feature on the modern linear accelerator known as multileaf collimators (MLCs). Here, the beam can be shaped under computer control by sliding a series of 0.5cm-wide leaves into the beam.

By minimizing the amount of normal tissue irradiated to high dose, it may be possible to deliver higher doses to the target, thereby improving tumour control without increasing morbidity.

### Further reading

Royal College of Radiologists. Radiotherapy dose-fractionation. Guidance BFCO(061). London: Royal College of Radiologists. Available at: <http://www.rcr.ac.uk/publications.aspx?PageID=149&PublicationID=229> (accessed 30 June 2009).

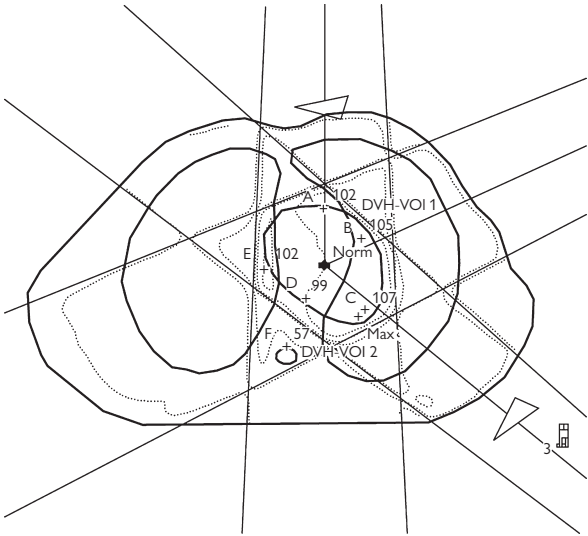

Fig. 4.2 Three radiotherapy beams converging on a CT-defined volume of lung cancer.

## Recent advances in external beam radiotherapy

In recent years, major technological advances have contributed to important changes in the practice of EBRT. Together, they have improved:

- the accuracy and precision of treatment
- the minimization of radiation exposure to organs at risk
- the ability to deliver higher doses of radiation to the tumour, with improved local tumour control.

### Volume definition

All centres now have their own high-resolution CT simulators, whilst previously planning scans were performed on diagnostic scanners. The tumour volume for even palliative treatments can now be accurately defined in 3D. For radical treatments, it is now possible to fuse CT images with other diagnostic modalities, including MRI and PET, further improving the accuracy of definition of the tumour volume.

### Image-guided radiotherapy

Radiotherapists have always recognized the need to allow for discrepancies between the planned treatment volume and the volume of tissue that actually receives irradiation. Traditionally, a margin of ~1cm was added to the CTV to allow for errors in patient positioning and set-up, and movement of the patient, the tumour, and organs at risk, both between and during fractions of radiotherapy.

Previously, confirmation of the accuracy of treatment required the taking of a megavoltage X-ray of the exit beam during a small part of the treatment exposure. These images are of limited value because of their poor quality.

Port films have now been replaced by EPIDs. So-called online imaging can be performed at the start of a treatment fraction in order to correct any misalignment, whilst offline images can be reviewed by radiographers or clinicians after the treatment fraction has been delivered (e.g. to compare a series of fractions to look for repeated errors in the set-up).

Whilst previously confirmation of a correct set-up relied simply on the comparison of bony landmarks between the treatment plan and portal images, the tumour itself can now be imaged during radiotherapy:

- fiducial markers, e.g. gold seeds, can be implanted into the prostate
- ultrasound imaging can confirm the position of, e.g. the prostate gland
- cone beam CT, mounted on the linear accelerator, allows online 3D imaging of the tumour target.

### Inverse planned intensity-modulated radiotherapy

Whilst conventional radiotherapy uses treatment beams that deliver a uniform dose across the beam, this dose can be varied in a computerized optimization process, based on a set of dose constraints for the relevant normal organs at risk and prescribed doses to the tumour targets (CTV and GTV). To achieve these dose constraints, the distribution of the radiation beam intensity is modulated across each beam:

- step and shoot technique—the beam intensity is modulated by superimposing a number of static uniform intensity segments
- dynamic MLC delivery—a shaped sliding window passes across the field during treatment
- tomotherapy—treatment delivered with multiple arcs, with the intensity of each modulated by special dynamic MLCs.

IMRT has already demonstrated benefits in the treatment of prostate and head and neck cancers, with reduced normal tissue late effects but equivalent control of cancer, when compared with conventional radiotherapy. Encouraging results have been reported at other sites, including lung and gynaecological cancers, and it is anticipated that this approach may replace 3D conformal radiotherapy (CRT) for many radical treatments. This treatment requires careful voluming of the tumour and all surrounding normal tissues on each slice of the planning scan, with typical times for volume definition of at least 2h per patient, and considerably increases the workload of the physics team.

### Four-dimensional therapy planning and delivery

The delivery of radical radiotherapy to mobile structures, such as lung cancers, which move with respiration can be made more precise using respiratory gating to link CT planning in four-dimensional (4D) (tumour volume drawn at each anatomical level, according to separate phases of the respiratory cycle) to the delivery of treatment limited to the expiratory phase of respiration which provides maximal reliable tumour coverage with the smallest treatment fields.

### Stereotactic radiotherapy

Since the 1990s, this treatment modality has become established for the treatment of a number of intracranial conditions, including benign tumours and arteriovenous (AV) malformations. Using an external 3D coordinate system, along with a stereotactic fixation system, it is possible to treat small lesions ( $<1\text{cm}^3$ ) with high precision (1–2mm). Typically, the treatment comprises 1–3 large fractions (12–20Gy).

Recently, this approach has been used successfully in the treatment of small malignancies in the brain, lung, and liver. The accuracy of these treatments at sites unsuitable for localization frames is facilitated by IGRT techniques, as described previously.

## Electron beam therapy

Although electron radiation is radiobiologically equivalent to photon radiation, in terms of its effects on normal and malignant cells, the physical characteristics of electron beams have advantages over photon beams in the treatment of some anatomical sites. Unlike photons, electrons possess charge and so interact frequently, as they penetrate tissue; the resulting energy loss leads to a well-defined range in tissue. The radiation dose deposited beyond a certain depth in tissue is negligible (see Fig. 4.3). This allows treatment of target volumes lying within a few cm of the skin's surface, whilst sparing any underlying critical structures.

### Electron versus photon radiotherapy

#### Electrons

- Limited tissue penetration
- Negligible exit dose from beam
- Particularly useful for superficial tumours, e.g. skin cancer, head and neck cancer, breast cancer
- Reduced dose to normal tissues beneath target, e.g. spinal cord, lung

#### Photons

- Suitable tissue penetration characteristics for the treatment of deep-seated cancers
- Skin sparing
- Beam characteristics facilitate beam matching and crossfire treatment plans

### Production of electron beams

Most radiation therapy facilities have high-energy linear accelerators, capable of producing both X-ray and electron beams.

Since electrons scatter significantly in air, beam-defining cones or 'trimmer' bars are fitted to the head of the treatment machine in order to collimate the beam near the skin's surface. The beam may be shaped further, either by fitting a lead or 'cerrobend' aperture at the end of the cone (an electron cut-out) or by using a lead sheet laid directly on the skin to restrict exposure of electrons to the target area.

### Dosimetric characteristics of electron beams

The various dosimetric aspects of electron beams in homogeneous tissue are as follows.

#### Depth dose characteristics

The dose builds up slowly to a maximum value and then falls off rapidly, reaching nearly zero at a depth equal to the practical electron range.

#### Effect of incident energy

The depth of penetration of an electron beam is determined by its incident energy. The practical range (in cm) of an electron beam in water is:

$$R_p \approx E_0 / 2$$



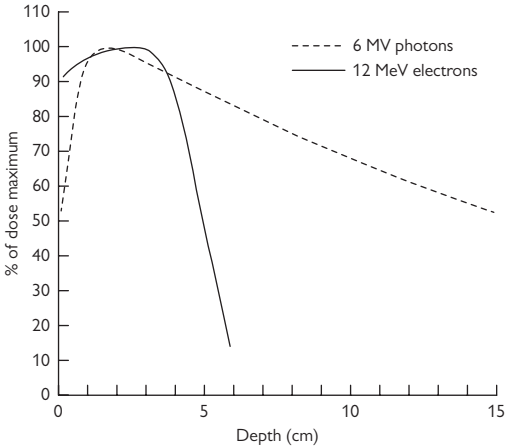

Fig. 4.3 Tissue penetration of different types of radiotherapy beams.

(where  $E_0$  is the incident beam energy expressed in MeV). Effectively all radiation effects are limited to within this practical range.

Similarly, the clinically useful range—the depth at which the dose falls to 80% of its maximum value—is estimated as:

$$d_{80} \approx E_0 / 3$$

The surface dose (commonly defined as the dose at 0.5mm depth) is significantly higher for an electron beam than for a megavoltage photon beam and ranges from about 85% of the dose maximum at low energies (<10MeV) to about 95% at higher energies.

Accelerators that offer an electron beam mode generally allow the selection of one of several available electron beam energies, most commonly in the range of 6–15MeV.

#### **Beam profile and penumbra**

The beam penumbra tends to be larger for electron beams than for photon beams. For electron beams, the dose falls to 90% of the central axis value, ~1cm inside the geometric field edge for depths near the dose maximum; a  $10 \times 10\text{cm}^2$  beam, for instance, produces an 'effective' field size of only  $8 \times 8\text{cm}^2$ . The corresponding distance for a photon beam is only about 0.5cm. Thus, a larger electron beam is required to cover a given target to a clinically useful dose. This property of electron beams makes abutting of photon and electron beams problematical, since a uniform dose across a field junction cannot be achieved at all depths.

## Brachytherapy

A form of radiation treatment where the radiation sources are placed within, or close to, the tumour or target volume.

### Indications

- The extent of the neoplasm must be known precisely, as treatment is often given to a relatively small volume, and a 'geographic miss' of the tumour is a significant risk, resulting in recurrence of the tumour at the edge of the target volume.
- The site should be accessible for both inserting and removing sources and allowing satisfactory geometric positioning of those sources.

### Advantages

- The probability of local tumour control increases with increasing radiation dose, but so does the probability of normal tissue damage. Brachytherapy allows the delivery of a localized high radiation dose to a small tumour volume, increasing the chance of local control. There is a sharp fall-off of radiation dose in the surrounding normal tissue; therefore, the risks of complication are reduced.
- The overall duration of brachytherapy is short, generally 2–7 days. The constant low-dose irradiation takes advantage of the different rates of repair and repopulation of normal and malignant tissues to produce differential cell killing, enhancing the therapeutic ratio.
- Hypoxic cells are relatively resistant to radiation treatment. Reoxygenation may occur during low-dose rate radiotherapy, with initially resistant hypoxic cells becoming oxygenated and more radiosensitive during the course of brachytherapy.
- The dose distribution within the tumour volume is often not homogeneous. Treatment is often prescribed to the minimum dose received around the periphery of the treated volume. Areas close to the radiation sources in the centre of the tumour volume often receive up to twice this dose. Hypoxic cells are situated in avascular, sometimes necrotic, areas in the centre of the tumours, and the higher doses received in the centre may help to compensate for the relative radioresistance of these hypoxic cells.
- Irregular-shaped tumours can be treated by judicious positioning of radiation sources, and critical surrounding normal tissues can be avoided.

### Disadvantages

- Many sources emit  $\gamma$  rays, and nursing and medical staff may be exposed to low, but significant, doses of radiation from the patient. Staff exposure can be minimized by after-loading techniques or the use of low-energy radionuclides.
- Large tumours are usually unsuitable, although brachytherapy may be employed as a boost treatment, following a reduction in size by EBRT and/or chemotherapy.

- The radiation dose falls off rapidly from the sources, according to the inverse square law. In order to treat the required tissue volume adequately, accurate geometric positioning of the sources is critical. The spatial arrangement of sources used varies, depending on the type of source applicator, the anatomical position of the tumour, and the surrounding dose-limiting normal tissue. Accurate positioning of sources or applicators requires special skill and training, and this is not universally available.
- Surrounding structures, such as lymph nodes, that may contain overt or microscopic cancer will not be irradiated by the implant or intracavity treatment.

## Types

- Intracavity—radioactive material inserted into body cavities:
  - cervix/uterine cancer
  - bronchial cancer
  - oesophageal cancer
  - bile duct cancer.
- Interstitial—radioactive material inserted into tissues:
  - prostate cancer
  - breast cancer
  - head and neck cancer
  - anal cancer.
- Surface—radioactive material placed over tumour:
  - skin
  - eye.

Implants can be classified as manually inserted, after-loading, or remote after-loading. Manual insertion of radiation sources should be avoided, if possible, owing to the radiation hazards to operating staff and nurses. After-loading is when the radioactive material is loaded into hollow needles, catheters, or applicators that have been inserted into the tumour area previously. Manipulation of these 'cold' applicators carries no radiation hazard to medical and nursing staff, so that time can safely be taken to ensure optimal source geometry.

After-loading with radioactive material can be manual or remote (using machines such as the Selectron, commonly used to treat gynaecological cancer). For remote after-loading, stainless steel pellets containing, for example, caesium in glass are moved pneumatically from a computer-controlled, lead-lined safe into intrauterine and vaginal applicators. This completely eliminates irradiation of theatre and nursing staff.

Some remote after-loading devices work at a very high-dose rate, e.g. the Microselectron (high-intensity iridium sources) or the Cathetron (high-intensity cobalt sources), and treatment is delivered in a matter of minutes, often with a number of repeated outpatient fractions. Low-dose rate brachytherapy may require the sources to remain in place for many hours.

Most implants are of the removable type; the radiation sources are removed after delivery of the prescribed treatment dose. However, permanent implantations can be performed using relatively short half-life isotopes such as  $^{125}\text{I}$  or  $^{198}\text{Au}$ , which are implanted into the tumours in the form of seeds that remain in place after the radiation has decayed.

## Radionuclides

### $\gamma$ emitters

Radium was used for many years as the source of  $\gamma$  rays for brachytherapy. This is now obsolete. The major source of  $\gamma$  rays is not radium, but the gaseous daughter product radon. Radium tubes and needles must be gas-tight and frequently checked for leaks. The  $\gamma$  rays produced are relatively high-energy (average of 830keV), and thick lead shields are required to provide adequate radiation protection. Caesium-137 has no gaseous daughter products, a useful half-life of 30y, and a less penetrating 660keV  $\gamma$  ray, and it has largely replaced radium, especially for gynaecological work.

Iridium-192 is manufactured in the form of flexible wires and has many advantages over traditional radium or caesium needles for interstitial brachytherapy. Thin wires (0.3mm in diameter) can be inserted into flexible nylon tubes or after-loading needles previously implanted into the tumour. Thicker wires (0.6mm in diameter), in the form of hairpins, can be inserted directly into a tumour through suitable introducers. Iridium is also available in the form of seeds sealed in thin plastic coating, used frequently for gynaecological treatments with the Microselectron. Iridium produces a  $\gamma$  ray of 330keV, and lead shields of 2cm in thickness provide good protection for medical and nursing staff. The major disadvantage of iridium is the relatively short half-life (74 days), so that fresh material should be used for each interstitial implant.

Iodine-125 has a half-life of 59.6 days and is used for permanent implants of the prostate. As well as having a relatively short half-life, the  $\gamma$  rays produced by this radionuclide are of low energy (27–35keV), and little radiation is emitted from a patient, following the implant, thus allowing early discharge from hospital.

### $\beta$ emitters

The major use of plaques emitting  $\beta$  radiation is in the treatment of eye tumours. Plaques can be made of strontium-90 or ruthenium-106/rhodium-106.

## Dosimetry

Radioactive material is implanted into tissues, according to distribution rules that vary according to the system used. In Europe, the classical Parker–Paterson and Quimby systems have largely been superseded by the Paris system, which is particularly suitable for iridium wire implants. A wire of the same linear intensity is used, and sources are arranged in parallel, straight, and equidistant lines, 8–20mm apart. To compensate for ‘uncrossed’ ends, the wires are 20–30% longer than the length required to treat the tumour. In a volume implant, sources in cross-section should be arranged in either equilateral triangles or squares.

The dose to the tumour can be calculated manually, using graphs, such as Oxford cross line curves, or by computer. The basal dose rate (the mean of minimum values between sources) is first calculated. The treatment dose (e.g. 65Gy in 7 days) is prescribed to the reference dose line (85% of the basal dose).

The prescription point for surface applicators, such as moulds, and some intracavity treatment is usually 0.5–1cm from the applicator. A special case is intracavitary gynaecological treatment. The most frequently used prescribing point is the Manchester A point, defined as a point 2cm lateral to the uterine canal and 2cm above the cervical os. The dose calculated at this point is a good predictor of late radiation damage to the ureter, bladder, rectum, and other pelvic organs. The International Commission of Radiation Units (ICRU) *Report 38* has proposed that the volume (defined in height, thickness, and width enclosed by a 60Gy isodose line) should be used for reporting the absorbed dose, following gynaecological treatments.

### Future developments

There is increasing use of sophisticated 3D planning techniques incorporating CT or MRI scans to determine the dosage to the whole tumour and to critical normal tissues. As well as defining the dose in purely physical terms, the biological effects in different tissues may be expressed as biological effective doses.

Radiation exposure to staff has been reduced by the increased use of high-dose rate remote after-loading machines. The complication rate following fractionated high-dose gynaecological insertions is less than that following manually inserted low-dose sources. Continuous low-dose rate implants have largely been replaced by high-dose 'pulsed' insertions, with optimization of the dose distribution and more *homogeneous* irradiation of the target volume.

### Further reading

International Commission on Radiation Units (ICRU) (1985). *Report 38: dose and volume specification for reporting intra-cavity therapy in gynecology*. Bethesda: International Commission on Radiation Units.

Nag S (ed.) (1997). *Principles and practice of brachytherapy*. New York: Futura.

## Intraoperative radiotherapy

A fundamental problem with radiotherapy is targeting diseased tissues, whilst avoiding unaffected normal structures. Various approaches are possible, including intraoperative radiotherapy (IORT). Involved tissues can be surgically exposed and selectively treated with a single fraction of EBRT (either orthovoltage X-rays or electrons), with reduced morbidity to non-affected tissues. The principal drawbacks are:

- need for specialist additional equipment in the operating theatre
- need for radiation protection for staff in the presence of therapeutic (as opposed to diagnostic) radiation exposure
- need for the radiation oncologist to be present in theatre
- radiobiological effects of a single large exposure on adjacent normal tissues.

Long-term follow-up data are limited, but animal studies suggest that IORT exposures of up to 30Gy carry little risk of long-term sequelae, as long as radiosensitive normal structures, such as the major nerves, blood vessels, spinal cord, or small bowel, are kept out of the radiation field. The threshold for nerve damage is 20–25Gy, with a latent period of 6–9 months.

A further risk to be considered is the induction of malignancy. A number of studies in dogs have reported a high incidence of sarcomas induced by IORT, compared to other treatment modalities. Issues, such as treatment planning, are clearly complex, as only limited treatment volume data can be available preoperatively.

### Specific tumours

- *Rectal cancer*—may be helpful in both 1° and recurrent tumours.
- *Stomach and oesophagus*—doses of up to 20Gy appear safe.
- *Bile duct*—may have role in minimal residual disease, rather than for unresectable disease.
- *Pancreas*—although feasible, no proven benefits as yet.
- *Head and neck cancer*—safe, well tolerated, and encouraging results from limited number of centres; may be helpful if minimal residual disease or recurrent disease.
- *Brain*—poor results.
- *Other tumours*—may be of value in some paediatric cancers, breast cancer, and soft tissue sarcomas.

### Conclusions

IORT is a promising technique but is limited by the technical and logistic problems already outlined. The continued development of conformal planning and delivery techniques for EBRT may reduce the therapeutic gain that can be obtained from intraoperative treatment. In addition, CRT is more reproducible in set-up and poses no special problems in dosimetry and fractionation. The development of IORT continues to be restricted to clinical trials within a few specialist centres.



## The role of unsealed radionuclides

Nuclear medicine in oncology may be used to:

- localize the 1° tumour
- detect metastases
- monitor the response to therapy and detect recurrences
- deliver targeted radiotherapy

### Radiolabelled tracers

A radiopharmaceutical consists of a ligand attached to a radionuclide that emits  $\gamma$  rays. The distribution of the radiopharmaceutical may vary from the normal because of a pathological process, e.g. a malignant tumour. Such biochemical or functional changes in tumours cannot be detected by cross-sectional imaging such as CT or MRI. However, imaging by detection of radiopharmaceutical (scintigraphy) lacks the anatomical detail of CT or MRI, and information from different imaging modalities is often complementary.

Several radiopharmaceuticals are used for both diagnosis and treatment. Examples are iodine-123 and -131, which localize avidly in functioning thyroid tissue. Other simple radiopharmaceuticals are thallium-201 ( $^{201}\text{Tl}$ ) and gallium-67 ( $^{67}\text{Ga}$ ). The ideal radionuclide for scintigraphic imaging does not exist, but technetium-99m ( $^{99\text{m}}\text{Tc}$ ) has many favourable characteristics.

### Scintigraphic methods

Traditionally,  $\gamma$  cameras are used for scintigraphic imaging. Planar images and whole-body images are acquired during a period of several minutes by a stationary  $\gamma$  camera. With single-photon emission computerized tomography (SPECT), cross-sectional images can be obtained, using computer techniques similar to those in CT. The main advantages of SPECT are greater sensitivity and accurate 3D localization of lesions.

### Positron emission tomography

PET employs radionuclides that emit positrons and provides quantitative tomographic images. Glucose utilization is measured with  $^{18}\text{F}$ -labelled fluorodeoxyglucose, and cerebral blood flow has been studied with  $^{15}\text{O}$ -labelled water. PET scanning may be useful to identify 1° tumours and metastases and to study tumour vitality, cell turnover rates, and the metabolic response to therapy.

### Applications in diagnosis and follow-up

#### Bone scintigraphy

Bone scintigraphy is normally performed 2–4h after the injection of 550MBq of  $^{99\text{m}}\text{Tc}$ -labelled methylene diphosphonate ( $^{99\text{m}}\text{Tc}$ -medronate, MDP) or hydroxymethylene diphosphonate ( $^{99\text{m}}\text{Tc}$ -oxidronate, HDP). Multiple planar images or a whole-body survey of the skeleton are obtained. Skeletal scintigraphy has high sensitivity for the detection of 1° and metastatic bone lesions. In the absence of reactive osteoblastic activity, the lesion itself may appear on the bone scan as a 'cold' defect.



High sensitivity (80–100%) has been reported in patients with bone metastases from breast carcinoma, prostatic carcinoma, bronchogenic carcinoma, gastric carcinoma, osteogenic sarcoma, cervical carcinoma, Ewing's sarcoma, head and neck carcinomas, neuroblastoma, and ovarian carcinoma. Lower sensitivity (around 75%) has been found in melanoma, small-cell lung tumours, Hodgkin's disease, renal cell carcinoma (RCC), rhabdomyosarcoma, multiple myeloma, and bladder carcinoma.

### *Thyroid scintigraphy*

$^{131}\text{I}$  as radioiodine,  $^{123}\text{I}$  as sodium iodide, and  $^{99\text{m}}\text{Tc}$  as sodium pertechnetate are the radionuclides used for scintigraphic visualization of the thyroid gland. Although  $^{131}\text{I}$  is cheap and readily available, its major disadvantages are its long physical half-life and  $\alpha$  emissions, resulting in a considerable radiation dose to the thyroid and GI tract.  $^{123}\text{I}$  has excellent physical properties for imaging and a physical half-life of 13h, but its use is limited due to its cost.  $^{99\text{m}}\text{Tc}$  is trapped in the thyroid but is not organified, and it washes out from the gland over time.

The indications for thyroid scintigraphy in oncology are:

- evaluation of a solitary or dominant nodule
- follow-up after surgery for differentiated thyroid cancer.

### *Therapy with unsealed radioactive sources*

Targeted radiotherapy using tumour-seeking radiopharmaceuticals has been employed for almost half a century. The radiopharmaceutical should have specific affinity for tumour tissue, with a high target-to-background ratio and long retention time; the radiation emitted by the radioisotope should be sufficiently energetic for a therapeutic effect but be absorbed over a short distance to irradiate the tumour target only. Some of the clinically useful radiopharmaceuticals for therapy are  $^{131}\text{I}$ ,  $^{89}\text{Sr}$ ,  $^{32}\text{P}$ ,  $^{186}\text{Re}$ ,  $^{153}\text{Sm}$ , and  $^{90}\text{Y}$ .

### *Iodine-131 therapy in differentiated thyroid cancer*

$^{131}\text{I}$  has been used extensively in the treatment of thyrotoxicosis and in differentiated thyroid carcinoma after thyroidectomy.  $^{131}\text{I}$  is used for ablation of the remaining thyroid tissue, following total thyroidectomy, and for the treatment of recurrent and metastatic thyroid cancer.

### *$^{131}\text{I}$ -meta-iodobenzylguanidine (MIBG) therapy in neural crest tumours*

$^{131}\text{I}$ -MIBG has been used successfully for radionuclide therapy of neural crest tumours. Post-therapy scintigrams, 1wk after administration, can be obtained for further documentation. In patients with malignant pheochromocytoma, response is achieved in >50% of patients; with neuroblastoma, the response rate is 35%. Some success is reported with  $^{131}\text{I}$ -MIBG therapy for paraganglioma and medullary thyroid carcinoma.

### *Bone-seeking radiopharmaceuticals for metastatic bone disease*

Bone metastases occur in up to 85% of patients who have breast, lung, or prostate cancer. Bone-seeking radiopharmaceuticals have pharmacokinetic properties similar to those of either calcium or phosphate. Strontium-89 ( $^{89}\text{Sr}$ ) is a calcium analogue.  $^{32}\text{P}$ ,  $^{86}\text{Re}$ , hydroxyethylidine diphosphonate (HEDP), and  $^{153}\text{Sm}$  are all phosphate analogues.

Historically, intravenous (IV) injection of  $^{32}\text{P}$ -orthophosphate for the treatment of bone pain was effective, but bone marrow toxicity limited its widespread use.  $^{89}\text{Sr}$  was the first radioisotope licensed as a systemic treatment for bone metastases in prostate cancer. After IV administration of 150MBq of  $^{89}\text{Sr}$ , the radiopharmaceutical is avidly accumulated in areas of high bone turnover, such as reactive bone surrounding a metastasis. Myelosuppression can be expected after 6wk. After a single administration of  $^{89}\text{Sr}$ , in 75–80% of patients, pain is promptly relieved and progression of further bone disease is delayed, with the response lasting 1–6 months.

#### *Intracavitary therapy*

Injection of radiopharmaceuticals directly into the pleural cavity, pericardium, peritoneum, urinary bladder, cerebrospinal fluid (CSF), or cystic tumours offers the potential advantage of direct access of radiopharmaceuticals to tumour tissue, without a systemic burden. Colloids and monoclonal antibodies labelled with  $^{32}\text{P}$ ,  $^{90}\text{Y}$ , or  $^{131}\text{I}$  can be used for this purpose.

#### *Monoclonal antibodies*

Monoclonal antibodies (mAbs) were considered the ultimate 'magic bullets' for cancer therapy when introduced 20 years ago. The goal has been to develop antibodies that target active tumour cells specifically and act as carriers of radiation to treat the disease. At present, radio-immunotherapy has met with more problems than successes, and its future is uncertain.



## Total body irradiation

Treatment intensification with high doses of chemotherapy and/or radiotherapy is used to try to improve cure rates for sensitive tumours and to eradicate remaining bone marrow stem cells prior to transplantation, most commonly with donor stem cells.

### Aims of total body irradiation

- To eliminate any residual malignant disease.
- To ablate residual marrow to permit engraftment of donor peripheral stem cells or bone marrow.
- To produce immune suppression (especially for non-haplotype identical grafts).

### Indications for high-dose therapy

#### *Haematological malignancies*

- Prior to bone marrow or stem cell transplantation for relapsed disease, e.g. acute leukaemia, high-grade NHL, myeloma.

#### *Other malignancies*

- These include neuroblastoma.

#### *Types of haemopoietic reconstitution*

- Autologous—transplant may be peripheral stem cells or cryopreserved marrow obtained before high-dose therapy.
- Allogeneic—matched or mismatched (one haplotype identical) bone marrow is usually used and may be obtained from a family member or donor panel.

### Pre-treatment screening

- The patient's disease should be in remission.
- There should be adequate renal, cardiac, hepatic, and pulmonary function to cope with the toxicity of chemotherapy and total body irradiation (TBI).
- Exposure to medication with the same side effects as TBI, or likely to potentiate its side effects, should be assessed:
  - neurotoxicity with asparaginase
  - renal toxicity with platinum or ifosfamide
  - pulmonary toxicity with methotrexate (MTX) or bleomycin
  - cardiac toxicity with cyclophosphamide or anthracyclines.
- Consider the need for additional therapy to sites such as the CNS, testes, mediastinum, i.e. areas of sanctuary or bulk disease.

### Preparation

Anti-emetics, including a 5-HT antagonist, are given IV with dexamethasone, 1h before treatment starts. If additional sedation is required, phenobarbital or diazepam may be used. For very young children, anaesthesia with ketamine may be necessary.

## Technique

- Linear accelerator—optimum energy of around 6MV.
- Fractionated TBI is preferred for reasons of convenience.
- Patient lies on couch behind a Perspex sheet (to provide full dose to skin), either on their side or back and side alternately.
- Treatment is given by opposed fields for half of each treatment time.
- The couch is placed at an extended distance from the machine to obtain the field size required to cover the whole body.
- The dose distribution will be inhomogeneous because of variation in AP/PA separation along the body and because of density differences (especially the lung). This can be compensated for by using bolus or lung shielding but is unnecessary using schedules described here where doses do not exceed tolerance for any normal tissues.
- The organ most at risk is the lung.

## Calculation of dose

Paired lithium fluoride dose meters or diodes are used to measure the dose distribution throughout the body. These are placed on the skin at defined sites in the upper and lower lung, mediastinum, abdomen, and pelvis. Midline doses are taken as the average of AP and PA dose meter readings, or CT scanning of the whole body can be used with a planning computer to calculate doses throughout the body.

## Dose schedules

### Adults

The optimum fractionated doses are determined as 13.2–14.4Gy, depending on the point of dose prescription. The maximum lung dose is preferred, as this is the dose-limiting organ, and should not exceed 14.4Gy.

### Children

May tolerate slightly higher doses than adults. In the Medical Research Council (MRC) protocol, treatment is given in eight fractions of 1.8Gy over 4 days. Many other dose schedules are in common use and have been found by experience to be satisfactory.

## Toxicity of treatment

### Acute effects

- Nausea and vomiting commonly start about 6h after the first fraction.
- Parotid swelling—occurs in the first 24h and then resolves spontaneously, although often leaving a dry mouth.
- Hypotension.
- Fever—abolished by steroids.
- Diarrhoea—occurs at day 5 as a result of GI mucositis.
- Delayed toxicity.
- Pneumonitis presenting with dyspnoea and characteristic X-ray appearances.
- Somnolence due to transient demyelination occurs at 6–8wk and is characterized by sleepiness, anorexia, and, in some cases, nausea which settles spontaneously within 7–10 days.

*Late toxicity*

- Cataracts occur in <20% of patients; incidence increases at 2–6 years but then appears to plateau.
- Hormonal changes—azoospermia and amenorrhoea, with consequent sterility, are the norm; very occasionally, fertility has been maintained, leading to normal pregnancies, with no increased incidence of abnormalities in the offspring.
- Hypothyroidism may result from damage to the thyroid alone or in combination with pituitary damage.
- In children, there may be impaired production of growth hormone (GH) which, added to the effect of early epiphyseal fusion from TBI, results in stunting of growth.
- Induction of second malignancy—there is a 5-fold increase in the risk of second malignancies. Brain tumours may be attributed to TBI, and oral and rectal carcinomas have been reported.
- Malignancy of the lymphoid system may result from the prolonged immune suppression.

# Principles of chemotherapy

- Rationale for combination therapy 84
- Alkylating agents 85
- Anti-tumour antibiotics 86
- Anti-metabolites 88
- Cisplatin and derivatives 94
- Topoisomerase inhibitors 98
- Anti-microtubule agents 100
- Drug resistance 104
- Dose intensification 106
- Chemo-irradiation 108

## Rationale for combination therapy

Cytotoxic chemotherapy destroys cancer cells. Currently available drugs target:

- chemistry of nucleic acids
- DNA or RNA production
- mechanics of cell division (e.g. spindle poisons).

The discovery and development of cytotoxic agents has paralleled the understanding of the chemical processes involved. The lack of selectivity inherent in this approach has limited the ability to kill cancer cells, whilst leaving normal dividing cells unscathed.

Cytotoxic agents can be classified by:

- chemical properties or mechanisms of action
- source (e.g. natural products)
- propensity to be cell cycle- or phase-specific.

The following principles underlie the design of a potential combination chemotherapy regimen:

- each drug should have single-agent activity in that tumour type
- each drug should have a different mechanism of activity
- drugs with non-overlapping toxicity patterns are preferable
- drugs that work in different parts of the cell cycle should be selected
- drugs should not all share the same resistance mechanisms.

Combination therapy aims to increase the 'fractional cell kill', leading to improved overall response of the tumour. Higher doses of cytotoxic drugs tend to produce increased cell kill (at least within certain limits); thus, it is important not to compromise on the dose of each agent (hence the need to select drugs with non-overlapping toxicity).

- Tumour mass is usually composed of cells that are asynchronously dividing—thus, combinations of drugs that act at different points in the cell cycle will theoretically kill more cells.
- 'Multidrug resistance' (MDR) is displayed by some tumour types, resulting from, e.g. the expression of an efflux pump on the cell surface that drives the drug out of the cell.

More recently, so-called targeted therapies have been developed which aim to specifically inhibit some process of fundamental importance to the cancer cell—good examples are angiogenesis inhibition and blockade of EGFR. These drugs often target some aspect of oncogene function. These drugs already have an established place in the therapy of some cancers. However, there is still a lot of clinical research that needs to be done to determine the optimal way of integrating these agents with existing therapies to maximize benefits to the patient. See Chapter 10 and appropriate site-specific chapters in Part 4.



## Alkylating agents

The oldest anti-cancer cytotoxics alkylating agents are antiproliferative drugs, because they bind covalently via alkyl groups to DNA. Following cross-linking, there is thought to be arrest in G1-S transition, followed either by DNA repair or apoptosis.

### Clinical use

Extensively used to treat leukaemia and lymphoma, and they are also active in a wide range of solid cancers.

### Resistance

Resistance to alkylating agents is multifactorial and may differ between classes of alkylating agents; for example, resistance to nitrosoureas is probably mediated by an increased expression of the enzyme O6-alkyl transferase. In addition to enhanced DNA repair, resistant cells may exhibit an increased ability to detoxify alkylating agents. Such mechanisms include increased:

- glutathione
- metallothionein
- glutathione-S-transferase.

### Examples of alkylating agents

- *Melphalan* is a derivative of nitrogen mustard and the amino acid phenylalanine. The rationale behind this is that dividing cells might take up amino acids more rapidly (and hence melphalan), thus providing some tumour selectivity.
- *Chlorambucil* is the phenylbutyric acid derivative of nitrogen mustard, a well-absorbed alkylating agent that can be orally administered—with activity in both solid and haematological malignancies.
- *Cyclophosphamide* is extensively used in cytotoxic chemotherapy. Its major toxicities are marrow suppression, alopecia, nausea, and vomiting. As a result of its relative lack of non-haematological toxicities, it is used in high-dose chemotherapy regimens.
- *Ifosfamide* is an isomer of cyclophosphamide. Extensive metabolism of this agent occurs, liberating chloroacetaldehyde, which is thought to be responsible for some of the toxicity profile. It nearly always causes alopecia and haemorrhagic cystitis, but this can be circumvented by the co-administration of thiol mesna which is thought to chemically combine with acrolein, the metabolite thought to be responsible for this toxicity.
- Both *cyclophosphamide* and *ifosfamide* are pro-drugs activated by hepatic cytochrome P450 metabolism to produce nitrogen mustards.
- *Busulfan* has a special place in the treatment of CML. It is well absorbed from the GI tract. The dose-limiting toxicities are myelosuppression and hepatic veno-occlusive disease. It can also cause hyperpigmentation and, rarely, pulmonary interstitial fibrosis.
- *Carmustine* (BCNU (1,3-bis (2-chloroethyl)-1-nitrosourea)) is a small lipophilic molecule and is used to treat CNS tumours and as a conditioning agent in high-dose therapy.
- *Temozolomide* is a more recently developed agent that is active in glioma and melanoma.

## Anti-tumour antibiotics

### Anthracyclines

Anthracyclines (doxorubicin, daunorubicin, epirubicin, and idarubicin) are closely related structurally and have similar mechanisms of action and resistance, but they have different patterns of clinical activity and toxicity.

#### Pharmacology

The anthracyclines have several effects, and their specific mode of action is unclear.

- There are direct effects at the cell surface and also on signal transduction, specifically activation of protein kinase C-mediated cell signalling pathways. The role of these actions in mediating anthracycline cytotoxicity is undefined.
- Their ability to undergo reduction to highly reactive compounds and to generate free radicals has clinically important implications. The characteristic cardiotoxicity of anthracyclines appears due to the generation of free radicals in the heart where defence systems are less active.
- The major target of anthracyclines is the enzyme topoisomerase II (topo II). During cell division, topo II binds to DNA, forming a 'cleavable complex' that makes transient 'nicks' in DNA, allowing torsional strain in DNA to be released, after which strands rejoin. Anthracyclines bind to the cleavable complex, disrupting this process, thus leading to DNA strand breaks and cell death.

#### Drug resistance

Some tumours are inherently resistant to anthracyclines, whereas others initially respond but later become resistant.

The *MDR1* gene codes for a P-170 glycoprotein (Pgp) that is a naturally occurring cell surface pump. Its physiological function appears to be a protective mechanism, expelling toxic substances from the cell. Though expression is increased in some human cancers before treatment or at relapse, attempts to manipulate Pgp have had limited success.

A second efflux pump, associated with the expression of multidrug resistance-associated protein (*MRP*) gene, has been implicated in anthracycline resistance in the lab.

#### Pharmacokinetics and metabolism

After IV administration, anthracycline levels fall rapidly, as it is distributed and binds to tissue DNA. Subsequent metabolism and elimination lead to a slow fall in plasma concentrations over several days. Dose reductions are recommended for patients with abnormal liver biochemistry, as they are at risk of increased toxicity.

#### Clinical use

The anthracyclines are among the most active cytotoxic agents.

- Doxorubicin and epirubicin are commonly used in IV regimens against breast cancer, sarcoma, and haematological cancers.
- Daunorubicin and idarubicin (oral) have a major role in the treatment of acute leukaemia.

**Toxicity**

The dose-limiting acute toxicities are:

- myelosuppression and mucositis, both occurring 5–10 days after treatment
- alopecia—occurs but is reversible
- extravasation injury—can be severe, and there is no proven effective treatment.

Cumulative cardiotoxicity is specific to anthracyclines and appears to be caused by the accumulation of free radicals in the heart. It typically presents with heart failure, the risk of which is dose-related. At doxorubicin doses below 450mg/m<sup>2</sup>, the risk is <5% but increases substantially at higher doses. In most cases, this threshold allows a full course of anthracycline to be given without risk. Irradiation of the heart increases the risk of cardiotoxicity, as does pre-existing cardiac disease.

- Liposomal encapsulation of doxorubicin reduces cardiotoxicity.
- Epirubicin, daunorubicin, and idarubicin have less effect on the myocardium than doxorubicin.

**Mitoxantrone**

This agent binds to DNA and interacts with topo II, but it appears less potent in generating free radicals. It is also a substrate for Pgp. The main clinical use of mitoxantrone has been as an alternative to doxorubicin in advanced breast cancer, as it is substantially less cardiotoxic and less vesicant and causes less alopecia. However, mitoxantrone is less effective than doxorubicin. It has some activity against other solid tumours, including NHL and non-lymphocytic leukaemia.

**Dactinomycin (actinomycin-D)**

Dactinomycin binds strongly to DNA by intercalation and inhibits the synthesis of RNA and proteins. It also appears to be a substrate for the Pgp pump. It is especially active against childhood tumours.

**Mitomycin**

Mitomycin (MMC) is active against a range of solid tumours but is also used as a radiosensitizer in chemo-irradiation. MMC is used in combination with other cytotoxics to treat breast cancer, NSCLC, and GI cancer. It is used as a radiosensitizer in the treatment of anal cancer.

The most important toxicity of MMC is myelosuppression, especially thrombocytopenia, which is delayed and can be cumulative. Accordingly, MMC is given systemically every 6wk, in contrast to the 3-weekly schedules usually used for other anti-tumour antibiotics. Haemolytic-uraemic syndrome, pulmonary fibrosis, and cardiac complications are all uncommon side effects.

## Anti-metabolites

Anti-metabolites interfere with normal cellular metabolism of nucleic acids; they act with S-phase specificity (see Fig. 5.1). They include some of the most widely prescribed cytotoxic agents, the indications of which are not confined to treating malignancies.

### Anti-folates

Understanding anti-metabolite action necessitates the knowledge of folate biochemistry. The enzyme thymidylate synthase (TS) acts as a rate-limiting step in the synthesis of thymidylate, converting dUMP (2'-deoxyuridine 5'-triphosphate) into dTTP (2'-deoxythymidine 5'-triphosphate) by transferring a methyl group from  $\text{CH}_2\text{-FH}_4$ . The supply of reduced folate is maintained by the enzyme dihydrofolate reductase (DHFR).

### Methotrexate

Widely used in many cancers, MTX is frequently used in breast cancer, osteogenic sarcoma, GI cancers, and choriocarcinoma.

#### Pharmacology

MTX is well absorbed orally below  $25\text{mg}/\text{m}^2$  but is usually administered IV, except in maintenance regimens and the treatment of benign connective tissue diseases. There is some hepatic metabolism to the active drug 7-OH-MTX, and ~10% of the drug is cleared by biliary excretion. Dose adjustments are not usually necessary with hepatic dysfunction. Significant third-space effects occur in the presence of fluid collections (e.g. ascites, pleural effusions) and can increase toxicity through reduced clearance. MTX excretion can also be inhibited by probenecid, penicillins (and cephalosporins), and non-steroidal anti-inflammatory agents.

Common toxicities include mucositis, myelosuppression, and nephrotoxicity.

### Thymidylate synthase inhibitors

New agents have been developed that directly inhibit TS (in contrast to indirect inhibitors, e.g. fluorouracil and MTX) and interact with the folate-binding site of TS.

Raltitrexed causes prolonged inhibition of TS by enhanced retention in cells due to polyglutamation of the parent molecule. After IV administration, it has triphasic elimination, with a rapid initial fall in concentration, but a very prolonged final phase; 50% of the drug is renally excreted unchanged. It is active in breast and colorectal cancers, with toxicities including myelosuppression, diarrhoea, and transaminitis. It has not been licensed in many situations because of unpredictable severe toxicities.

### Fluoropyrimidines

These pro-drugs are intracellularly activated, and their products inhibit pyrimidine synthesis.

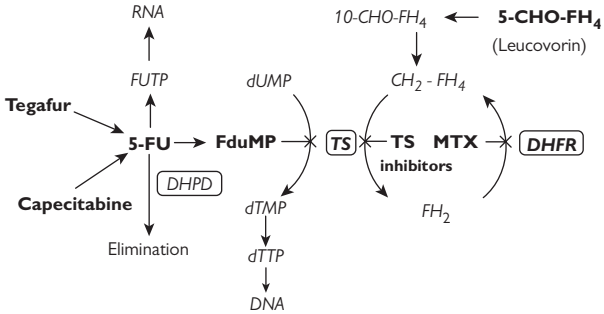

MTX Cytotoxics (MTX, methotrexate; 5-FU, fluorouracil; TS inhibitors include raltitrexed)

dTTP Normal metabolites

—X Indicates enzyme inhibition

**DHPD** Enzyme (TS, thymidylate synthase; DHPD, dihydropyrimidine dehydrogenase; DHFR, dihydrofolate reductase)

Fig. 5.1 Main sites of action of anti-metabolites.

## Fluorouracil

This is a widely prescribed agent, with particular activity in breast cancer, GI cancers, and head and neck tumours.

It is metabolized to FdUMP (5-fluoro-2-deoxyuridine 5-monophosphate), which, in the presence of CH<sub>2</sub>-FH<sub>4</sub>, forms a stable complex inhibiting TS. It also inhibits RNA synthesis and pre-ribosomal RNA processing.

### Pharmacology

Fluorouracil is given IV, both as a bolus and a prolonged infusion. It has a short initial half-life, with significant hepatic, renal, and lung clearance. Active metabolites (e.g. 5dUMP and FUTP) have variable pharmacokinetics.

Toxicities of fluorouracil include myelosuppression and, particularly with longer administration schedules, stomatitis and diarrhoea. Prolonged infusion overcomes the initial rapid clearance, resulting in differing toxicities with minimal bone marrow effects. Instead, cutaneous toxicity, known as hand-foot syndrome, occurs. Neurotoxicity and cardiotoxicity may also occur.

## Fluorouracil pro-drugs

### Uftoral® (tegafur with uracil)

Orally active, this is a mixture of tegafur given in combination with uracil in a molar ratio of 1:4. This agent is licensed and used in many countries, but not in the US. It has shown activity mainly in colorectal and other GI cancers.

**Capecitabine**

This is an orally active prodrug of fluorouracil. It is preferentially activated in tumour and liver tissue and has the potential to replace a prolonged or continuous infusion of fluorouracil. It has been shown to be active in a wide range of cancers and is licensed for breast and GI cancers. Further development and clinical trial work is ongoing to try to substitute this drug for fluorouracil in other clinical scenarios.

**2-fluoro-2'-deoxyuridine (floxuridine)**

Given IV, this agent can be metabolized both into fluorouracil and also directly into FdUMP, theoretically giving an increased efficacy. Its clinical use has largely been confined to hepatic artery infusion, because it is less toxic than single-agent fluorouracil used by this route for treating colon cancer. It is not licensed for use in the UK.

**Modulation of fluorouracil**

A number of agents have been combined with fluorouracil in order to increase either its efficacy or therapeutic index.

Fluorouracil and folinic acid (FA) combinations are the mainstay of treatment of colon cancer. FA is given by infusion, before or concomitant with fluorouracil. By increasing the supply of  $\text{CH}_2\text{-FH}_4$ , FA potentiates the interaction between fluorouracil and TS. Although more toxic, it has a higher response rate in advanced colorectal cancer with combined treatment than single-agent fluorouracil.

**Anti-purines**

Purine analogues are widely used to treat leukaemias and as immunosuppressives (azathioprine) and antivirals (aciclovir, ganciclovir).

Pemetrexed is a novel TS inhibitor which also inhibits DHFR and glycinamide ribonucleotide formyl transferase (GARFT). It is licensed for the treatment of mesothelioma and NSCLC. Its toxicity is reduced by the concomitant administration of B12 and folate supplements. 6-mercaptopurine (6-MP) and 6-thioguanine (6-TG) both inhibit *de novo* purine synthesis, and their nucleotide products are incorporated into DNA. Hypoxanthine guanine phosphoribosyl transferase (HGPRT) produces monophosphates that inhibit early stages of purine synthesis and then convert into triphosphates that are incorporated into DNA, causing strand breaks. There are synergistic effects with MTX, due to 5-phosphoribosylpyrophosphate (PRPP) build-up, facilitating phosphorylation by HGPRT. Resistance develops due to HGPRT deficiency and reduced substrate affinity. Variable oral bioavailability may contribute to some treatment failures in childhood acute lymphoblastic leukaemia (ALL).

Both drugs have a short half-life and are primarily metabolized—the important difference is that 6-MP is a substrate for xanthine oxidase, and dose alterations are necessary when co-administered with allopurinol. There is poor CSF penetration, but otherwise these agents are widely distributed.

The main toxicity is myelosuppression, but 6-MP can also cause hepatotoxicity. Nausea, vomiting, and mucositis can also occur, more commonly with 6-MP. The commonest indication is haematological malignancy—6-MP is used for maintenance therapy of ALL, and 6-TG is used for both remission induction and maintenance in acute myeloid leukaemia (AML).

## Cytosine analogues

### *Cytarabine (cytosine arabinoside, ara-C)*

Cytarabine is actively transported, and its metabolite ara-CTP is incorporated into DNA, inhibiting DNA polymerases and possibly phospholipid synthesis. Unlike gemcitabine, no further normal nucleotides are added, so that damaged DNA is susceptible to DNA repair.

Cytarabine is active in NHL and AML, but not in solid tumours. There is renal excretion of the deaminated compound, and, because of rapid clearance, better activity is observed when cytarabine is given by continuous infusion. Side effects are emesis, alopecia, and myelosuppression.

It can also cause 'ara-C syndrome' with fevers, myalgias, rash, keratoconjunctivitis, and arthralgias. Rarely, lung and pancreatic damage occurs.

### *Gemcitabine (2,2-difluorodeoxycytidine, dF-CTP)*

This fluorinated analogue has better membrane permeation and affinity for deoxycytidine kinase than cytarabine. Intracellular retention is prolonged, partly due to a unique self-potential, in which the bi- and triphosphates facilitate the phosphorylation of the parent compound, as well as inhibit its catabolism.

The active metabolite dF-CTP is incorporated into DNA, followed only by one more normal nucleotide, resulting in the protection of DNA from repair enzymes ('masked termination'). It is probably the saturable formation of dF-CTP that contributes to the clinical schedule dependency of gemcitabine, usually given IV, weekly for 3wk out of four.

Toxicities include flu-like symptoms, transaminitis, peripheral oedema, myelosuppression, and possible nephrotoxicity.

There is some evidence for synergy with cisplatin, the extent of which appears to be schedule-dependent. Gemcitabine is active in a wide range of cancers—most notably in pancreatic carcinoma where it is one of very few drugs that have modest survival advantage.

## Adenosine analogues

Three adenosine analogues have come into clinical practice, active in low-grade NHL, Waldenström's macroglobulinaemia, and chronic lymphocytic leukaemia (CLL). All have similar effects and interact with the enzyme adenosine deaminase (ADA), a deficiency of which causes severe combined immunodeficiency. Toxicity includes myelosuppression with particular effects on lymphocytes, including depression of CD3 and CD4 levels, and reduced natural killer (NK) cell activity.

### *Fludarabine*

Resistant to ADA, it is particularly useful in treating CLL. It is actively transported into the cells, and its mode of action is a consequence of phosphorylation, following which it is incorporated into DNA, and probably RNA, and may even cause topo II inhibition. Can cause haemolytic anaemia.

### *Pentostatin (2'-deoxycoformycin)*

Has a very high affinity for ADA, and the resultant complex is stable for over 24h, resulting in enzyme inhibition. Its major indication is treatment of hairy cell leukaemia. Actively transported into cells, it is phosphorylated and incorporated into DNA and also produces inhibitory deoxyadenosine triphosphate (dATP). It inhibits both DNA synthesis and DNA repair.

*Cladribine (2-chlorodeoxyadenosine)*

Resistant to ADA, phosphorylated and incorporated into DNA, and is used for hairy cell leukaemia.

**Hydroxycarbamide**

This oral agent inhibits ribonucleotide reductase, which reduces the availability of all deoxynucleotides. It crosses the blood–brain barrier and is used in myeloproliferative disorders. Toxicities are myelosuppression, GI toxicities, and sometimes hyperpigmentation of the skin.





## Cisplatin and derivatives

Cisplatin is one of the most active anti-cancer drugs in clinical use, with a very wide spectrum of anti-tumour activity. In view of its considerable toxicity profile, many attempts have been made to develop analogues with less toxicity, increased efficacy, or both.

### Carboplatin

A large number of analogues have been subject to clinical trials, but only carboplatin has emerged as a viable clinical candidate.

There is still a degree of controversy regarding the clinical equivalence of cisplatin and carboplatin; there are limited situations, such as germ cell tumours, where cisplatin still appears to be the agent of choice. However, carboplatin, in most other circumstances, has supplanted the use of cisplatin.

#### Side effects of carboplatin

##### Significant

- Thrombocytopenia, worse at day 14.
- Leucopenia, worse at day 14.

##### Less significant toxicities

- Renal.
- Neurological.
- Otological.
- Nausea and vomiting—occasionally.
- Alopecia—absent/mild.
- Visual disturbances—rarely.
- Allergy—in 2%.

#### Dosage of carboplatin

Initially, a dosage of carboplatin based on the body surface area resulted in a variable degree of thrombocytopenia, with a number of patients requiring platelet transfusion. Pharmacokinetically based dosing is now the adopted standard.

The simple pharmacokinetics of carboplatin, with clearance being dependent almost exclusively on renal mechanisms, allow a dosing formula to be derived. The dose required to achieve a specific area under the curve (AUC) can be calculated for an individual patient. The most widely used formula is:

$$\text{Dose} \approx H(\text{GFR} + 25)$$

where:

- dose is the total dose in mg to be given to the patient
- $H$  is the desired AUC in mg/mL.mm. Typical AUCs are between 4 and 7, depending on the frequency of administration, previous treatment, and the drugs being used in combination
- GFR is the glomerular filtration rate of the patient (mL/min), unadjusted for the surface area (should ideally be measured by an isotope method such as  $^{51}\text{CrEDTA}$  clearance, but a carefully performed 24h urinary creatinine clearance is also acceptable).

### *Activity of carboplatin*

Carboplatin can be regarded as a less toxic substitute for cisplatin and is used for similar indications. Patients resistant to cisplatin will also be resistant to carboplatin, and vice versa. However, the increased thrombocytopenia seen with carboplatin may be a disadvantage in some combinations, whilst reduced non-haematological toxicities may be an advantage in others. Furthermore, a low level of non-haematological toxicity makes carboplatin suitable for inclusion in high-dose regimens with bone marrow or stem cell rescue.

### *Pharmacokinetic interactions with carboplatin*

Unlike cisplatin, carboplatin does not affect hepatic cytochrome P450 enzyme, and pharmacokinetic interactions with other drugs seem to be rare.

### *Summary*

Carboplatin has major advantages over cisplatin, in terms of ease of administration and non-haematological toxicities, although the higher incidence of thrombocytopenia may be a problem in some circumstances. In the main, it can be regarded as an alternative to cisplatin, but current data suggest cisplatin should still be used for treating testicular teratoma. Unlike cisplatin, carboplatin can be used in high-dose regimens. Carboplatin should generally be dosed on a pharmacokinetic basis.

## **Cisplatin**

### *Mechanism of action*

Cisplatin binds directly to DNA, inhibiting synthesis by altering the DNA template via the formation of intra-strand and inter-strand cross-links.

These cross-links are generated by an aquated complex that acts as a bifunctional alkylating agent. Cytotoxic effects of cisplatin are cell cycle-independent, and synergy between cisplatin and anti-metabolites has been demonstrated both *in vitro* and in clinical trials. The mechanism behind this synergy has not been fully explained; the most commonly held hypothesis is that this is due to a malfunction in DNA repair processing.

### *Side effects of cisplatin*

Cisplatin is highly emetogenic. It produces a dose-dependent nephrotoxicity; it can also cause peripheral neuropathy, and, due to ototoxicity, it can produce tinnitus and high-tone deafness. Cisplatin is not very toxic to white cells or platelets but has the propensity to cause anaemia.

### *Dosage of cisplatin*

Cisplatin is used in a variety of dosage schedules. The standard dose limit is 100mg/m<sup>2</sup> as a single daily dose; higher doses have been explored in clinical trials, particularly in conjunction with neuroprotective agents. Alternate schedules, such as five daily injections of 20mg/m<sup>2</sup>, are favoured in the treatment of teratoma.

The initial clearance of cisplatin is rapid, followed by a much slower decline due to binding to plasma proteins. Clearance is prolonged in patients with renal insufficiency. Unlike carboplatin, there is no clear evidence of a pharmacodynamic/pharmacokinetic relationship with cisplatin; therefore, dosage is usually based on empirical body surface calculations.

### *Clinical indications for cisplatin*

Cisplatin has been a major step forward in the treatment of testicular cancer. In patients with metastatic disease, cisplatin-based combination therapy results in a complete clinical response in over 80% of patients, with the majority of these achieving long-term cure. Cisplatin is also a major component of treatment of ovarian cancer, genitourinary tumours, and other squamous carcinomas, particularly those in the head and neck and non-small-cell bronchogenic carcinoma.

Combinations of cisplatin with other cytotoxic agents are common and are used in a variety of human solid cancers and paediatric tumours.

### **Oxaliplatin**

Oxaliplatin is a platinum analogue that differs from carboplatin and cisplatin, in both chemical behaviour and possibly its mechanism of action. *In vitro* oxaliplatin has a broad spectrum of activity, with marked differences from the spectrum seen with cisplatin or carboplatin. In clinical practice, it is used extensively in colorectal cancer, both in the adjuvant and advanced disease settings. It has broad-spectrum activity and is also used in many other cancer types such as upper GI. Unfortunately, its cumulative dosage is limited by the development of a characteristic peripheral neuropathy, which, in most cases, is reversible on withdrawal of the drug.

### *Dosage of oxaliplatin*

Two commonly used regimens exist:

- 85mg/m<sup>2</sup> every 2wk as a 2–6h infusion
- 130mg/m<sup>2</sup> over a similar length of time, repeated every 3wk.

However, a multitude of studies exist, using a variety of different dosing regimens, including chronomodulated infusion together with fluorouracil.



## Topoisomerase inhibitors

Topoisomerase enzymes are a family of nuclear proteins with essential functions in regulating the topology of the DNA helix. Eukaryotics have two forms of topoisomerase enzyme.

- Topoisomerase I (topo I) binds to double-stranded DNA and cleaves and relegates one strand of duplex DNA. Relaxation of supercoiled DNA is then used during processes of replication, transcription, and recombination.
- Topo II creates transient double-stranded breakage of DNA, allowing the subsequent passage of a second intact DNA duplex through the break.

### Topoisomerase I inhibitors

Camptothecin (CPT) has been identified as the active constituent of an extract isolated from the Chinese tree *Camptotheca acuminata*. Mechanism of action studies demonstrated that CPT stabilized covalent adducts between genomic DNA and topo I. Early clinical studies with CPT observed anti-tumour activity in a variety of common solid tumours. However, a high rate of severe and unpredictable toxicities led to the discontinuation of the development of CPT.

To date, two main derivatives have been licensed—irinotecan and topotecan.

Both agents can be administered in a variety of IV schedules, with claimed differences in response and/or toxicity profiles.

#### Side effects

- Neutropenia—common.
- Diarrhoea—common (early or late).
- Thrombocytopenia.
- Anaemia.
- Alopecia.
- Nausea, vomiting.

#### Clinical pharmacology

Both CPT-11 and topotecan can be absorbed orally, with topotecan bio-availability of 30–50%; both are widely distributed throughout the body, with CSF topotecan concentrations 30–50% of simultaneous plasma concentrations.

Topotecan undergoes negligible metabolism and is primarily eliminated by the kidneys, with evidence for renal tubular secretion. A linear relationship between creatinine clearance and clearance of both total topotecan and lactone forms has been demonstrated.

CPT-11 is in itself relatively inactive and must be converted by carboxylesterases to 7-ethyl-10-hydroxycamptothecin (SN-38), which has potent topol inhibitory activity. Glucuronidation and biliary excretion are the principal mechanisms of elimination for SN-38. Particular caution and dose reduction are recommended for patients with liver dysfunction or Gilbert's syndrome.

## Topoisomerase II inhibitors

Etoposide and teniposide exert their action on topo II by:

- inhibiting the ability of the enzyme to relegate the cleaved DNA complex
- generating high levels of DNA with potentially toxic double-stranded breaks
- promoting mutation
- permanent double-stranded breaks
- illegitimate recombination
- apoptosis.

Etoposide and teniposide are poorly water-soluble and are formulated with a number of excipients, including polysorbate (etoposide) or Cremophor® EL (teniposide). Etoposide can be administered by either oral or IV routes, and teniposide only by IV injection.

Teniposide and etoposide are widely used in the treatment of adult and paediatric malignancies. Etoposide has been more broadly used in front-line therapy, particularly for small-cell lung cancer (SCLC) and germ cell tumours.

The pattern of toxicity is very similar between both agents and includes neutropenia, alopecia, mucositis, infusion-related blood pressure (BP) changes, and hypersensitivity reactions. Teniposide is not licensed for use in the UK.

### *Clinical pharmacology*

Etoposide absorption appears to be non-linear, with decreased bioavailability at doses above 200mg. Both etoposide and teniposide are heavily protein-bound; use in patients with low albumin concentrations will result in greater than expected systemic toxicity due to the larger free (unbound) drug concentrations.

Both etoposide and teniposide are extensively metabolized. Etoposide is more rapidly eliminated than teniposide. Linear relationships between etoposide systemic clearance and creatinine clearance have been described for both adult and paediatric patients.

## Anti-microtubule agents

Tubulin-interactive agents, commonly known as 'spindle poisons', have a long history of use in cancer treatment. They act by binding to specific sites on tubulin, a protein that polymerizes to form cellular microtubules.

Table 5.1 focuses on important anti-microtubule agents in clinical use. Tubulin is an important target for anti-cancer drug development; several anti-tubulin agents have significant anti-cancer activity in the clinic. The taxanes (paclitaxel and docetaxel) were the most encouraging development in anti-cancer chemotherapy of the 1990s.

Recent progress observed with taxanes has led to renewed interest in anti-microtubule analogues or drugs interacting with different sites on tubulin. In particular, agents with an improved pharmacological profile and/or activity in vinca/taxane-resistant cell lines are of interest. Several new anti-tubulin agents are in preclinical development, and methods of enhancing the cellular delivery of taxanes, whilst avoiding the toxic side effects, are the focus of many drug development efforts.



Table 5.1 Anti-microtubule agents

Class of spindle poison (mechanism of action)	Useful indications	Drug administration (IV doses in mg/m <sup>2</sup> )	Main toxicities	Pharmacokinetics and metabolism	Comments of clinical interest
Vincristine (VCR) (destabilization of polymerized tubulin ( $\beta$ -tubulin))	Leukaemias, lymphomas, paediatric tumours, SCLC, multiple myeloma	0.5–1.4 q 1–4wk (maximum total individual dose: 2mg)	Neuropathy	Metabolized in the liver	VCR induces MDR by Pgp. Mutations in $\alpha$ - and $\beta$ -tubulin proteins enhance stability against depolymerization
Vinblastine (VBL) (same as VCR)	Lymphomas, germ cell tumours, KS, breast cancer	6–10 q 2–4wk	Neutropenia, neuropathy	Metabolized in the liver	Neuropathy occurs less frequently than with VCR
Vindesine (VDS) (same as VCR)	NSCLC, breast cancer, prostate, lymphomas	2–4 q 1–3wk	Neutropenia, neuropathy	Metabolized in the liver	Randomized trials (breast, NSCLC, sarcomas, and melanoma) with VDS showed no advantage over treatments without VDS
Vinorelbine (NVB) (same as VCR)	NSCLC, breast cancer	25–30wk combinations: cisplatin (NSCLC) and doxorubicin or fluorouracil (breast); oral form in clinical development	Neutropenia, constipation, neuropathy	Metabolized in the liver	Selective binding to the tau family of microtubule-associated proteins $\rightarrow$ tubulin aggregation into spirals and paracrystals  NVB not active and associated with severe neurotoxicity in paclitaxel pre-treated breast cancer patients

(continued)

Table 5.1 (contd.)

Class of spindle poison (mechanism of action)	Useful indications	Drug administration (IV doses in mg/m <sup>2</sup> )	Main toxicities	Pharmacokinetics and metabolism	Comments of clinical interest
Paclitaxel (P) (microtubule stabilizer) (also anti-angiogenesis effect, disruption of Ki-Ras function, apoptosis induction by phosphorylation of bcl-2)	Ovarian, breast, and lung cancers (other tumours). Reproducible anti-tumour activity (response rate 15–25%) in platinum-resistant ovarian cancer stimulated further clinical development	135 (24h)–175 (3h) q 3wk. Weekly schedule is under investigation. Combinations: mainly with cisplatin or carboplatin (ovary) and doxorubicin (breast)	Neutropenia, neurotoxicity	Metabolized in the liver. Cisplatin → P; severe neutropenia; P → doxorubicin: more mucositis than the reverse sequence	Toxicities are sequence- and schedule-dependent. Steroid pre-medication is used to reduce hypersensitivity reactions. Water-soluble analogues and derivatives active in resistant cells of P are under development. Mutations in p53 cell lines confer sensitization to P. Resistance to P due to Pgp and/or alterations in the expression or structure of β-tubulin
Docetaxel (D) (microtubule stabilizer)	Breast cancer, lung cancer (other tumours). Reproducible anti-tumour activity (response rate 35–50%) in anthracycline-resistant breast cancer stimulated further clinical development	100 (1h) q 3wk, 75 q 3wk (if elevated LFTs). Weekly schedule is under investigation	Neutropenia, fluid retention syndrome (FRS)	Metabolized in the liver	Steroid pre-medication reduces and delays FRS. Tau and β4-tubulin expression correlate with D sensitivity in adenocarcinoma models

Estramustine phosphate (EP) (binds to the microtubule-associated proteins to promote microtubule disassembly)	Prostate cancer	560mg × 2/day orally (with meal)	GI	75% of oral EP is absorbed. Terminal half-life: 20–40h	Most responses observed in prostate cancer were subjective (objective response rate ~10%). EP has been combined with other anti-microtubules (P, VBL) and etoposide, with a clinical benefit in 30–60% of patients. Overexpression of $\beta$ (III and IVa)-tubulin and tau may play a role in resistance to EP
---	-----------------	----------------------------------	----	--	---

## Drug resistance

Most of the basic research into drug resistance has involved using pairs of sensitive and resistant tumour cells derived from the same parental cell line, usually by serial passage in increasing concentrations of the drug under investigation. This is an artificial situation, which often results in resistance that is really very substantial, with concentration variants in excess of 40–100-fold sometimes required to overcome such resistance. It is unclear whether this laboratory-derived resistance correlates with the types of clinical resistance that are outlined previously.

### Pharmacological resistance

The underlying concept of pharmacological resistance is that the dose of chemotherapy that can be safely given is insufficient to result in an effective concentration of the active drug at its target site. This may be due to:

- toxicity in other organs
- enhanced clearance of drugs
- physical barrier between the bloodstream and tumour cells (many tumours have avascular centres)
- *de novo* resistance—the tumour does not respond despite full-dose chemotherapy
- acquired resistance—initial response to chemotherapy, then the tumour fails to respond and regrows
- combination of *de novo* and acquired.

### Alteration of target or transport mechanisms

Tumour cells have the ability to mutate, such that the drug is either not taken up by the cell or, having been taken up, is detoxified more rapidly than normal. Alternatively, the actual target of the drug may change by mutation, such that it becomes impervious to the form of attack. Or the normal repair mechanisms that are present in all mammalian cells may become more active and repair damage produced by a cytotoxic agent in a more efficient manner, resulting in overall resistance to the agent.

### Classical multidrug resistance

'Classical' drug resistance has been the most studied form of this phenomenon in the laboratory and results from the overexpression of a 170Da glycoprotein known as P-170 glycoprotein (Pgp). This spans the outer cell membrane and acts as an energy-dependent drug efflux pump. Thus, as the drug enters the tumour cell by diffusion or transport, the drug in the interior of the cell is picked up and effluxed into the extracellular environment. This reduces the effective concentration of the drug within the cell and allows the cell to express resistance to the agent in question.

The development of this form of resistance is most commonly associated with exposure to the anti-tumour antibiotics, the anthracyclines, taxanes, and etoposide. In fact, resistance to one of this group of agents usually confers resistance to the other groups in addition, thereby leading to the phenomenon of 'multidrug resistance'.

### Multidrug resistance-associated protein

This protein is one member of a family of proteins that also act as energy-dependent pumps, in this case resulting in drug efflux or sequestration of the drug within intracytoplasmic organelles or vacuoles. The most studied member of this family of proteins is a 190kDa protein that has a similar substrate specificity to Pgp but is usually associated with less resistance to the taxanes. The clinical relevance of this form of resistance is less clear than with Pgp.

### Glutathione

Glutathione is the predominant cellular thiol and participates in a complex biochemical pathway that interacts with the alkylating function of some agents (including cisplatin). Glutathione overexpression in cell lines results in relative resistance to alkylating agent attack. In addition, glutathione is able to detoxify free radicals, which may be an important pathway of action for some cytotoxics, including doxorubicin. Clinical trials of glutathione depletion have been performed with somewhat equivocal results.

### Failure to engage apoptosis

The common final pathway of cell death for many cytotoxics is apoptosis. This is an active process within cells, somewhat akin to 'cell suicide'. The engagement of the apoptosis programme is a complex interacting pathway. At the centre of this is *p53*, the so-called 'guardian of the genome'. In cells that are unable to engage apoptosis, the damage done by cytotoxics can be 'ignored', and cell division continues. This results in clinical drug resistance. Gene therapy approaches to correct this apoptosis failure are being actively investigated.

### Summary

Clinical drug resistance is a major problem in oncology, and the underlying mechanisms are multifactorial. In any one patient, it is unclear to what extent each mechanism contributes. Nevertheless, the potential clinical benefits of mechanisms to circumvent drug resistance are enormous. Undoubtedly, other mechanisms of drug resistance will be found, as we come to understand more about the regulation of cell cycle, cell life, and cell death.

## Dose intensification

### Dose–response

The strategy of therapeutic dose intensification in oncology has been largely driven by experimental evidence suggesting that the drug resistance of cancer cells is often relative. Results of studies indicate that arbitrary dose reduction should be avoided and suggest that clinicians should consider the use of prophylactic antibiotics, haemopoietic growth factors, etc. in situations where neutropenia and its complications threaten to undermine the timely delivery of potentially curative chemotherapy.

### High-dose chemotherapy with haemopoietic support

In the clinic, dose escalation within a 'conventional' range has an inconsistent effect on response rates and, with some exceptions, a negligible survival impact. Dose escalation is complicated by increased toxicity. Substantial advances in haemopoietic support have allowed the investigation of high doses of chemotherapy in the clinic. Autografting, using either autologous marrow or cytokine-mobilized peripheral blood progenitors (PBPs), is seen to facilitate the administration of high doses of those drugs that are dose-limited by myelosuppression.

It was also discovered that administration of these factors, either at steady state or following myelosuppressive chemotherapy, resulted in the mobilization of haemopoietic progenitors from the bone marrow into peripheral blood. These 'PBPs' could be harvested by leucopheresis, then re-infused as haemopoietic rescue, following subsequent high-dose chemotherapy (HDC). PBP autografting is superior to marrow autografting, with shortened neutropenia and thrombocytopenia, and reduced mortality and morbidity.

Historically, HDC has generally been given as a form of consolidation, following conventional chemotherapy. Less frequently, it has been studied as 1° treatment. It can be administered in single or multiple cycles.

### Role of high-dose chemotherapy in the treatment of specific tumours

- Relapsed aggressive lymphoma—proven salvage treatment.
- Refractory lymphoma—10% remission.
- Poor prognosis NHL—first-line treatment.
- Multiple myeloma—first-line treatment.
- Relapsed refractory Hodgkin's disease—first-line treatment.
- Acute leukaemia—especially if no donor.
- Metastatic testicular germ cell tumours—relapse after second remission.

### Accelerated chemotherapy

An alternative approach to dose intensification is to shorten the interval between cycles of conventional chemotherapy, usually through granulocyte colony-stimulating factor (G-CSF) support. Preliminary results with this approach in adjuvant chemotherapy for high-risk breast cancer have been promising, but this approach is still considered experimental.



## Chemo-irradiation

Chemotherapy and radiotherapy are complementary; the integration of these treatment modalities underpins the successful treatment of a number of tumours. Chemotherapy reduces the burden of local diseases and eradicates systemic micrometastases, but effective loco-regional tumour control in some situations requires irradiation.

### Sequential combined therapy

The traditional approach to combining chemotherapy and radiotherapy has been to attempt to predict whether the eradication of systemic disease or local tumour control is of the most immediate concern, then to deliver the appropriate treatment first; the other treatment is delayed until completion of the first. The main difficulties are the uncertain behaviour of individual tumours and the inevitable delay in delivery of one treatment. Chemotherapy as the first-line treatment has the added potential benefit that, in downstaging the tumour, it may reduce both the volume of tissue that requires irradiation and the radiation dose required to control the tumour.

### Concurrent combined therapy

Problems are avoided by delivering chemotherapy and radiotherapy together. This approach has advantages and some disadvantages (see Table 5.2).

Ideally, cytotoxics chosen for chemo-irradiation regimens will have known activity against the tumour but will not have toxicities that overlap the effects of irradiation of the relevant region. Agents, such as cisplatin and fluorouracil, are particularly attractive because of their radiosensitizing effects. At least *in vitro*, the interactions of chemotherapy and radiotherapy are complex and schedule-dependent. An attempt must be made to minimize the normal tissue damage of radiation during combined therapy.

Table 5.2 Benefits and problems of concurrent combined therapy

Advantage	Disadvantage
No delay in either therapy	Increased toxicity
Additive cell kill by two therapies	Compromised dose of one or both treatments
Enhanced cell kill by radiosensitizing effects of chemotherapy	Large volume irradiated
Reduced likelihood of evolution of resistance to either therapy	Pharmacodynamic interactions (e.g. cell cycle effects)



### **Anal and bladder carcinomas**

For both these pelvic malignancies, chemo-irradiation offers the possibility of organ preservation and avoidance of a stoma. There is good evidence that pelvic irradiation, with concurrent fluorouracil and mitomycin, is the best established therapy for anal carcinoma. The combination of pelvic radiotherapy and cisplatin-based chemotherapy has proven successful in large phase II studies in muscle-involving transitional cell carcinoma of the bladder.

### **Head and neck cancer and oesophageal cancer**

Chemo-irradiation of intrathoracic tumours is hindered by the risk of serious morbidity, in particular, pneumonitis and oesophagitis. Chemo-irradiation is superior to radiation therapy alone for oesophageal cancer, but local failure rates remain high. Surgery after combined treatment may be the answer to this problem.

1° chemo-radiotherapy of head and neck cancers is widely used and can result in good response rates with some cures. This approach has some advantages over more radical surgical excision because of the possibility of organ and function preservation, with resultant reduction of morbidity. Surgical salvage can then be reserved for non-responding or relapsing cases.

### **Rectal cancer**

There is now clear evidence that the combination of fluoropyrimidine-based chemotherapy with EBRT leads to improved local control and enhanced survival. There remains an area of controversy over the use of preoperative chemo-radiation versus the use of the same in the post-operative phase for selected patients.

### **Non-small-cell lung cancer**

There is some controversy over the place of combined or sequential chemo-radiation in NSCLC. Clinical studies have shown modest outcome benefits, but at the cost of more toxicity and morbidity.



# Principles of symptom control in palliative care

- Introduction 112
- Symptom control 115
- Pain management 116
- Nausea and vomiting 126
- Hiccup 134
- Constipation 136
- Diarrhoea 138
- Cachexia and anorexia 140
- Respiratory symptoms 142
- Pruritus 146
- Lymphoedema 148
- Mouth care 150
- Control of psychological distress 153
- Symptom control at the end of life 154
- Integrated care pathway 156
- Further reading 156

## Introduction

*'Palliative care is an approach that improves the quality of life of patients and their families facing the problem associated with life-threatening illness, through the prevention and relief of suffering by means of early identification and impeccable assessment and treatment of pain and other problems, physical, psychosocial and spiritual.'*

(World Health Organization 2008 *Definition of palliative care*,  
 ☞ <http://www.who.int/cancer/palliative/definition/en/>)

- The majority of metastatic solid tumours in adults are incurable.
- Once diagnosed with a cancer, the optimal management of patients requires full involvement of the MDT from the point of diagnosis—often including the palliative care services.
- The goal of most treatment is to:
  - palliate symptoms
  - maximize QoL.
- To achieve these goals, the team should aim to ensure that:
  - the patient is able to benefit from the whole range of specialist medical, psychological, spiritual, and social interventions on offer
  - the patient is helped to 'live alongside their cancer'—to live as actively as possible until death
  - the apparent transition from 'active' oncological input to so-called 'terminal care' is managed in such a way as to cause minimal distress to both patient and relatives
  - both patient and carers feel supported during the course of the illness, with ongoing support subsequently available to bereaved relatives.

### 'The system'

- From diagnosis until death, it is likely that the patient will come into contact with multiple medical specialties and parallel organizations.
- The apparent complexity of the system can be bewildering for patients and carers. This is exacerbated if:
  - reaching the diagnosis was not straightforward
  - the hospital is split-site
  - a tertiary referral centre is involved.
- The aim is for a patient to feel that their investigations and subsequent treatment are delivered in a coordinated and logical manner, that continuity is maintained between appointments, and that they always know to whom to turn when faced with an unexpected event.
- Inherent limitations in communication between departments, the availability of medical notes, etc. have been minimized with the development of the MDT, the introduction of acute oncology services, and the introduction of the clinical nurse specialist (CNS).

### Problems with information giving and breaking bad news

- Poor communication and breaking bad news are consistently mentioned by patients and families as causes of stress and dissatisfaction.

- Common issues include patients leaving consultations:
  - unclear of their precise diagnosis/prognosis
  - unsure about the likely therapeutic benefits of treatment
  - wanting more information than has been provided.
- It is important to establish how much information the patient would like at each stage of their illness. Information giving should be tailored to the patient.
- It is increasingly common for letters dictated by the team after hospital appointments to be copied to the patient. These can often be a useful way of summarizing discussions from the visit, but check with the patient that they are happy to receive the letters.
- The number of patients who genuinely prefer to have little information and to leave everything up to the doctor (paternalistic model) is probably <5%.
- Dissatisfaction about the amount of information provided has a tendency to cause greater difficulty adjusting to the diagnosis, and consequently higher rates of anxiety and depression.
- Good communication reduces psychological morbidity by:
  - building trust
  - reducing uncertainty
  - allowing appropriate adjustment (practical and emotional).
- Breaking bad news is not an isolated event. It is an ongoing and recurring process which involves informing the patient and their family of the diagnosis, updating them on their progress, and ultimately preparing them for death.

#### *Breaking bad news: a ten-step approach*

This approach can be used as a general framework and adapted for specific situations. Remember a patient has a right, but not a duty, to hear bad news.

1. Preparation—know the facts. Arrange the meeting. Find out who the patient wants to be present. Arrange not to be disturbed (turn off beeps).
2. Establish what the patient already knows. Both doctors and the family generally underestimate the level of the patient's knowledge.
3. Establish whether the patient wants more information.
4. Allow denial. Denial is a defence and a way of coping. Allow the patient to control the amount of information.
5. Give a warning shot. This allows the patient time to consider their own reactions and whether they feel able to ask for more information.
6. Explain, if requested. Be clear and simple. Avoid harsh statements and medical jargon. Check understanding. Be as optimistic as possible.
7. Listen to concerns. Avoid premature reassurance.
8. Encourage the ventilation of feelings.
9. Summarize and make a plan—this minimizes confusion and uncertainty.
10. Offer availability. Communicating bad news is an ongoing process.

Include time for questions; ideally, provide written information, and give details of a contact person (often a CNS) who can be available to answer any queries that arise later. Be clear about the next appointment or investigation—its time, place, and purpose.

### Uncertainty

- Uncertainty is one of the most difficult problems for the human psyche to bear.
- It is a state in which most patients with cancer remain from the time they discover sinister symptoms and undergo diagnostic tests, until they complete treatment.
- Doctors are faced with a dilemma when trying to offer reassurance to an anxious patient, whilst being honest about an enigmatic disease with an uncertain outcome.
- It can be especially problematic when discussing clinical trials where uncertainty about the efficacy of treatment is inherent but must be discussed in order to gain informed consent.
- There is often fear of potential:
  - discomfort
  - disfigurement
  - disability
  - dependency
  - death.
- Valid concerns can be acknowledged and addressed. Conversely, the clinician must be alert to misconceptions or unfounded fears—reassurance may be possible.

### Discharge from follow-up

- Paradoxically, it is when the treatment ends that a patient may be in greatest need of support in re-appraising their lives and coping with 'survivorship'.
- Patients often gain (false) reassurance from surveillance programmes and may feel unsupported when regular specialist contact ends.
- This is exacerbated by the fact that there are few adult malignancies from which patients can be given the 'all clear'. Patients must cope with an ongoing risk of relapse.
- Sometimes, this uncertainty is almost too much to cope with. It may generate frequent requests for review and investigations. Conversely, it may cause withdrawal and isolation.

## Symptom control

For medical professionals involved in the day-to-day (and out-of-hours) management of patients with cancer, a large part of the clinical responsibility involves the assessment and treatment of a range of symptoms. Symptoms may be:

- directly attributable to the cancer
- a side effect or toxicity of palliative treatment
- physical, psychosocial, emotional, or spiritual
- due to an unrelated condition.

Therefore, each symptom requires careful assessment, so that the most appropriate management strategy can be adopted.

## Pain management

- Pain control is an obvious priority for patients with cancer, whether embarking on curative or palliative treatment.
- ~80% of pain due to cancer can be relieved with simple oral analgesics and adjuvant drugs, in accordance with World Health Organization (WHO) guidelines.
- The optimal management of cancer pain is effective treatment of the underlying disease. In the palliative setting, analgesic use is an established method of assessing response to anti-cancer therapy.
- Inadequate pain control may exacerbate many other problems, including:
  - fatigue
  - anorexia and nausea
  - constipation
  - depression, anxiety, and hopelessness
  - compliance with anti-cancer treatment.

Common causes of uncontrolled cancer pain include:

- *lack of sophistication in patient assessment*
  - misdiagnosis of the mechanism of pain
  - failure to detect general distress, which lowers the pain threshold
  - if pain distress exceeds pain severity, then analgesia will be insufficient
- *failure to adopt a systematic approach to analgesia*
  - an understanding of the WHO analgesic ladder is required
  - this includes a logical approach to the use of adjuvant analgesics
- *poor understanding of opioid pharmacology*
  - titration of opioids should be structured
  - doses given 'as required' (prn) should be appropriately proportionate
  - side effects should be anticipated, and prophylactic supportive medication prescribed.

### Categories of cancer pain

The importance of taking a good history cannot be overemphasized in pain management, as it allows the medical team to assess the likely mechanism(s) of pain, and therefore to select treatment accordingly.

#### *Is the pain acute or chronic?*

A diagnosis of cancer is not necessarily sufficient reason for a person to be in pain. Pain of sudden onset may suggest an acute complication of either the malignancy or the treatment for that malignancy, or of an unrelated cause, e.g. a new pathological fracture potentially requiring orthopaedic fixation, an acute intra-abdominal event necessitating surgical review, mucositis due to recent or ongoing chemo- and/or radiotherapy.

Conversely, chronic escalating pain may represent an underlying disease progression, e.g. soft tissue or nerve root infiltration.

#### *What is the nature of the pain?*

- *Somatic*—typically localized and persistent, e.g. bone metastases, localized inflammation such as cellulitis.
- *Visceral*—usually poorly localized, of variable intensity, and often with associated symptoms such as nausea, e.g. liver capsular stretch due to hepatic metastases, malignant abdominal lymphadenopathy, or smooth muscle spasm causing colic (bowel, bladder, renal, or biliary).



- *Neuropathic*—classically described as ‘shooting or burning pain’, usually following a dermatomal distribution, e.g. compression of a spinal nerve root.

### What is the patient’s interpretation of the pain?

Pain perception has a strong affective component and is greatly influenced by mood and morale. An understanding of the patient’s interpretation of his/her own pain will help to formulate a realistic management plan. For instance, do they have specific anxieties related to this new pain? Perhaps it has adversely affected their level of functioning, or maybe they view it as heralding the final stages of their illness. Addressing any anger, fear, or distress will increase the likelihood of achieving satisfactory pain control.

### Pharmacological pain relief

The use of the WHO analgesic ladder is based upon a number of simple principles:

- the strength of analgesia depends on the *severity of the pain*, rather than the stage of disease
- the medication should be prescribed regularly ‘around the clock’, with the aim of preventing pain from reoccurring. Appropriate prn medication must also be available for breakthrough pain at a dose that reflects the background regularly prescribed dose
- a single drug is rarely sufficient
- initiate the treatment with immediate-release formulations, and then switch to sustained-release formulations, once the pain is controlled and the dose has stabilized
- opioids are often used in combination with non-opioids
- adjuvant analgesia is chosen according to the cause and type of pain
- the WHO analgesic ladder is summarized in Fig. 6.1.

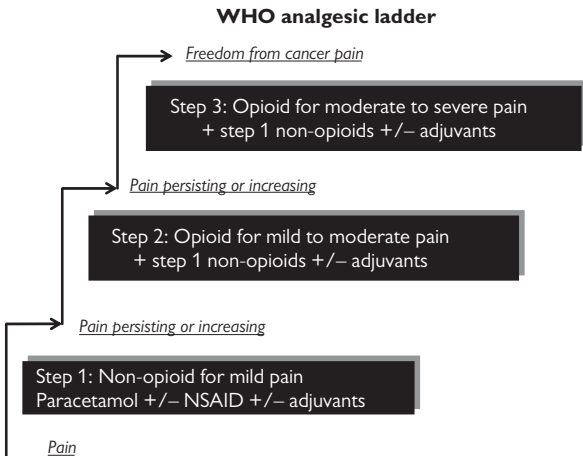

Fig. 6.1 The WHO analgesic ‘ladder’.

Adapted from a slide by Flora Watson.

**Step 1. Non-opioid analgesia***Paracetamol*

- Well tolerated.
- Acts centrally.
- Non-opioid analgesic and antipyretic.
- No anti-inflammatory action.
- Adverse reactions are rare at prescribed doses, i.e. up to 1g qds.

*Non-steroidal anti-inflammatory drugs*

- Important role in the management of cancer pain.
- Often used in combination with paracetamol (may have a synergistic action)  $\pm$  weak or strong opioids.
- If used continuously for weeks/months, be alert to the risks of:
  - gastric irritation—especially if also taking steroids
  - renal dysfunction.
- The most frequently prescribed are ibuprofen and diclofenac. Some units use naproxen, accepting the greater risk of GI morbidity.

**Step 2. Weak opioid analgesics**

The patient should continue with their regular non-opioid analgesics. If pain is not adequately controlled, then a regular weak opioid agonist can be added.

*Codeine*

- Methyl morphine, a pro-drug of morphine, metabolized to low-dose morphine.
- Demethylated by the CYP3A3/4 and CYP2D6 hepatic enzyme systems, yielding around 10% morphine. ~10% of Caucasians lack the enzyme and therefore do not respond to codeine. In patients who do respond, there remains substantial inter-individual variability in the analgesic response to codeine.
- Sub-therapeutic doses of codeine can often be found in over-the-counter (OTC) preparations (<30mg/tablet) and should be avoided.

*Dihydrocodeine*

- An analgesic in its own right. Does not depend upon the conversion to morphine for its analgesic activity.
- Low oral bioavailability and is therefore similar, mg for mg, to codeine when taken orally (one-tenth of the potency of morphine).

*Tramadol*

- Acts centrally.
- Works through both opioid receptors and serotonergic/noradrenergic inhibitory mechanisms, similar to antidepressants.
- Like codeine, 5–10% of Caucasians in Europe lack the CYP2D6 enzyme, in which case tramadol has little or no analgesic activity.

**Step 3. Strong opioid analgesics**

- If pain remains uncontrolled with a combination of regular non-opioid and weak opioid analgesics, continue the non-opioid, but substitute a strong opioid for the weak opioid agonist.
- The strong opioid of choice remains morphine administered orally.

- The body's endogenous opioid system consists of three peptide families:
  - enkephalins
  - endorphins
  - dynorphins.
- Each of the three peptide families has different receptor affinities for the mu, kappa, and delta receptors. These receptors are widely distributed throughout the CNS, particularly within the periaqueductal grey matter and throughout the spinal cord.
- Similarly, different exogenous opioid drugs prescribed to control pain exhibit different receptor affinities for these three opioid receptors. The differing efficacy and side effect profiles of different opioid drugs is, in part, due to these differences.

#### *Opioid titration on oral morphine*

- Titration should be initiated with a 4-hourly dose of immediate-release morphine (solution or tablets).
- The starting dose should be higher than the current medication.
- If moving up from step 2, then 10mg every 4h and for breakthrough might be suitable.
- The frail and elderly might require titration from a lower dose, e.g. 5mg 4-hourly.
- Increase the dose by 30–50% each day, until the pain is controlled.
- Once a stable dose is achieved, convert to either a 12-hourly (bd) or 24-hourly (od) modified-release morphine preparation. This provides the continuous background analgesia and should be accompanied by a prescription for normal-release morphine available for breakthrough pain.
- This prn dose should be one-sixth of the total 24h dose.
- In renal impairment, a smaller, less frequent dose may be appropriate.
- Titration can continue, once a patient has commenced modified-release morphine. The continued use of breakthrough medication is an indication that adequate pain control has not been achieved, and the titration should continue in steps of 30–50% every 24–48h. It is not good practice to simply add up the breakthrough requirements in a 24h period and add them into the total 24-hourly background modified-release dose. If a lot of breakthrough medication has been used, this might lead to a doubling (or more) of the daily opioid dose, which is never good practice. The risk of precipitating opioid toxicity is very high, especially if there is a degree of renal impairment.

#### *Common side effects on initiating opioid therapy*

- *Nausea:*
  - common during the titration phase
  - due to ↑ drug levels within the blood, stimulating the area postrema; ↓ gastric motility, leading to gastroparesis (delayed gastric emptying); constipation
  - tends to settle, once a stable dose of morphine is achieved
  - can be helped with a prokinetic anti-emetic (e.g. domperidone 10–120mg qds)
  - occasionally, a more potent dopamine antagonist is required (e.g. haloperidol 1.5–3mg nocte, or 1.5mg bd (main side effect is drowsiness)).

- **Constipation:**
  - most effectively managed with a combination of stimulant and softening laxative, with the dose titrated to effect
  - e.g. regular co-danthramer or co-danthrusate.
- **Drowsiness:**
  - typically improves after a few days, following the commencement of opioid or following titration to a stable dose.
- **Dry mouth:**
  - see 🔄 Mouth care, p. 150.

Morphine has an oral bioavailability of about 30% and undergoes extensive first-pass metabolism, and its metabolites (which are active) are excreted in the urine. Requirements vary greatly from patient to patient. It is important that the prn dose remains one-sixth to the daily morphine dose (as described in 🔄 Opioid titration on oral morphine, p. 119). Clinical practice and evidence from trials tell us that opioid responsiveness is a continuum, and no pain can be predicted as opioid-unresponsive. However, certain types of pain require larger doses of opioids and can be poorly opioid-responsive. Unacceptable side effects, such as sedation and hallucinations, can then be reached, before adequate pain control is achieved. It is in these situations, where the gap between efficacy and toxicity is narrow, that adjuvant analgesics become particularly important, often in the management of neuropathic pain.

### Opioid toxicity

- The aim is to avoid opioid toxicity. Never increase the opioid dose by  $\geq 50\%$  at a time. It is bad practice to double a dose of opioid, and there is never an indication to do this.
- It is very important to be able to recognize opioid toxicity and to take immediate remedial action.
- High-risk patients for opioid toxicity include those:
  - with renal impairment
  - with severe liver disease
  - in whom the dose has been escalated too quickly
  - with vivid dreams.
- Symptoms of opioid toxicity include:
  - vivid dreams
  - hallucinations, e.g. crawling insects, vague shadows
  - drowsiness
  - (potentially subtle) agitation/confusion
  - subtle paranoid delusions
  - miosis (pinpoint pupils)
  - myoclonic jerks (twitching)
  - allodynia (non-painful stimuli causing pain)
  - hyperalgesia (increased sensitivity to pain)
  - respiratory depression (particularly if the drug is accumulating).

### Managing opioid toxicity

- Reduce the opioid dose by 30–50%.
- In renal impairment, convert to short-acting (normal-release) opioid preparations to minimize the risk of accumulation.
- Check biochemistry and calcium.

- IV or subcutaneous (s/c) fluids may be indicated.
- Remember agitation and/or confusion can be misinterpreted as uncontrolled pain, leading to further opioids being administered and completing a vicious circle of opioid toxicity.
- The use of naloxone is very rarely indicated for use in opioid toxicity, as it will precipitate unacceptable and rapid pain escalation and distress.

#### *Reasons for considering switch to alternate opioid*

- Poor compliance via oral route.
- Intractable constipation.
- Poorly responsive pain and/or intolerable side effects.

#### *Alternative strong opioids*

- *Morphine* by s/c infusion:
  - water-soluble
  - 1g of morphine sulfate requires 24mL of water for injection to dissolve
  - twice the potency of oral morphine
  - renal excretion of active metabolites.
- *Diamorphine* by s/c infusion:
  - much more water- *and* fat-soluble than morphine
  - 1g of diamorphine hydrochloride dissolves in 1.6mL of water for injection, making it the drug of choice for small volume s/c infusions
  - greater fat solubility, compared to morphine, explains increased potency, penetrating the blood–brain barrier much more rapidly, gaining access to the brain and spinal cord
  - three times the potency when administered s/c, compared with oral morphine
  - renal excretion of active metabolites.
- *Fentanyl*:
  - extremely lipid-soluble, with totally different drug distribution and pharmacokinetics, compared to morphine
  - 100–150 times the potency, compared to oral morphine
  - lipid solubility permits transdermal administration. Controlled-release transdermal patches are useful for stable controlled pain
  - may cause less constipation and sedation
  - opioid toxicity may be more subtle and difficult to spot
  - the first patch requires cover with an alternative opioid, at least over the first 12h
  - less toxic in renal impairment
  - affected by significant liver function impairment and CYP450 drug interactions
  - renal excretion of inactive metabolites.
- *Alfentanil*:
  - similar to fentanyl
  - highly lipid-soluble and suitable for continuous s/c infusion
  - 30 times the potency of oral morphine
  - ten times the potency of s/c diamorphine
  - similar to fentanyl in renal and liver impairment.
  - renal excretion of inactive metabolites.

- **Oxycodone:**
  - similar molecule to morphine
  - different receptor profile
  - an alternative opioid when morphine poorly tolerated or intolerable morphine side effects
  - twice the potency of oral morphine
  - CYP450 metabolism (potential drug interactions)
  - renal excretion of active metabolites.
- **Hydromorphone:**
  - structurally very similar to morphine
  - 7.5 times as potent as oral morphine
  - possibly less toxic in renal impairment
  - renal excretion of (possibly) active metabolite.
- **Methadone:**
  - oral alternative to morphine, with similar toxicity profile
  - relative analgesic potency hard to predict
  - no active renal metabolites; safe in all, but the most severe, renal failure
  - predominantly excreted faecally
  - extensively metabolized in the liver and affected by CYP450 drug interactions
  - likely to accumulate in severe liver disease
  - complicated pharmacokinetics, and different dosing schemes make this a drug requiring experienced specialist supervision.

*Opioid potencies relative to oral morphine and 24h equianalgesic doses of opioids*

One fentanyl '25' patch provides 25 micrograms of fentanyl per hour or 600 micrograms every 24h. Potencies are given in Table 6.1.

**Table 6.1** Opioid potencies and doses

Opioid	Potency (relative to oral morphine)	24h dose
25 micrograms/h fentanyl patch	100–150 ×	One patch
Oral morphine	1 ×	60mg
s/c morphine	2 ×	30mg
s/c diamorphine	3 ×	20mg
Oral oxycodone	2 ×	30mg
Oral hydromorphone	7.5 ×	8mg
s/c alfentanil	30 ×	2mg

### Adjuvant analgesics

The use of adjuvant analgesics should be considered at every stage in pain management. Adjuvants are not primarily analgesics themselves but, when combined with analgesics, aim to improve pain control, often allowing opioid dose reduction, with fewer side effects. This may widen the gap between efficacy and toxicity. Appropriate selection of therapy requires an understanding of the mechanism of pain, e.g.:

- somatic
- visceral
- neuropathic
- mixed.

It is important to give each selection an appropriate trial of efficacy, but also to be prepared to withdraw ineffective medication. Otherwise, the patient could easily accumulate a vast array of tablets, requiring a complex timetable of administration without clear symptomatic benefit, but with a greatly increased risk of adverse side effects.

### Steroids

Indicated for:

- intracranial pressure (ICP)
- nerve root, spinal cord, or cauda equina compression
- distension of the liver capsule (due to metastatic disease or subcapsular haemorrhage)
- soft tissue infiltration.

Dexamethasone, up to 16mg/day, may be indicated initially, although the dose should be reviewed regularly and reduced to the minimum effective dose as soon as possible. Common side effects or symptoms seen when maintaining too high a dose for too long are:

- proximal myopathy affecting both upper and lower limbs
- fluid retention
- gastric irritation (from indigestion to haematemesis or perforation)
- insomnia and mood swings
- hyperglycaemia or deterioration in diabetic control
- iatrogenic Cushing's syndrome.

Dexamethasone has fewer mineralocorticoid-related effects, whilst prednisolone has less glucocorticoid activity.

Other adjuvant drugs include:

- *tricyclic antidepressants* (TCAs)—useful in neuropathic pain, e.g. amitriptyline or imipramine 10–25mg nocte, cautiously titrated upwards, aiming for 75–100mg daily if tolerated (lower starting dose for the frail and elderly). Anticholinergic side effects include sedation, confusion, dry mouth, blurred vision, postural hypotension, constipation, and urinary retention
- *anticonvulsants*—gabapentin is the only drug licensed for all types of neuropathic pain. Alternative drugs include sodium valproate, pregabalin, and carbamazepine. Anticonvulsants can be used instead of TCAs or in combination if either agent on their own affords insufficient pain control

- *N-methyl-D-aspartate* (NMDA) receptor antagonists—ketamine used for severe neuropathic pain refractory to combined strong opioid, antidepressant, and anti-epileptic. Central sensitization and wind-up pain characterized by hyperalgesia and allodynia
- *smooth muscle relaxants*—hyoscine butyl bromide for colic of bowel, urinary tract, or biliary tract, etc.
- *benzodiazepines*—for skeletal muscle spasm or neuropathic pain
- *bisphosphonates*—there is evidence from randomized placebo-controlled trials that bisphosphonates reduce pain due to skeletal metastatic disease in breast, prostate, and lung cancers and reduce bone-related complications such as pathological fractures. They also have a role in multiple myeloma. Analgesic effect takes up to 2wk to develop. Their role in other malignancies remains to be established. Treatment is currently IV (e.g. pamidronate or zoledronic acid on a 3–4-weekly schedule), although work continues to develop an oral agent with equivalent efficacy. Renal function and serum calcium (risk of hypocalcaemia) need to be monitored.

## Other interventions

### Anaesthetic techniques

- *Peripheral nerve block*—e.g. intercostal nerve block for painful rib metastasis or peripheral lung tumour/mesothelioma infiltrating the chest wall.
- *Coeliac plexus block*—for pancreatic cancer pain or other advanced upper GI malignancy.
- *Brachial plexus block*—for malignant axillary disease from, e.g. breast cancer, metastatic melanoma, or Pancoast tumour infiltrating the brachial plexus. The placement of a brachial plexus catheter could allow the continuous infusion of analgesia.

### Indications for spinal opioids

- Poor pain control, despite escalating opioid requirements.
- Opioid switch already tried or not appropriate.
- Unacceptable or intolerable systemic opioid side effects.

### Indications for epidural or intrathecal analgesia

- Pathological hip/pelvic fractures in patients unsuitable for surgical fixation.
- Intractable low back pain with metastatic disease affecting the lumbosacral spine.
- Advanced pelvic malignancy involving any of the pelvic organs.
- Recurrent rectal tumours causing intractable pain and/or tenesmus.
- Upper abdominal pain (coeliac plexus pain) can be managed with thoracic epidural initially prior to consideration of coeliac plexus block.
- Early referral to the pain team or a specialist anaesthetist should be considered.

### Neurosurgical techniques

- Spinal cord decompression/laminectomy,  $\pm$  stabilization.
- Open anterolateral cordotomy.
- Percutaneous cervical cordotomy.
- Implanted intrathecal pump.
- Neuromodulation—implanted spinal cord stimulator.



### *Orthopaedic surgery*

- Fixation of pathological fractures, hip nailing, hemi-arthroplasty, girdlestone, pelvic stabilization, humeral intramedullary wiring.
- Vertebroplasty with injection of cement into a collapsed vertebral body for bone pain.

### **Important practice point**

DO NOT FORGET TO REDUCE THE SYSTEMIC OPIOID DOSE BY 30–50%, FOLLOWING SUCCESSFUL NERVE BLOCK OR FIXATION OF AN UNSTABLE FRACTURE (to prevent opioid toxicity).

### *Palliative radiotherapy*

- EBRT can be effective in reducing pain due to local tumour effects, e.g. from skeletal metastases.
- Maximum benefit of radiotherapy can take several weeks to develop.
- Radiotherapy may initially exacerbate pain. Hence, pain control must be adequately addressed, whilst the patient is undergoing radiotherapy and in the weeks immediately afterwards.
- Bone-targeted radioisotopes, e.g. strontium-89, can be considered for diffuse pain from osteoblastic metastases unresponsive to conventional analgesia → the radioisotope is absorbed in areas of high bone turnover. Analgesic effect can take up to 3 months, and myelosuppression can be a significant toxicity.

### *Supportive care*

There are many other interventions that complement the medical approach to pain control and may have therapeutic benefit. These include:

- transcutaneous electrical nerve stimulation (TENS)
- occupational therapy
- physiotherapy
- acupuncture, aromatherapy, or reflexology
- relaxation therapies, including massage and hypnosis
- patient education and psychological support
- daycare can provide a framework and an environment for some, or all, of the above, as well as other creative therapies through raising self-esteem and distracting the focus away from unpleasant symptoms.

## Nausea and vomiting

- Occurs in up to 70% of patients with advanced cancer.
- An extremely unpleasant symptom, with many patients rating it as distressing as pain.
- Nausea and vomiting can occur as separate entities:
  - not every patient with nausea vomits
  - not every vomiting patient has nausea.

### Mechanisms

- As with pain control, appropriate management of nausea and vomiting requires a thorough assessment to identify a probable cause. A related neuropharmacological mechanism is then implicit, and a logical choice of anti-emetic can be made (see Fig. 6.2).
- When taking the history, particular attention should be paid to:
  - reduced appetite
  - early satiety
  - retching
  - small- or large-volume vomiting.
- There are many neurotransmitters, receptors, and neural pathways involved in nausea and vomiting, connecting the CNS with the periphery. The optimal choice of anti-emetic requires an understanding of:
  - the potential mechanism of the nausea
  - the site(s) of action of the anti-emetic selected.

### Neuroanatomy and description of receptors

- The *cerebral cortex* and *limbic system* respond to pain and various emotional stimuli and will affect the threshold for nausea and vomiting within the vomiting centre. The receptors of relevance within these neural pathways include gamma-amino butyric acid (GABA) receptors, 5-HT (serotonin), and the neurokinin-1 (NK<sub>1</sub>) receptor which selectively binds the emetogenic tachykinin substance P.
- The *area postrema* (AP) lies in the wall of the fourth ventricle and is outside the blood–brain barrier. This allows it to respond to drugs, toxins, and changes within both plasma and CSF biochemistry. The main receptors in this area are dopamine (D<sub>2</sub>) receptors, the 5-HT<sub>3</sub> serotonin subtype, and the (now ubiquitous) NK<sub>1</sub> receptor already mentioned.
- The *vomiting centre* (VC) lies within the medulla of the brainstem and within the blood–brain barrier. The most important receptors here include muscarinic acetylcholine receptors (ACh<sub>m</sub>), histamine (H<sub>1</sub>) receptors, 5-HT<sub>2</sub> serotonin receptor subtype, and again the NK<sub>1</sub> receptor as above. The VC receives afferent impulses from the other parts of the system and is in close proximity to other important brainstem nuclei, including the *nucleus of the tractus solitarius* and the *dorsal motor nucleus of the vagus*. These nuclei contain a large quantity of both serotonin (5-HT) and NK<sub>1</sub> receptors.
- The connections between the *vestibular apparatus* (contained within the bony labyrinths) and the VC and AP contain both ACh<sub>m</sub> and H<sub>1</sub> receptors.
- There are many pathways and receptors within the *GI tract*, but most importantly the 5-HT<sub>3</sub> and 5-HT<sub>4</sub> serotonin receptor subtypes, ACh<sub>m</sub>, and D<sub>2</sub>. The latter three receptors are involved in the regulation of GI motility.

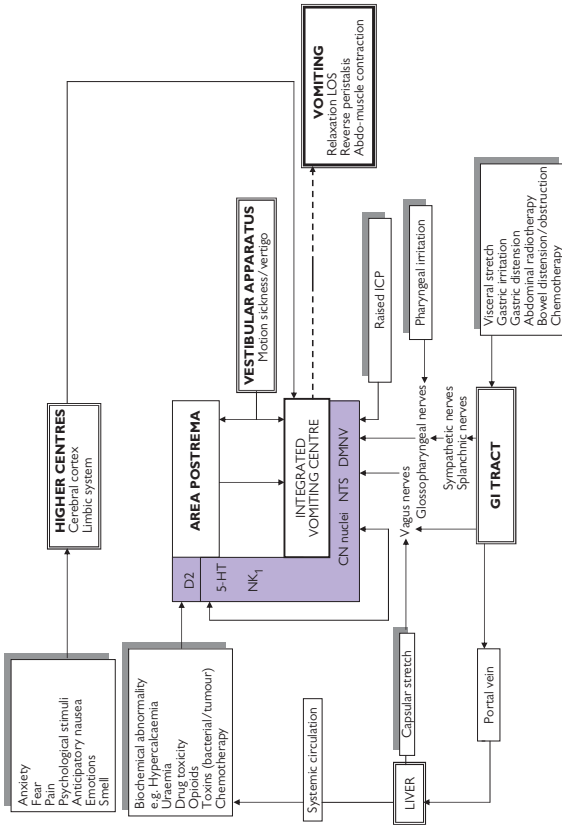

Fig. 6.2 Diagram of the neural mechanisms controlling vomiting.

$D_2$ , dopamine-2 receptors; 5-HT, 5-hydroxytryptamine receptors;  $NK_1$ , neurokinin-1 receptors; NTS, nucleus of the tractus solitarius; DMNV, dorsal motor nerve of vagus; CN, cranial nerve.

## Causes of nausea and vomiting

### Area postrema

Drugs, biochemical derangement, or blood-borne toxins will stimulate the AP. Serum biochemistry, including corrected calcium, and the renal function should be checked.

### Common metabolic causes

- $\uparrow$   $\text{Ca}^{2+}$  may be accompanied by dehydration, constipation, abdominal pain, and confusion. Alternatively, nausea/vomiting may be the only sign.
- Uraemia also causes nausea, often in the absence of other clinical signs.
- Hyponatraemia caused by advanced malignant disease or diuretic therapy.
- Secretion of inappropriate antidiuretic hormone (SIADH):
  - caused by specific malignancies
  - drugs—antidepressants, carbamazepine
  - chemotherapy
  - head injury.
- Opioids will cause gastric stasis and also stimulate the AP.
- Antibiotics, cytotoxic agents, and alcohol can cause damage to, or irritation of, the GI mucosa and stimulate the AP.
- Cytotoxic chemotherapy can cause acute and/or delayed emesis and anticipatory nausea and vomiting.

### Vomiting centre

- *Raised ICP* from brain tumours, metastatic disease, or other intracranial pathology. The history may be suggestive, e.g. early morning headaches associated with vomiting. Fundoscopy looking for papilloedema should be performed.
- *Pharyngeal irritation* due to a productive cough. Treat the cause, if appropriate, with antibiotics, and aid expectoration with mucolytics such as a saline nebulizer.
- *Liver capsular stretch* can cause nausea and vomiting, as well as pain. Steroids (dexamethasone) can often help with both.
- *Motion sickness*.

### Gastrointestinal causes

- *(Sub)acute obstruction*—a high index of suspicion, particularly if the patient is known to have intra-abdominal malignant disease. A history detailing the timing and nature of any vomiting (e.g. shortly after eating/hours after eating/unaltered food/faeculent vomitus/recent bowel habit/any flatus/associated pain, etc.) will guide in establishing the likely level of obstruction. Examination of the abdomen, including a rectal examination, and an abdominal X-ray (AXR) are needed. CT scan and small bowel series may assist the diagnosis of remediable causes.
- *Inoperable bowel obstruction*—dictated by the performance status, fitness for anaesthesia, and the nature of the bowel obstruction. Laparotomy is not indicated in cases of widespread intraperitoneal carcinomatosis with multiple sites of obstruction.
- *Squashed stomach*—as above, caused by intra-abdominal pathology limiting the free and normal distension of the stomach. Significant

ascites, large tumour masses, or liver metastases can cause delayed gastric emptying, as well as early satiety. The use of a prokinetic anti-emetic taken 20–30min before mealtimes, combined with an anti-flatulent antacid containing dimeticone after mealtimes, can help significantly.

### Other causes

- Pain, fear, and anxiety can all precipitate nausea and vomiting and lower the threshold of the VC for emesis.
- Radiotherapy may also cause sickness, particularly if the CNS or small bowel is within the radiation field.

### Drug profiles

- *Metoclopramide* and *domperidone*—both are dopamine antagonists and prokinetic anti-emetics with weak central action within the AP. Not always effective for biochemical or drug-induced nausea, but especially useful to aid gastric emptying. Metoclopramide works both by countering the dopamine inhibition of motility and stimulating motility as a 5-HT<sub>4</sub> agonist. Domperidone, however, works only by blocking the dopamine inhibition. Domperidone does not cross the blood–brain barrier and so does not cause extrapyramidal side effects.
- *Haloperidol*—potent dopamine receptor antagonist, useful for treating AP-mediated nausea, refractory to metoclopramide or domperidone. Watch for extrapyramidal side effects.
- *Cyclizine*—the drug of choice for VC- or vestibular apparatus-mediated nausea and vomiting. Antihistamine and anticholinergic activity. First choice for nausea and vomiting caused by raised ICP, motion sickness, liver capsule stretch, or pharyngeal irritation. Should not be combined with metoclopramide, as its anticholinergic action will negate the pro-motility effect of metoclopramide.
- *Levomepromazine*—phenothiazine with useful broad-spectrum anti-emetic profile. Blocks D<sub>2</sub>, ACh<sub>m</sub>, H<sub>1</sub>, and 5-HT<sub>2</sub> serotonin receptor subtype, as well as α<sub>2</sub> receptors. This last receptor is responsible for the risk of postural hypotension at higher doses, especially when fluid intake has been marginal because of refractory nausea and vomiting.
- *Lorazepam*—short-acting benzodiazepine that can be administered sublingually. Particularly useful as an adjuvant anti-emetic for anxiety and anticipatory nausea and vomiting.
- *Dexamethasone*—fluorinated corticosteroid, often used as part of an anti-emetic regime given with chemotherapy. It acts as an adjuvant anti-emetic with other drugs. Its mechanism of action is possibly by reducing the permeability of the blood–brain barrier and the AP to emetogenic substances and by reducing GABA and leu-enkephalin release within the brainstem.
- *Ondansetron/granisetrone*—specific 5-HT<sub>3</sub> serotonin receptor subtype antagonists. Narrow spectrum and specifically developed to treat acute nausea and vomiting associated with both chemo- and radiotherapy. Less effective with delayed nausea and vomiting. NOT to be used as an anti-emetic when other drugs have failed. Can cause significant constipation.

- **Aprepitant**—a highly selective antagonist of substance P at NK<sub>1</sub> receptors, developed specifically to treat the delayed emesis sometimes seen with highly emetogenic chemotherapy regimens. It has little or no affinity for 5-HT<sub>3</sub> serotonin, dopamine, or corticosteroid receptors. NK<sub>1</sub> receptors can be found in the VC and GI tract. Licensed in combination with a 5-HT<sub>3</sub> antagonist and corticosteroids (although concomitant steroids must be prescribed at 50% of the usual dose), aprepitant is typically prescribed on days 1–3 of a cycle of chemotherapy.

### Choice of drug

(See Table 6.2.)

- A first-line anti-emetic is selected, subject to identifying the most likely cause, and is administered via a suitable route.
- If vomiting prevents oral administration, other options include s/c, sublingual, buccal, rectal, IV, and intramuscular (IM) routes.
- Continuous s/c administration via a syringe driver guarantees drug administration in the vomiting patient.
- Anti-emetics should be prescribed regularly.
- Second-line or combination therapy should be introduced if symptoms persist after 24h.
- Reversible causes of nausea and vomiting should be addressed separately, e.g.:
  - correcting hypercalcaemia
  - optimizing hydration
  - stopping emetogenic drugs, wherever possible
  - draining ascites
  - managing bowel obstruction appropriately, etc.
- It should be remembered that nausea and vomiting in patients with cancer is often multifactorial. If the causes are not clear, or first-line therapy has failed, then levomepromazine is an appropriate subsequent choice of anti-emetic, as it acts at many different receptor sites. Its broad spectrum of activity means it is frequently effective, even when combinations of specific anti-emetics have been unsuccessful. Its anxiolytic and sedative effects can also be advantageous in this group of patients, although doses above 25mg/24h can frequently cause sedation and postural hypotension.
- Inoperable bowel obstruction is often treated on a surgical ward by 'drip and suck', deploying an uncomfortable nasogastric (NG) tube and IV fluids.
- A more conservative approach can be successful, using a combination of a broad-spectrum anti-emetic, such as levomepromazine, and the anticholinergic (antisecretory and antimotility) drug hyoscine butyl bromide.
- Sometimes, an empirical trial of s/c dexamethasone can also be added to the regime.
- Octreotide (a somatostatin analogue) can be useful in cases refractory to the above management.
- A venting gastrostomy may have to be considered in high duodenal or jejunal obstruction. This is essentially a feeding tube used in reverse and is very effective for refractory nausea and vomiting.

Table 6.2 Selection of anti-emetics

Causes of nausea/ vomiting	Anti-emetic	Class of drug	Example dose schedule	Common side effects
Chemotherapy (acute emesis, <24h)	Ondansetron	5-HT <sub>3</sub> antagonist	8mg bd PO	Constipation
	Dexamethasone	Corticosteroid	2–4mg bd PO for 1–3 days	Agitation/insomnia, gastric irritant
Chemotherapy (delayed emesis, >24h)	Metoclopramide	Peripherally acting prokinetic and AP anti-emetic	10–20mg qds PO	Restlessness, extrapyramidal effects
	Aprepitant	NK1 antagonist	3-day chemo pack or 80mg od PO	GI side effects, headache, dizziness
Anticipatory	Lorazepam	Benzodiazepine	1–2mg prn, max 4mg/24h	Sedation
Drugs, e.g. opioids, metabolic (whilst correcting the cause)	Haloperidol	Dopamine antagonist	1.5–3mg nocte PO or 0.5–1.5mg bd PO	Sedation, extrapyramidal effects
	Levomopromazine	Dopamine antagonist, antimuscarinic, antihistamine, and 5-HT <sub>2</sub> antagonist	6.25–12.5mg nocte PO or 6.25mg bd PO	Sedation, blurred vision, risk of urinary retention, postural hypotension
Gastric irritation, including radiotherapy	Lansoprazole	PPI	30mg od–bd PO	
	Ondansetron	5-HT <sub>3</sub> antagonist	8mg bd PO	Constipation
	Cyclizine	Antihistamine and anticholinergic	50mg tds PO/s/c	Drowsiness, dry mouth, blurred vision, risk of urinary retention

(continued)

Table 6.2 (contd.)

Causes of nausea/vomiting	Anti-emetic	Class of drug	Example dose schedule	Common side effects
Raised ICP	Dexamethasone	Corticosteroid	Up to 16mg/24h	Agitation/insomnia, gastric irritant
	Cyclizine	Antihistamine and anticholinergic	50mg tds PO or 150mg/24h/s/c	
Gastric stasis/subacute bowel obstruction	Metoclopramide, or Domperidone	Prokinetic Prokinetic	10–20mg qds PO/IV/s/c 10–20mg qds PO or as rectal suppository	Agitation. Discontinue if colicky pain develops. Central effects less likely with domperidone
Pharyngeal irritation, liver capsular stretch, motion sickness	Cyclizine	Antihistamine and anticholinergic	50mg tds or 150mg/24h s/c	Drowsiness, dry mouth, blurred vision, risk of urinary retention
Obstruction	Cyclizine	Antihistamine and anticholinergic	50mg tds or 150mg/24h s/c	Drowsiness, dry mouth, blurred vision, risk of urinary retention
	Haloperidol	Dopamine antagonist	2–3mg bd or 2–5mg/24h s/c	Sedation, extrapyramidal effects
	Dexamethasone	Corticosteroid	2–8mg bd s/c	Agitation/insomnia, gastric irritant
	± hyoscine butylbromide	Anti-spasmodic, anti-secretory	Up to 100mg/24h s/c	Dry mouth, blurred vision urinary retention
	± octreotide	Somatostatin analogue	Up to 1000 micrograms/24h s/c	Constipation
	Levomepromazine	Broad-spectrum phenothiazine anti-emetic	6.25–25mg/24h s/c	As described earlier in this table





## Hiccup

- Hiccup is a pathological respiratory reflex, part of a symptom complex originating and integrated within closely related brainstem nuclei and also the respiratory and vomiting centres.
- It is characterized by spasm of the diaphragm, resulting in sudden inspiration, followed by abrupt closure of the glottis.
- Over 90% of hiccups are thought to be caused by gastric distension.
- Gastroparesis, as a consequence of opioid therapy, can cause hiccup.
- Also caused by pathology around, or involving, the diaphragm:
  - disease around the lower oesophageal sphincter
  - the crura of the diaphragm
  - subphrenic abscess
  - lower lobe consolidation or empyema
  - disease infiltration of the diaphragm or phrenic nerve(s).
- Phrenic nerve infiltration can occur anywhere along the course of the nerve, including mediastinal disease involvement causing spasm of the diaphragm.
- Other causes include brain tumours and uraemia.

### Management

- Correct the correctable.
- Promote GI motility and gastric emptying.
- Drain empyema or pleural effusion.
- Drain subdiaphragmatic collection.
- Stenting of obstructing lower oesophageal tumour.
- Drain ascites.

### Traditional remedies

- These rely on pharyngeal stimulation which acts as a gating mechanism through negative feedback to the brainstem.
- Raising the partial pressure of carbon dioxide ( $p\text{CO}_2$ ) in the blood through breath-holding will raise the threshold for continued hiccuping. Rebreathing from a brown paper bag will have the same effect.
- Startling the patient often causes neck hyperextension, which, in turn, stimulates (via stretching) the pharynx.
- A couple of drams of alcohol ingested promptly.
- A couple of heaped teaspoonfuls of granulated sugar.
- Dry bread or biscuit.
- Rubbing the roof of the mouth at the junction of the soft and hard palate quickly and repetitively to and fro with a cotton bud.

### Medical treatments

- Saline nebulizer.
- Enhance GI motility, and encourage stomach emptying with metoclopramide 10–20mg or domperidone 20mg, 20–30min before mealtimes PO tds.
- Finish each meal with an anti-foaming, anti-flatulent antacid containing dimeticone, e.g. Maalox®.
- For relaxation of diaphragmatic spasm, consider baclofen or nifedipine.

- For phrenic nerve involvement, treat similarly to neuropathic pain. Steroid with an anti-neuropathic pain adjuvant, such as gabapentin or sodium valproate, may be helpful.
- Central depression of the hiccup reflex in the brainstem with midazolam or levomepromazine.
- (The use of chlorpromazine and haloperidol should be thought of as a last resort.)

## Constipation

### Causes

There are many potential causes of constipation in patients with malignancy.

- Drugs, particularly the more water-soluble opioid analgesics, drugs with either anticholinergic action or anticholinergic side effects, which include a number of the common anti-emetics, as well as the 5-HT<sub>3</sub> antagonists. Constipation is also associated with some forms of chemotherapy, e.g. vinca alkaloids.
- Dehydration due to inadequate fluid intake or 2° to vomiting, diuretic therapy, etc.
- Anorexia—reduced oral intake or change in dietary content.
- Immobility/general weakness and ‘cannot push’.
- Hypercalcaemia, particularly if accompanied by nausea and vomiting, dehydration, and abdominal pain.
- Spinal cord compression.
- Intestinal obstruction. Intrinsic compression due to malignancy, intraperitoneal disease causing stricture, or adhesion, or extrinsic compression from pelvic tumour. Post-surgery or post-radiotherapy adhesions.

### Presentation

- Decreased frequency, difficulty with bowel evacuation, or no bowel movements at all.
- Nausea and vomiting (may be accompanied by other symptoms and signs of bowel obstruction).
- Abdominal pain, often colicky.
- Overflow diarrhoea—the passage of fluid stool around faecal impaction. Highly likely if the diarrhoea follows an episode of untreated constipation and suggested by a history of passing or leaking very loose stool.
- Urinary retention.
- Acute confusional state, possibly accompanying infection or hypercalcaemia.

### Assessment

- History—to help identify precipitating factors or potentially reversible causes. This should include details of current home care package around the practical issues of toileting.
- Examination, including rectal examination.
- AXR only required to exclude obstruction or pseudo-obstruction, if suspected.
- Bloods—routine biochemistry, including serum Ca<sup>2+</sup>.

### Management

#### *Non-pharmacological*

- Increase fluid and dietary fibre intake, if at all possible. Obtain dietary advice.
- Mobilize.
- Maximize privacy and dignity.

### Pharmacological

- *Prophylaxis*—when prescribing an opioid, always consider prescribing a combined softener and stimulant laxative from the outset. Fentanyl patches may be less constipating than morphine due to the highly fat-soluble nature of the drug and an entirely different drug distribution within the body. Conversion to transdermal fentanyl might be considered if the pain is stable.
- *Osmotic agents*—these osmotically active compounds, within the bowel lumen, are not absorbed and retain water, softening the bowel content, increasing stool volume, and stimulating peristalsis. These include magnesium, citrate, and phosphate salts, and macrogols, as well as sugars that are not absorbed such as lactulose and sorbitol. Lactulose (a synthetic disaccharide) is commonly prescribed and causes unpleasant side effects of abdominal colic, bloating, and flatulence due to its breakdown and gas production within the bowel by the gut flora.
- *Other softeners*—these include poloxamer and docusate; the former is found in co-danthramer, and the latter in co-danthrusate or on its own as the stool softener docusate. Docusate does not have the disadvantages of lactulose described above, working more as a surface-wetting agent and enhancing the penetration of water into the stool.
- *Stimulant agents*—senna is a naturally occurring anthranoid laxative derived from plant extracts. Synthetic anthranoids include dantron found in co-danthramer and co-danthrusate. Along with the phenolics, such as bisacodyl and sodium picosulfate, they exert their effects by stimulating both secretion and motility via the enteric nervous system comprising Auerbach's and Meissner's plexus. Stimulant laxatives are contraindicated in intestinal obstruction. Dantron is licensed only for use in the palliative setting and is particularly effective in opioid-induced constipation. Patients must be warned that their urine may become discoloured.
- *Bulking agents*—useful in patients who are otherwise well and able to eat and drink relatively normally. Require a fluid intake of 2–3L per day, e.g. ispaghula husk. It is neither effective nor recommended to combat opioid-induced constipation.
- *Rectal preparations, e.g.:*
  - glycerin suppositories to soften, lubricate, stimulate, and facilitate the passage of hard stool from a loaded rectum
  - an arachis oil enema to soften stool at night, prior to a high-phosphate enema the following morning, to stimulate evacuation
  - bisocodyl stimulant suppositories or liquid are particularly useful to restore a pattern of bowel evacuation, following spinal cord compression
  - a range of osmotic micro-enema preparations are available such as Micolette® or Micralax®.

## Diarrhoea

The passage of abnormally loose stool; usually combined with increased frequency of bowel movement.

### Causes and management

- Exclude pathogens, especially bacterial, viral, and fungal; note *Clostridium difficile* or Norwalk virus/Norovirus.
- Exclude overflow diarrhoea, most frequently caused by the prescription of opioid therapy without a laxative. Requires rectal examination and intervention, if indicated.
- Too much laxative.
- Bowel resection.
- Post-radiotherapy diarrhoea:
  - loperamide
  - codeine
  - morphine
  - local steroid foam enema
  - ondansetron
  - octreotide.
- Consider fistula—diversion procedure/colostomy may be appropriate management.
- Malabsorption of pancreatic insufficiency—Creon®.
- Bacterial overgrowth within blind loops following surgical reconstruction after major surgery (Whipples/Roux-en-Y):
  - probiotics to encourage friendly bacteria—yoghurt drinks
  - metronidazole.
- Carcinoid syndrome:
  - ondansetron
  - octreotide.
- Cholegenic diarrhoea:
  - colestyramine.
- Candidal overgrowth causing secretory diarrhoea:
  - fluconazole.
- Autonomic neuropathy or post-lumbar sympathectomy:
  - clonidine.
- Drug-induced—chemotherapy, misoprostol, non-steroidal anti-inflammatory drugs (NSAIDs), antibiotics, laxatives:
  - stop causative drug, if possible.

*Loperamide* is a peripheral opioid receptor agonist with no central action, and hence no analgesic activity; 2mg is equivalent to 30mg of codeine or 15–30mg of morphine. *Loperamide* may, however, be more effective, as it is longer-acting:

- loperamide should be used alone initially
- then codeine alone
- then in combination
- and then loperamide and morphine could be tried as a combination.

Drugs may be lost from the bowel prematurely if the transit time is very short and diarrhoea severe. Opioid via continuous s/c infusion may be necessary to guarantee absorption and evaluate the efficacy.

*Correct the correctable, wherever possible.*



## Cachexia and anorexia

### Cachexia

- Involuntary increase in basal energy expenditure, culminating in the loss of both lean muscle and adipose tissue.
- Affects >85% of patients with advanced cancer.
- Often associated with anorexia. However, cachexia differs from starvation (in which muscle mass tends to be spared), because the associated loss of fat and lean body mass cannot be reversed by simply increasing the calorific intake.
- Most commonly seen in patients with advanced solid tumours, particularly those affecting the lungs or GI tract.
- The underlying causative mechanisms are unknown, although circulating cytokines, such as tumour necrosis factor (TNF), clearly play a role, causing metabolic abnormalities such as protein breakdown, lipolysis, and increased gluconeogenesis.
- Thought of as a chronic inflammatory state, the enormity of which relates directly to the degree and rate of weight loss.
- A major cause of symptoms towards the end of life, with multiple associated physical, psychological, and social co-morbidities. Often distressing to both the patient and their carers.

### Anorexia

- Reduced or absent appetite for food.
- May be associated with the fatigue and cachexia of advanced malignancy, without any other specific cause.
- However, assessment requires consideration of potentially reversible causes that may benefit from intervention, e.g.:
  - inadequate pain control
  - nausea
  - constipation
  - depression
  - metabolic abnormalities, e.g. hypercalcaemia, uraemia
  - infection, e.g. oral thrush
  - obstruction/ascites.

### Management

Correct reversible causes. Interventions usually do not influence cachexia.

#### *Non-pharmacological*

- Dietary advice—small, frequent meals. Eat when hungry. High-calorie, low-volume foods. Small amounts of alcohol as an appetite stimulant.
- Education—try to minimize any stress related to food. Encourage carers not to pressurize. Promote the enjoyment of food.
- Activity—maximize any potential for exercise.



### Pharmacological

- *Supplements*—high-protein, high-calorie, e.g. Ensure®.
- *Enteral/parenteral feeding* is occasionally appropriate during active anti-cancer therapy. It is rarely appropriate in the later stages of progressive disease.
- *Corticosteroids* may stimulate appetite, reduce nausea, and help in general by promoting a sense of well-being. They do not, however, increase lean body mass. The use of potent fluorinated corticosteroids, e.g. dexamethasone, should be considered only in the short term, as they will decrease muscle mass and cause proximal myopathy, cushingoid facies, and problems with upper GI irritation. Change to low-dose prednisolone 10–20mg daily maintenance for those with a better prognosis, or consider change to progestogen.
- *Progestogens* aid appetite and are more appropriate than steroids in the longer term, although evidence for useful weight gain is limited, e.g. megestrol acetate 160mg od.
  - Increased risk of thromboembolism.
  - Combinations of megestrol and ibuprofen have been shown to improve QoL and weight gain.
  - Similarly, medroxyprogesterone has been combined with celecoxib and found to stabilize weight and help generally with symptom control.
  - Neither combination increases lean body mass, but they increase both fat and total body water (not oedema), and so lead to weight gain. Inclusion of the NSAID probably helps by dampening down the chronic inflammatory response driving the weight loss.
- *Eicosapentanoic acid (EPA)* is one of the omega-3 essential fatty acids and can help dampen down the acute inflammatory response, as well as protect muscle against proteolysis-inducing factor. It is found in fish oil capsules and Prosure®. Pure EPA capsules can be obtained from most health food stores.

## Respiratory symptoms

### Causes of breathlessness in malignant disease

We become conscious of being short of breath when it is necessary to increase the rate and/or depth of respiration to keep pace with the body's gas exchange requirements for oxygen ( $O_2$ ) consumption and carbon dioxide ( $CO_2$ ) production. Dyspnoea becomes frightening and unpleasant when gas exchange is insufficient to support a given task.

Shortness of breath (SOB) in patients with metastatic malignancy is commonly multifactorial in origin. The patient must be fully assessed for potentially reversible causes.

#### Pulmonary

- Lung tumour.
- Pneumonia.
- Pleural effusion (if recurrent, consider pleurodesis).
- Lymphangitis carcinomatosa.
- Obstruction of large airways (see Chapter 33)  $\pm$  distal collapse.
- Concomitant chronic obstructive pulmonary disease (COPD).

#### Cardiovascular

- Pericardial effusion.
- Congestive cardiac failure.
- Pulmonary emboli (PEs).
- Superior vena cava (SVC) obstruction (see Chapter 32).
- Anaemia.
- Arrhythmias.

#### Chest wall and diaphragm

- Muscle weakness/fatigue.
- Carcinoma *en cuirasse*, i.e. restrictive malignant infiltration of the chest wall.
- Lytic bone metastases/pathological fracture(s) affecting the ribs.
- Pleurisy.
- Infiltration of the phrenic nerve at any point along its course from the emerging nerve roots, or throughout the mediastinum, or at the diaphragm.

#### Ventilation–perfusion mismatch

A large proportion of the above causes of SOB are due to ventilation–perfusion mismatch. The majority of useful gas exchange takes place at the lung bases. Frequently, pathology interferes with this process:

- pleural effusion
- empyema
- basal consolidation
- multiple metastases
- lung tumour and basal collapse
- poor basal expansion due to paralysis of the diaphragm (e.g. phrenic nerve infiltration in mesothelioma) or splinting of the diaphragm due to abdominal cause of distension.

*Decreased compliance/increased airways resistance*

- Pulmonary fibrosis.
- Consolidation.
- Tumour.
- Pulmonary oedema.
- Lymphangitis carcinomatosa.
- Exophytic endobronchial tumour.
- Reversible airways obstruction/COPD.

*Psychological*

- Anxiety/fear.

**Management of breathlessness**

- Reversible causes of SOB, as in  Causes of breathlessness in malignant disease, p. 142, should be treated accordingly. Correct the correctable.
- A multidisciplinary approach is helpful, with consideration given to non-pharmacological strategies such as breathing exercises, physiotherapy, relaxation therapy, and massage. Patients should be helped to adjust their expectations.
- Treat pain.
- Non-drug measures—controlled breathing exercises, companionship, reassurance, relaxation, and distraction therapies.
- *Drug palliation to relieve SOB:*
  - *opioids*—decrease respiratory panic and the distressing sensation of SOB. They reduce anxiety and are analgesic. They also decrease the sensitivity of the respiratory centre to raised  $p\text{CO}_2$ , reducing excessive respiratory drive; e.g morphine sulfate 2.5mg/4-hourly PO
  - *benzodiazepines*—are anxiolytic, sedative, and muscle relaxants. Concerns about respiratory depression are usually unfounded, e.g. lorazepam 0.5–2mg PO prn
  - $\text{O}_2$ —can be beneficial for correcting hypoxia. Can also relieve SOB, even when the  $\text{O}_2$  tension is normal, possibly through a cooling effect on the face or as a placebo (similar effect using a fan or a breeze from an open door or window). Beware if the patient has coexisting COPD (no more than 28%  $\text{O}_2$  should be administered).

**Cough**

- Protective reflex for clearing the airways.
- Some drugs exacerbate cough (e.g. ramipril).

*Management*

- Treat the cause, e.g. antibiotics for chest infection.
- Aid expectoration with saline nebulizers, bronchodilators.
- Soothing cough syrup—simple linctus to coat the pharynx, 10–15mL 4-hourly and as required.
- Can be combined with low-dose morphine sulfate solution as a soothing cough suppressant (5mg of morphine sulfate solution with 10–15mL of simple linctus) 2–4-hourly, as required.
- Refer for laser ablation if an endobronchial tumour is the cause of continued large airway irritation/obstruction.

- 1–2% nebulized lidocaine, starting initially at low concentrations of 2–2.5mL mixed with 2–2.5mL of normal saline. NB Remind the patient and carers of the risk of aspiration 1–2h after administration.
- Involvement of the recurrent laryngeal nerve by malignant infiltration within the mediastinum:
  - hoarse voice ± 'bovine' cough (often difficulty in clearing the airway, as cough poorly effective)
  - ENT referral for injection of paralysed vocal cord or thyroplasty procedure, if appropriate.



## Pruritus

- Pruritus or itch is an unpleasant and/or annoying sensation that provokes the urge to scratch.
- Overlap of C-fibre afferent nerve function with pain.

### Causes of pruritus

- Drug reactions, e.g. antibiotics.
- Infestation—lice, scabies.
- Histamine released through mast cell degranulation:
  - dermatitis
  - allergy
  - anaphylaxis
  - opioid.
- Cupitch syndrome (cutaneous pain and itch), often seen in metastatic manifestation of skin metastases in breast cancer *en cuirasse*. Inflammatory mediators, including prostaglandins, sensitize the cutaneous nerve endings.
- Skin cancers or metastatic deposits.
- Cholestatic jaundice.
- Uraemia.
- Opioids (especially via spinal route).
- Haematological.
- Paraneoplastic.

### Management

Skin management first, drugs second:

- moisturizer and skin care for dry skin
- menthol 1% in aqueous cream
- treat infestations
- consider stenting the bile duct in cholestatic jaundice (if appropriate).

### Drug therapies to consider

General points:

- *naltrexone* should not be used if the patient on opioid therapy for pain management
- the majority of causes of itch in malignant disease or during its oncological management will not respond to antihistamines
- *thalidomide* can cause severe, irreversible peripheral neuropathy in long-term use
- *haematological* causes includes lymphoma, iron deficiency anaemia, polycythaemia vera.

### Aetiology and drug therapies to consider

- *Skin causes/allergies/drug reactions*:
  - antihistamines.
- *Opioid-induced itch*:
  - try an alternative opioid
  - ondansetron.

- *Uraemia:*
  - ondansetron
  - naltrexone
  - mirtazapine
  - thalidomide.
- *Cholestatic:*
  - ondansetron
  - naltrexone
  - paroxetine/sertraline
  - danazol.
- *Haematological:*
  - cimetidine
  - mirtazapine.
- *Paraneoplastic:*
  - paroxetine
  - mirtazapine
  - thalidomide.
- *Unknown or other:*
  - paroxetine
  - mirtazapine
  - thalidomide
  - doxepin.

## Lymphoedema

A chronic, progressive, incurable condition characterized by swelling (often non-pitting), and associated with chronic skin changes. It can lead to profound physical and psychological morbidity, often with significant impairment of function. Damage to the lymphatics due to malignant disease or as a consequence of treatment is called 2° lymphoedema:

- tumour infiltration of lymphatics
- surgery damaging lymphatics or excision of lymph nodes during block dissection
- radiotherapy
- failure of lymph drainage, blockage, surgery, or scarring causes an excessive accumulation and stagnation of protein-rich interstitial fluid
- affects most commonly the limbs but can affect any part
- often non-pitting.

### Pathogenesis of lymphoedema

- Stasis of protein-rich tissue fluid.
- Impaired immune function, as fluid neither circulating nor reaching the lymph nodes.
- Impaired macrophage function.
- Protein, debris, and inflammatory factors accumulate.
- Excellent culture medium for bacteria and/or fungi.
- Recurrent infection eventually leads to fibrosis, with irreversible swelling and thickening of the tissues and skin.
- Fibrin deposition within tissues and blood vessels leads to poor perfusion and oxygenation, causing further damage.
- Increasing protein increases osmotic pressure, tending to draw in even more fluid.
- Uninterrupted cycles of recurrent infection can lead to end-stage lymphoedema (elephantiasis).
- *Before embarking upon lymphoedema management, exclude other causes of a swollen limb. It may be appropriate to manage extrinsic venous compression or deep vein thrombosis (DVT) by stenting and/or anticoagulation.*

### Prevention of lymphoedema

- This is the best strategy.
- Patient education and information is vital.
- Referral to a specialist lymphoedema service, if available.
- Massage and exercise techniques.
- Advice on minimizing the risk of infection/trauma, e.g. gardening gloves when gardening, avoiding sunburn.
- Avoid insect bites, if at all possible.
- Avoid venepuncture or BP measurement on the affected limb.
- Plan an exercise programme during air travel.



### Treatment of acute inflammatory episodes

- Early intervention essential.
- Refer to local lymphoedema service regarding local antibiotic protocols (poor tissue penetration in lymphoedema).

The cause of an acute inflammatory episode is often *Streptococcus*, and treatment should be continued for a minimum of 2wk. IV antibiotics are often required, and often long-term prophylaxis is required.

### Management

- Aim to prevent progression by preventing acute inflammatory episodes and containment of the oedema. Left unchecked, there will be continuous, inexorable progression towards limb swelling and skin changes (elephantiasis).
- Lymphorrhoea should be managed promptly with skin care and padded bandaging. Remember increased risk of infection with compromise of skin integrity.
- Prophylactic use of athlete's foot powder or the prompt treatment of fungal infections, as even small breaks in the skin between the toes act as a portal of entry for infection.
- Daily skin care.
- Self-massage and exercise.
- Specialist fitted gradient compression garments.
- Refractory oedema may require pressure bandaging to reshape the limb, before maintenance compression garments can be fitted.
- Meticulous attention to skin care and hygiene of the affected area. Particular attention to between the fingers, toes, and skinfolds, which should be washed and dried thoroughly.
- There is no drug therapy yet available for the treatment of lymphoedema.

## Mouth care

Good oral hygiene is essential for patients who are about to embark upon cancer therapies or those further on in their disease journey who need to keep up their calorie intake and communicate with those around them. Mouth problems can be a cause of significant psychological morbidity and possible social isolation.

### Those at risk

- Frail elderly.
- Terminally ill.
- Undergoing chemo- and/or radiotherapy, especially of head and neck tumours.
- On drugs with anticholinergic side effects.
- Immunosuppressed or immunocompromised patients.
- Those with oropharyngeal pathology.
- Patients with dysphagia.
- Patients with tracheostomies.
- Periodontal disease and/or tooth caries.
- On steroids.
- Bacterial, fungal, or viral infections.

### Aim of therapy

- To clean the teeth, gums, tongue, and oral cavity.
- Treat infections.
- Protect the mucosa.
- Maintain neutral or alkaline pH of oral cavity.
- Encourage maximum from own saliva—protective, cleansing with neutral to alkaline pH and natural buffers to protect the mouth from huge swings in pH, and neutralize the continuous production of bacterial acids.
- Natural saliva is best.
- Aim for clean, moist mouth; nothing beats saliva.

### Cleaning principles

- Meticulous attention to tooth and gum hygiene with sodium bicarbonate or triclosan-containing fluoride toothpaste.
- Removal of debris with simple warm water, saline, or dilute sodium bicarbonate solution.
- Soft baby toothbrush useful to help clear the tongue of coating and debris.
- Daily or twice-daily rinse with chlorhexidine mouthwash.
- Apply water-soluble lubricating jelly or oral balance gel to mouth and lips.
- Angular cheilitis is common and troublesome, and often of fungal or bacterial aetiology. Hydrocortisone creams containing antifungals or antibacterials are helpful.
- Dentures pose a significant risk to the gums for recurrent infection and mechanical trauma. They should be cleaned daily and soaked in Milton solution or chlorhexidine solution overnight.

## Specific treatments

- *Bacterial infections*—as described in ➔ Cleaning principles, p. 150, and use regular chlorhexidine mouthwash. Tetracycline or doxycycline solutions can also be used.
- *Fungal infections*—common cause of sore mouth. Prophylaxis can be with nystatin suspension, but only active on mucosal contact, with no systemic absorption. Heavily coated mouths should be cleaned as described in ➔ Cleaning principles, p. 150, prior to treatment. Systemic alternative fluconazole 50mg od for 7 days. Miconazole (sugar-free oral gel) can be used, instead of nystatin, and can be applied with a soft baby toothbrush to the tongue and oral cavity.
- *Viral infections*—in severe herpetic stomatitis, systemic therapy with aciclovir is indicated. Solitary lesions may be treated locally with aciclovir cream.

## Chemo-radiotherapy mucositis

- Often associated with anthracycline, fluorouracil, and MTX chemotherapy.
- As described in ➔ Cleaning principles, p. 150, prevention through oral hygiene far better than remedial treatment.
- Benzylamine oral rinse has mild local anaesthetic and anti-inflammatory effects. Often stings, if used undiluted.
- For a generally painful mouth, consider mucosal protectants which can be mixed at the bedside with analgesics or anti-inflammatories.
- Raspberry mucilage (obtained as special order from Nova Laboratories) can be combined with dispersible aspirin 75mg and soluble prednisolone tablets to provide a soothing anti-inflammatory mouth rinse.
- Polyvinylpyrrolidone and sodium hyaluronate (Gelclair®) can also be mixed with morphine sulfate solution.
- Single painful aphthous ulcers can be treated with the local application of hydrocortisone muco-adhesive buccal tablets.
- FA rescue for MTX-induced mucositis.
- Palifermin—human keratinocyte growth factor used before and after myeloablative therapy and autologous haemopoietic stem cell support for haematological malignancies.

## The dry mouth

- There are many preparations for the dry mouth, but none are as effective as natural saliva.
- Can anticholinergic drugs be stopped?
- Regular meals and drinks to encourage normal salivary flow.
- Frozen fruit juices stimulate saliva and are pleasant, e.g. fruit pastille lollies.
- Sugar-free chewing gum containing xylitol (antibacterial) is helpful. Low-tack gum for denture wearers.
- Aqueous lubricating jelly or Biotène Oralbalance®.

- Atomized water spray, small ice chips, soda water, and cider mixed 50:50.
- Saliva replacement:
  - Saliva Orthana® (mucin-based) more like real saliva than other cellulose-based products
  - Saliva natura light oral spray containing natural extracts of the *Yerba santa* plant which mimic the mucoprotective and buffering actions of natural salivary glycoproteins
  - Salinum® saliva substitute containing linseed extract and polysaccharide gel-forming substances
- *Pilocarpine hydrochloride* (salivary stimulant) 5mg tds taken at mealtimes. Prophylactic use whilst receiving radiotherapy to head and neck. Continued for 4–6wk, following completion of treatment. NB Contraindicated in uncontrolled asthma and COPD, hepatic and renal impairment, and closed-angle glaucoma.

### Altered taste

#### Cause

- Commonly linked with poor oral hygiene and *Candida* infection.
- Dry mouth lacks saliva as solvent for taste.
- Coated tongue blocks taste buds.
- Number of drugs and chemotherapeutic agents cause altered or reduced taste (dysgeusia or hypogeusia).
- Paraneoplastic phenomenon.

#### Management

- Treat oral candidiasis.
- Mouth care and clean tongue.
- Stimulate saliva production.
- Vitamin and zinc supplements can be helpful.

## Control of psychological distress

Assessment of psychological problems and the provision of psychological support must be an integral part of the package of care for patients with malignant disease. Presentation may be in the form of:

- denial/confusion
- anger
- anxiety
- sadness/depression
- sense of loss
- alienation
- seemingly poor control of physical symptoms
- attention-seeking and manipulative behaviour.

All health care professionals should be aware of the frequency with which psychological problems are overlooked. Time must be set aside for mental state assessment. Cues from the patient or carer should be heeded. Standardized clinical tools to measure the psychological morbidity and QoL may be helpful, e.g.:

- Hospital Anxiety and Depression Scale (HADS)
- Functional Assessment of Cancer Therapy (FACT)
- Functional Living Index–Cancer (FLIC)
- European Organization for Research and Treatment Quality-of-Life Questionnaire (EORTC QLQ-C30).

### Management

- Self-help—patients should be given control over their management and helped to set realistic goals and develop coping strategies.
- Informal support—the sharing of experiences, the ventilation of feelings in a supportive environment, and the exchange of information about the physical, psychological, and social consequences of cancer and its treatment can help to reduce the sense of alienation and isolation sometimes associated with cancer, e.g. Cancer BACUP, Cancerlink, local cancer support groups. Many patients draw spiritual and practical support from their religious community.
- Formal support—access to trained counsellors is often available through 1° care services or hospital-based cancer information centres. Palliative care specialist nurses are also trained in assessing the need for, and offering, psychological support and usually have access to psychologists and/or psychiatrists, if additional help is required.
- Psychological therapies—cognitive behavioural therapy and brief psychotherapeutic interventions can be effective for more significant levels of anxiety or depression.
- Psychiatric interventions—medical staff should be able to recognize when referral to a liaison psychiatrist, and also when drug therapy (antidepressant or anxiolytic), is required. Psychotropic medication benefits around 25% of cancer patients suffering from significant anxiety and depression.

## Symptom control at the end of life

### Assessment

Although death may be imminent, it is important that changes in a patient's mental state are adequately assessed. This is because there may be potentially reversible causes of distress and agitation that the patient may benefit from having specifically addressed. These include:

- inadequate pain control
- urinary retention or the need to have their bowels open
- nausea
- breathlessness
- fear of the unknown and the future, and spiritual issues
- side effects of medication
- unfinished business or family conversations
- dealing with family conflict.

However, symptom assessment at this stage should be achieved with minimal disruption to the patient, in terms of examinations and investigations. The priority is to optimize the patient's physical and psychological comfort and to facilitate a dignified and peaceful death. Remove the medicalized barriers to family communication, such as O<sub>2</sub> masks, bandaged IV infusion canulae, and tubing interfering with the ability to hold a relative's hand.

### Prescribing in the terminal phase

- Discontinue all non-essential medication. In practice, this usually means discontinuing everything, except analgesia, anxiolytics, anticholinergics for respiratory secretions, and possibly anti-emetics. If the patient is unconscious and has entered the terminal phase, it is usually not necessary to continue corticosteroids.
- Avoid the oral route. Continuous s/c infusion via a syringe driver is often the route of choice and does not necessarily require admission, although it will require significant support from the 1° care services or the community palliative care team.
- IV medication should also be avoided, if at all possible. Cannulation is intrusive and painful.
- Adequate prn doses—the ideal is for the s/c infusion to achieve optimal symptom control, without the need for additional doses. It remains essential to ensure that prn doses are available, so that the nursing team has ready access to them, should any signs of distress develop.
- *Opioids*—these should be continued if they have been part of the patient's medication previously, but converted to the equivalent s/c dose (see ↻ Opioid potencies relative to oral morphine and 24h equianalgesic doses of opioids, p. 122). The prn dose should be one-sixth of the total 24h dose. If the patient is opioid-naïve but seems in pain, then a small dose of diamorphine or morphine can be introduced, e.g. 5–10mg s/c over 24h, with 2.5mg s/c available as the prn dose. Review regularly, and titrate as required.
- *Anxiolytics*, e.g. midazolam, starting at 5–10mg s/c over 24h, with 2.5–5mg s/c available as prn dose. This needs frequent review, as often many patients may need significantly greater doses. Occasionally, agitation persists despite escalating midazolam doses.

- Always check for a simple reversible cause of agitation, such as urinary retention, and catheterize, if necessary.
- Levomepromazine can be added for its sedating properties, typically starting with a stat dose of 6.25–12.5mg s/c, adding 12.5–25mg s/c over 24h and titrating as required.
- Haloperidol, e.g. 2.5–5mg s/c, can also be useful for distress.
- *Anti-emetics* are often being co-prescribed with opioids and can be continued as necessary.
- *Respiratory tract secretions*—these are frequently more upsetting for the relatives than for the patient. The conscious patient is more likely to be distressed by the dry mouth that is an inevitable side effect of the pharmacological intervention for respiratory tract secretions. If the patient is unconscious, then simple methods, such as appropriate positioning and gentle suction, may be effective. Anticholinergic agents should usually be reserved for the unconscious, actively dying patient.
- Remember that anticholinergics will reduce the production of subsequent secretions, but the current secretions within the airways will have to dry during respiration or be removed by gentle suctioning.
- *Hyoscine hydrobromide* 400 micrograms s/c stat can be tried or incorporated into the syringe driver (usual dose 0.8–2.4mg over 24h). It crosses the blood–brain barrier, is anti-emetic, causes sedation, and can cause delirium.
- *Hyoscine butylbromide* is also effective (10–20mg prn and 20–120mg s/c over 24h) but does not cross the blood–brain barrier, and so, although it is anti-secretory and anti-spasmodic, it lacks anti-emetic activity nor is it sedating.
- *Glycopyrronium bromide* (200 micrograms s/c stat and 600–1200 micrograms over 24h) again does not cross the blood–brain barrier.
- Side effects of all three relate to their antimuscarinic action.
- *Explanation and communication:*
  - it is essential that the relatives (and the patient, if conscious) understand the aims behind what is being done and what is now past the point of being appropriate
  - the balance between adequate pain control and possible sedation must be explained
  - the relatives should be kept informed of what is happening at every stage when the patient is too unwell to engage in conversation. All goals and aims are explained and will help reduce their inevitable upset and anxiety
  - the contents and purpose of the s/c infusion should be clarified
  - the relatives must be reassured that the needs of the patient will continue to be reviewed and adjustments made accordingly. Time spent at this stage will hopefully help the relatives to understand, and subsequently grieve, without anger, suspicion, or unanswered questions about those final hours.
- Involvement of specialist palliative care services, either hospital- or community-based. Advice on difficult symptoms may be invaluable, as are the additional skills in managing the needs of relatives before, during, and following the patient's death.

## Integrated care pathway

- Increasingly, hospitals are formalizing the care of the dying patient and their family by implementing an integrated care pathway for the use of the MDT.
- This is in accordance with NICE guidelines in England and through the 'Living and Dying Well' Government Initiative in Scotland.
- An example is the now defunct Liverpool care pathway, more recently replaced by the five new Priorities for Care of the Dying Person.
- These pathways aim to provide a framework for addressing aspects of physical, psychological, and spiritual care in the later stages of life and after the patient's death.
- Correct implementation of these pathways requires training of all members of the MDT who may be involved in the care of the dying patient. This should include formal training in the recognition of the dying patient.
- There has been recent and widespread criticism in the media regarding such pathways. Cases highlighted in the press often focus on examples where end of life care has not been managed well.
- Public misconceptions surrounding these pathways, and repeated in the media, include that:
  - they preclude hydration, food, or antibiotics
  - there is no scope for clinical review
  - there is an intention to hasten death.
- Used appropriately, with sufficient investment of time by the whole team, these pathways:
  - could represent best practice for the care of the dying patient.
- In a recent survey, an overwhelming majority of doctors agreed that, if used properly, integrated care pathways offer patients the greatest chance of a dignified death. However, controversy remains, and integrated care pathways have yet to find their place (see ➔ Further reading, p. 156).

## Further reading

- Breen E (2013). Liverpool Care Pathway is a nice idea—pity about the practice. *BMJ* 346, f1837.
- Brooks D, Wee B (2013). The Liverpool care pathway: what is the furore in the press about? *Br J Hosp Med (Lond)* 74, 4–5.
- Chinthapalli K (2013). The Liverpool care pathway: what do specialists think? *BMJ* 346, f1184.
- Dalal S, Bruera E (2013). Access to opioid analgesics and pain relief for patients with cancer. *Nat Rev Clin Oncol* 10(2), 108–16.
- Fearon K, Arends J, Baracos V (2013). Understanding the mechanisms and treatment options in cancer cachexia. *Nat Rev Clin Oncol* 10(2), 90–9.
- National Institute for Health and Care Excellence (2011). Quality standard for end of life care for adults. Available at: <http://www.nice.org.uk/guidance/QS13>.
- Rocque GB, Cleary JF (2013). Palliative care reduces morbidity and mortality in cancer. *Nat Rev Clin Oncol* 10(2), 80–9.
- Waldman E, Wolfe J (2013). Palliative care for children with cancer. *Nat Rev Clin Oncol* 10(2), 100–7.



# Late effects of chemotherapy and radiotherapy

- Introduction 158
- Endocrine and metabolic dysfunction 160
- Fertility issues 162
- Organ-specific problems 164
- Secondary malignancies 167
- Neuropsychological consequences 168
- Further reading 168

## Introduction

- Recent decades have seen significant advances in oncological treatments for many paediatric malignancies and some adult tumours, e.g. germ cell cancer, lymphomas.
- The focus has always been to optimize the chance of a cure.
- For the first time, there are long-term survivors after treatment for advanced malignancy.
- Additionally, adjuvant or neoadjuvant chemotherapy has an expanding role in the management of many resected or potentially resectable solid tumours, e.g. breast, colorectal.
- For those managing curable cancers, the challenge is to maximize the rates of cure, whilst minimizing long-term toxicity from the treatment.
- It is important for the medical profession as a whole to be aware of the potential long-term consequences of treatment for cancer because:
  - studies have shown that a significant proportion of adult survivors of childhood cancers either are unable to confirm their diagnosis of malignancy or misclassify their treatment
  - many possible toxicities have the potential to detract significantly from future QoL, and some may even shorten life expectancy
  - >90% of survivors of paediatric stem cell transplantation have at least one late adverse effect.
- Surveillance for complications of therapy needs to be continued for many decades.



## Endocrine and metabolic dysfunction

### Pituitary dysfunction

- Common after whole brain radiotherapy; >90% become GH-deficient, potentially affecting the bone density, cardiovascular risk, and sense of well-being.
- Adrenocorticotrophic hormone (ACTH) insufficiency (causing adrenal failure), thyroid dysfunction, and gonadal failure can also occur.
- Continued surveillance needed for  $\geq 10$  years.
- Initial investigations:
  - serum GH and insulin-like growth factor-1 (IGF-1)
  - thyroid-stimulating hormone (TSH) and thyroxine ( $T_4$ )
  - ACTH
  - follicle-stimulating hormone (FSH) and testosterone/oestrogen.
- Replacement therapy is an established treatment in children (in the absence of active malignancy) but is more controversial in adults.

### Adrenal failure

- The most common cause of adrenal insufficiency is the suppression of hypothalamic–pituitary–adrenal function by prolonged administration of synthetic glucocorticoids.
- The cortisol-producing parts of the adrenal gland atrophy in the absence of ACTH stimulation.
- Mineralocorticoid production usually remains near normal.
- Recovery is usual, but occasionally adrenal failure is permanent.
- Initial investigation—early-morning cortisol, the Synacthen® test.
- Symptoms are typically non-specific, including chronic malaise and anorexia.
- Presentation with adrenal crisis is rare, but patients may require additional supplementation at times of physiological stress, e.g. sepsis.

### Primary thyroid dysfunction

- Common after total body or cranio-spinal irradiation, or radiotherapy to the neck, e.g. cumulative incidence of ~30% in patients treated for Hodgkin's disease by 20 years post-radiotherapy.
- Subclinical syndrome may persist for years before the development of overt hypothyroidism.
- Typically an insidious-onset multisystem disorder, with symptoms that can include fatigue, weight gain, cold intolerance, constipation, and depression.
- Annual screening with thyroid function tests (TFTs) recommended in high-risk patients.
- Treatment should usually begin once the TSH is elevated, even if  $T_4$  levels are normal, to avoid overstimulating the gland.

## Metabolic syndrome

- Quartet of:
  - insulin resistance
  - dyslipidaemia
  - hypertension
  - abdominal obesity.
- Observed in up to 50% of long-term survivors of childhood bone marrow transplants.
- Potential risk of premature cardio- and cerebrovascular events.
- Metabolic syndrome is itself associated with an increased incidence of several common cancers, including colorectal, endometrial, and postmenopausal breast cancer.
- Long-term monitoring should probably include serum lipids and fasting blood glucose.

## Fertility issues

- Patients should always be alerted to the risk of infertility.
- ~30% treated for childhood cancers become infertile. Treatment in adulthood can also cause infertility.

### Causes of gonadal dysfunction

- *Direct involvement by tumour*—e.g. 5% incidence of contralateral carcinoma *in situ* in testicular tumours.
- *Surgery*—e.g. removal of gonad.
- *Radiotherapy affecting pituitary/gonadal function*—e.g. TBI tends to cause infertility in men and women. Lower doses may produce transient oligospermia in men. Radiotherapy is more damaging to ovarian tissue than chemotherapy—a dose- and age-dependent effect.
- *Chemotherapy*—effects vary greatly, depending on the agent, e.g. high risk of gonadal dysfunction, particularly with alkylating agents (e.g. cyclophosphamide) and cisplatin. In women, the number of maturing follicles appears to decrease the most, whilst primordial follicles can appear unaffected.

### Effects of age

- The older a woman, the more likely treatment is to precipitate the menopause, e.g. adjuvant anthracycline or cyclophosphamide chemotherapy for breast cancer in a 40-year-old → ~70% chance of inducing the menopause, in a 25-year-old → ~10%. This probably represents their greater reserve of oocytes.
- Effects are not consistent; women of a similar age receiving similar treatment may experience very different effects on ovarian function.
- The prepubertal testis seems less susceptible to the effects of chemotherapy than the mature adult testis.

### Effects of gender

- For example, post-chemotherapy containing alkylating agents for Hodgkin's disease—~90% of men are infertile; ~50% of women will have an early menopause but will not necessarily have been infertile.

### Fertility versus sexual function

- Important to differentiate when discussing the risks of treatment with patients.
- Spermatogenesis is more likely to be disrupted than testosterone production, so men may be infertile without loss of libido or erectile function.

### Strategies for preservation of gonadal function

#### Men

- Sperm retrieval techniques:
  - from ejaculated sperm (straightforward to arrange for adults)
  - testicular/epididymal retrieval in combination with intracytoplasmic sperm injection (ICSI) (see ↻ Alternative strategies for fertility preservation, p. 163)

- conception rates using stored sperm are ~30%
- certain diagnoses (e.g. Hodgkin's, testicular cancer) may be associated with abnormal pre-treatment testicular function
- NICE clinical guidelines issued in 2013—sperm cryopreservation should be offered to men and adolescent boys who are preparing for medical treatment for cancer that is likely to make them infertile.

### Women

- *Oophoropexy*—a surgical procedure to move the ovaries beyond a planned radiotherapy field; mixed results only. Probably limited by the effects of scatter radiation or surgically induced alterations in the ovarian blood supply.
- *Ovarian suppression*—gonadotrophin-releasing hormone (GnRH) analogues to reduce ovarian function reversibly during treatment with chemotherapy have little supporting evidence in humans.
- *Storage of ovarian tissue/oocytes*—increasingly available following recent reports of successful pregnancies. Ovarian tissue can be retrieved without the need for ovarian stimulation. Ovarian hyperstimulation following an (o)estrogen receptor (ER)-positive tumour is to be avoided, if at all possible.
- NICE has issued clinical guidelines (applicable in England and Wales) for the management of people with cancer who wish to preserve their fertility. It is worth noting that many of the eligibility criteria for conventional infertility treatment do not apply to patients with a diagnosis of cancer (see ➡ Further reading, p. 168).
- Any decision to delay anti-cancer treatment and to proceed with fertility preservation should take into account:
  - the diagnosis
  - if this is a hormone-sensitive cancer, e.g. ER-positive breast cancer
  - the treatment plan, including its relative urgency
  - the prognosis from the cancer
  - the likely outcome of subsequent fertility treatment.

### Alternative strategies for fertility preservation

- Natural conception—may occur, sometimes unexpectedly. Menstrual function and fertility may return to normal, even years after completing treatment.
- Storage of frozen embryos—possible. Generally requires the woman to have a partner, to delay treatment, and to undergo  $\geq 1$  cycle of *in vitro* fertilization (IVF) (preceded by ovarian hyperstimulation).
- ICSI—a single sperm is injected directly into the cytoplasm of a mature oocyte. Appropriate, particularly if the spermatozoa are limited in number or quality.
- Donor eggs.

## Organ-specific problems

### Cardiac

- Anthracycline exposure (e.g. doxorubicin, epirubicin):
  - most commonly associated with long-term cardiovascular complications, particularly dilated cardiomyopathy
  - risk is dose-dependent—cumulative doses should be calculated (empiric guidelines for maximum lifetime doses: doxorubicin 550mg/m<sup>2</sup>, epirubicin 900mg/m<sup>2</sup>. Local guidelines should be followed, and these figures should not preclude careful clinical monitoring)
  - risk also increases with age, if there is pre-existing cardiac disease, or in the presence of other cardiotoxic therapies, e.g. trastuzumab
  - prior or concurrent radiotherapy has an additive effect. This is significant, because chemotherapy for breast cancer typically includes an anthracycline, and chest wall radiotherapy is also commonly used in this group of patients
  - the effects can be seen many years later
  - evidence suggests that infusional treatment is associated with a lower risk of cardiotoxicity than bolus therapy. In reality, most protocols use bolus doses (no need for long lines, fewer admissions, etc.)
  - monitoring via echocardiography or multigated acquisition (MUGA) scanning is appropriate—abnormal septal movement is usually observed before any decline in ejection fraction
  - initial management is usually with an angiotensin-converting enzyme (ACE) inhibitor and referral to a cardiologist.
- Trastuzumab:
  - monoclonal antibody targeting a specific epitope of the HER2 protein
  - can cause treatment-related cardiomyopathy. This can range from an asymptomatic reduction in left ventricular function to congestive cardiac failure
  - preliminary evidence suggests this cardiotoxicity is reversible
  - regular surveillance echocardiograms are recommended for women receiving treatment.
- Radiotherapy:
  - adjuvant radiotherapy to the thorax is commonly used, particularly in breast cancer and Hodgkin's disease
  - despite improving radiotherapy techniques, cancer survivors treated with radiation still have relatively increased risks of coronary artery disease, congestive heart disease, and sudden cardiac death
  - the effect is additive with some common cytotoxic agents, e.g. anthracyclines.

### Pulmonary

- Bleomycin (e.g. to treat germ cell tumours):
  - can cause pulmonary fibrosis
  - symptoms include dyspnoea, a non-productive cough, and chest pain
  - risk factors include ↑ age, ↑ dose, renal insufficiency (80% of bleomycin is renally excreted), and high doses of inspired O<sub>2</sub> (anaesthetists should be made aware of prior bleomycin therapy)



- treatment with bleomycin should be discontinued immediately when the diagnosis is suspected
- the presentation may be acute or many months after treatment.

### Renal

- Several drugs used in oncology have the potential to cause chronic impairment of renal function, e.g.:
  - cisplatin
  - aminoglycoside antibiotics (frequently used in neutropenic sepsis)
  - NSAIDs.

### Neurological

Oxaliplatin can cause an acute transient neurotoxicity, typically experienced as pain or numbness in the feet and hands, or around the mouth, and frequently exacerbated by cold.

Many chemotherapy drugs can cause a cumulative symmetrical sensory neuropathy which is frequently dose-limiting.

- Examples include:
  - cisplatin (usually at cumulative doses  $>400\text{mg}/\text{m}^2$ ) and oxaliplatin (cumulative dose  $>640\text{mg}/\text{m}^2$ )
  - taxanes
  - vincristine.
- Patients may complain of:
  - intermittent pins and needles
  - numbness in the fingertips or toes
  - discomfort walking ('like walking on cotton wool or cobblestones')
  - difficulty performing fine tasks such as doing up buttons or holding a pen.
- If treatment is continued, the neuropathy may become chronic.
- In some circumstances, temporary cessation of the causative agent may allow recovery of the neuropathy to such an extent that it permits reintroduction of the drug, e.g. intermittent oxaliplatin in colorectal carcinoma.
- Symptoms may continue to worsen, even after ceasing therapy. Recovery can be slow but occurs to some extent in most patients.

### Ears

Several treatments can also damage hearing permanently, typically causing high-frequency sensorineural loss  $\pm$  tinnitus.

Examples include:

- platinum agents
- high-dose radiotherapy
- aminoglycoside antibiotics.

### Eyes

- Cataracts can be a consequence of radiotherapy or the use of high-dose steroids.
  - Radiotherapy-induced Sjögren's syndrome is a recognized phenomenon.

**Skeletal**

- Treatment-related reduction in bone mineral density is being increasingly recognized as a significant long-term complication.
- Induction of premature menopause will also put the patient at risk of osteoporosis. Vitamin D and calcium supplements can minimize bone loss. At-risk patients should have bone densitometry and consideration of bisphosphonate therapy.
- Prolonged use of exogenous steroids can also cause osteopenia.

## Secondary malignancies

- Risk factors for the development of 2° malignancies include:
  - specific treatments previously received, e.g. alkylating agents, topo II inhibitors, radiotherapy
  - ↑ inherent genetic risks, e.g. predisposing genetic polymorphisms, *BRCA1/2* carrier
  - field changes, due to carcinogen exposure, e.g. cigarette smoking and risk of lung, head and neck, or urothelial cancers
  - other persisting environmental factors such as smoking.
- 5–10% of all childhood cancer survivors develop second malignancies.
- The peak incidence of 2° myeloid malignancies occurs 2–10 years after treatment. Prognosis is poor.
- 2° solid malignancies typically occur 10–20 years after treatment for the 1° diagnosis.
- Radiation-induced tumours have a particularly long latency, sometimes occurring several decades after treatment. Therefore, despite increasingly refined radiotherapy techniques, there is already a large cohort of patients with a lifelong elevated risk of second malignancies.
- The risk of a testicular cancer survivor treated with radiotherapy developing a second solid malignancy is reported to be 2–3 times the rate in the general population. The incidence of leukaemia is also greater in those patients treated with etoposide-containing chemotherapy regimes.
- Successful treatment for Hodgkin's disease is associated with an increased incidence of leukaemias, NHL, and solid tumours, e.g. lung, breast, and thyroid cancers. A UK screening programme for breast cancer has been introduced for women previously treated with mantle radiotherapy for Hodgkin's disease.

## Neuropsychological consequences

The long-term neuropsychological sequelae of the treatment for cancer cannot be underestimated.

### Problems related to specific treatments

- Cranial irradiation in a young child is associated with:
  - impairment in short-term memory, attention span, and information processing
  - often preservation of verbal IQ; therefore, the child may give the appearance of coping well.
- Cognitive dysfunction, following adjuvant chemotherapy for breast cancer, has been extensively studied. Although some studies have suggested an association (particularly with high-dose adjuvant chemotherapy), this has not yet been conclusively proven.

### Problems related to the process of treatment

Cancer therapies are often intensive, debilitating, and protracted. Survivors may experience:

- social isolation—time away from work or school
- problems integrating back into the peer group
- difficulties accepting alterations in appearance or ability
- psychological consequences of adapting to long-term effects, e.g. changes in sexual function and employability
- practical consequences that may impact on the QoL, e.g. difficulty in arranging life insurance or taking out a mortgage.

## Further reading

- Avensu-Coker L, Bauman D, Lindheim SR, Breech L (2012). Fertility preservation in pediatric, adolescent and young adult female cancer patients. *Pediatr Endocrinol Rev* 10, 174–87.
- Blijdorp K, van Waas M, van der Lely AJ, Pieters R, van den Heuvel-Eibrink M, Neggers S (2013). Endocrine sequelae and metabolic syndrome in adult long-term survivors of childhood acute myeloid leukaemia. *Leuk Res* 37, 367–71.
- Blumenfeld Z (2012). Chemotherapy and fertility. *Best Pract Res Clin Obstet Gynaecol* 26, 379–90.
- Braunstein S, Nakamura JL (2013). Radiotherapy-induced malignancies: review of clinical features, pathobiology, and evolving approaches for mitigating risk. *Front Oncol* 3, 73.
- Jaworski C, Mariani JA, Wheeler G, Kaye DM (2013). Cardiac complications of thoracic irradiation. *J Am Coll Cardiol* 61, 2319–28.
- Jesudas R, Malesky A, Chu R, Fischer H, Kamat D (2013). Reviewing the follow-up of pediatric patients' status post-hematopoietic stem cell transplantation for the primary care physician. *Clin Pediatr (Phila)* 52, 487–95.
- Kucharska W, Negrusz-Kawecka M, Gromkowska M (2013). Cardiotoxicity of oncological treatments in children. *Adv Clin Exp Med* 21, 281–8.
- National Institute for Health and Care Excellence (2013). Fertility: assessment and treatment for people with fertility problems. Available at: <https://www.nice.org.uk/guidance/cg156>.

# Hormone therapy

Introduction 170

Types of endocrine therapy 172

Predictors of response 175

Resistance to hormone therapy 176

Controversies 177

## Introduction

Hormones have been implicated in the aetiology and growth of many malignant tumours (including vaginal, ovarian, thyroid, pancreatic, and GI cancers, melanomas, and meningiomas). The best evidence that hormones promote the growth of cancers relates to sex steroid hormones and cancers of their target organs, namely oestrogens and progestins in breast and endometrial cancers and androgens in prostatic cancer. In general, the aim of hormone therapy for cancer is to deplete the circulating level of the hormone promoting tumour growth or to block binding of the hormone to its receptors within the tumour cell. Both can result in tumour regression in response to reduction of hormone-dependent tumour cell proliferation and induction of cell death (apoptosis).

### Principles of hormone therapy for cancer

- Either remove or reduce the hormone driving cell proliferation or block binding of the hormone to the cell receptor.
- Results in the inhibition of cell proliferation and/or programmed cell death.

The effects of endocrine therapy are generally confined to normal target organs for the hormone, and there are few side effects outside these organs. This accounts for the tolerability of these treatments in comparison with cytotoxic chemotherapy. In addition, tumour responses to hormone therapy may be durable, even in advanced disease. However, some cancers arising in hormone-dependent organs are resistant to endocrine therapy, either at presentation or on relapse, and become increasingly unresponsive during the course of treatment and disease progression. Thus, most patients with metastatic breast cancer die with hormone-independent disease.

### Hormone-responsive cancers

- Sex hormones:
  - breast, prostate, endometrial cancers.
- Renal cancer, meningioma.
- Peptide hormones:
  - thyroid and neuroendocrine cancers, carcinoid tumours.



## Types of endocrine therapy

### Ablation of endocrine glands

In men and pre-menopausal women, the major sites of sex hormone synthesis are the gonads. Castration decreases circulating testosterone in ♂ by over 95% and oestrogens in pre-menopausal women by 60% (relative to follicular phase levels). These endocrine effects produce clinical benefits in about 80% of men with metastatic prostate cancer and in 30–40% of unselected pre-menopausal women with advanced breast cancer. Oophorectomy is not beneficial in post-menopausal women, because the post-menopausal ovary produces relatively little oestrogen.

Hypophysectomy and adrenalectomy have been used in post-menopausal women with advanced breast cancer, the adrenal being one source of post-menopausal oestrogen. These produce benefit in about one-third of cases, but the procedures have significant morbidity and lack specificity, removing other classes of hormones, in addition to the sex steroids. The irreversible nature of surgical ablation of endocrine organs, when all patients cannot be guaranteed benefit, has provided the impetus to develop alternative pharmacological therapies that are specific, reversible, and self-limiting. Thus, if therapy proves ineffective, drug withdrawal allows hormone levels to return to normal, with amelioration of side effects.

### Agonists/supraphysiological doses of hormone

The gonadotrophins luteinizing hormone (LH) and FSH provide the stimulus for gonads to produce steroid hormones; in turn, their synthesis and release from the pituitary are regulated by the hypothalamic factor GnRH (or LH-releasing hormone, LHRH). Highly potent agonist analogues of GnRH have been synthesized by introducing incorrect amino acids into the native peptide. When administered for short periods, they cause a rapid release of gonadotrophins, but, in the long term, these agonists downregulate and desensitize the pituitary receptors. As a result, circulating gonadotrophins fall, the trophic drive to the gonads is abolished, and circulating sex hormones are reduced to castration levels. Depot formulations of LHRH agonists are available, so that a single injection can maintain effective medical castration over prolonged periods. The use of GnRH analogues in pre-menopausal women with breast cancer and men with prostate cancer has produced anti-tumour effects equivalent to surgical castration.

A similar mechanism of action underpins the response seen in hormone-dependent cancers, following the use of pharmacological doses of steroid hormones such as:

- oestrogen (diethylstilbestrol)
- progestogens (medroxyprogesterone and megestrol)
- androgens.

Lower physiological doses of the same hormones may accelerate tumour growth.

Whilst the downregulation of steroid hormone receptors occurs in target organs, other non-specific effects can occur, and these agents may be associated with, e.g. thromboembolic disease. Also, tumour flare may occur at the start of treatment. Despite this, they are of clinical benefit, e.g. high-dose progestogens for advanced endometrial and breast cancers.



## Inhibition of steroid-producing enzymes

This approach is illustrated by inhibitors of aromatase activity. The aromatase enzyme converts androgens to oestrogens, and this is the last step of the synthetic cascade. It is the main source of oestrogen in post-menopausal women. Its inhibition represents the most specific method of blocking oestrogen production. Because oestrogen biosynthesis can occur in non-endocrine tissue, such as adipose tissue, and malignant tumours themselves (particularly in post-menopausal women), aromatase inhibitors have the potential to suppress oestrogen levels beyond that achievable by adrenalectomy.

Two major types of aromatase inhibitors have been developed:

- *steroidal or type I inhibitors*—interfere with the attachment of the androgen substrate to the catalytic site
- *non-steroidal type II inhibitors*—interfere with the enzyme's cytochrome P450.

Early type II inhibitors, such as amino-glutethimide, were neither potent nor specific, inhibiting other steroid-metabolizing enzymes that had a similar cytochrome P450 prosthetic group, so that steroid replacement therapy was required. The current generation of triazole drugs (anastrozole, letrozole) are 2000-fold more potent than amino-glutethimide and have differential affinity towards aromatase cytochrome P450, with highly selective inhibition of oestrogen biosynthesis. These drugs can reduce circulating oestrogens in post-menopausal women to undetectable levels, without influencing other steroid hormones.

Among type I inhibitors, exemestane is thought to act as a 'suicide' inhibitor, blocking aromatase irreversibly through their own metabolism into active intermediates by the enzyme; oestrogen biosynthesis can only be resumed when aromatase molecules are synthesized *de novo*.

Similarly, the conversion of adrenal steroid precursors to androgens is catalysed by the enzyme cytochrome P450 17A1 (CYP17A1). This enzyme is expressed in the gonads, but also in other tissues, including the prostate. Inhibition of CYP17A1 by abiraterone results in a significant reduction in androgen levels in castrate-resistant prostate cancer. The most common adverse events, which were associated with increased mineralocorticoid levels, included hypokalaemia, fluid retention, and hypertension; these events were largely reduced by co-administering low-dose prednisolone.

## Steroid hormone antagonists

These agents block hormone-mediated effects usually at the level of their receptors. Antagonists for oestrogens, progestins, and androgens have been developed. The most extensive experience relates to the use of the anti-oestrogen tamoxifen in the treatment of breast cancer. Tamoxifen binds to the ER and blocks the effects of endogenous oestrogens. Responses are more likely to occur in tumours that are ER-positive.

Tamoxifen incompletely blocks the trophic actions of oestrogen and can demonstrate partial agonist activity, especially when endogenous oestrogens are low. This explains its positive effects protecting against osteoporosis, but also unwanted stimulation of endometrial proliferation, which can give rise to polyps and rarely endometrial cancer. More potent 'pure' anti-oestrogens have therefore been developed, such as fulvestrant, which

completely blocks the transcriptional activity of the ER. This drug produces clinical responses in some patients with breast cancer who are resistant to tamoxifen.

Anti-androgens, such as flutamide and bicalutamide, have clinical efficacy in the treatment of prostatic cancer. Anti-progestins, such as RU-486 and onapristone, have been used against breast and endometrial cancers.

### **Single-agent versus combination hormone therapy**

In the same way that combination chemotherapy has proved superior to single-agent therapy in many cancers, combined hormone treatments might be predicted to produce improved response rates. In fact, for most hormone combinations, toxicity is increased, with no improvement in treatment outcome. However, there are exceptions to this rule.

### **Steroid sex hormone therapy treatment options**

- Castration (surgical or medical).
- Synthetic pathway blockade (e.g. aromatase inhibition).
- Steroid receptor blockade.
- Combination therapy.

#### *Breast cancer*

- Castration plus tamoxifen is superior to either alone in advanced pre-menopausal disease.
- Tamoxifen plus aromatase inhibitor is of no benefit over aromatase inhibitor alone in advanced disease or adjuvant therapy.
- Sequential substitution of one hormone treatment by another can result in second and third responses when the previous treatment has failed in advanced disease.

#### *Prostate cancer*

- Castration plus anti-androgen blockade has failed to produce clear benefits, compared with castration alone.
- Sequential addition of anti-androgen to castration can result in second response when the disease is progressing post-castration.
- Castration-resistant prostate cancer is frequently still dependent on the activation of the androgen receptor, as demonstrated by the clinical efficacy of the CYP17 inhibitor abiraterone. This drug inhibits androgen synthesis from adrenal precursors.

## Predictors of response

Given that hormone therapy is not effective in all tumours, the indiscriminate application of treatment exposes patients with resistant cancer to the side effects of endocrine deprivation therapy and delays other potentially beneficial treatment such as chemotherapy.

Currently, no biomarker correlates absolutely with the response to endocrine therapy. For breast cancer, the most widely used predictor is the ER. Between 60% and 75% of breast cancers are ER-positive by biochemical assay or immunohistochemistry (IHC); two-thirds of ER-positive advanced breast cancers respond to hormone manipulation, compared with <10% of ER-negative tumours. The highest response rates are in tumours expressing both ER and progesterone receptors (PRs), and the majority of ER-negative responding cancers are PR-positive.

The value of other markers, such as the PR in endometrial cancer, is less clear, and measurement of the androgen receptor in prostatic cancer has not proven useful.

Previous response to hormone manipulation and disease-free interval are useful clinical predictors for response to second-line endocrine therapy. Although progression on one hormone therapy does imply relative resistance to further endocrine manipulation, response rates to second- and third-line therapy fall progressively (for advanced breast cancer to 30–40% second-line, 20–30% third-line).

## Resistance to hormone therapy

Resistance to hormone therapy may be 1°, i.e. no response to the initial hormone therapy, or acquired, i.e. the disease progresses during treatment after the initial response. Several possible mechanisms are listed.

### Primary resistance

- Mutation has resulted in hormone-independent proliferation in the tumour with, or without, loss of the hormone receptor.
- A hormone-dependent pathway is present but unresponsive to treatment, e.g. mutated receptor.
- Hormone-independent stimulation of pathway, e.g. 'cross-talk' from other growth factor receptors (there is good laboratory evidence of EGFR and ER cross-talk in breast cancer).

### Acquired resistance

- Clonal selection of the above pathways.
- Increased production of the hormone receptor or hormone.
- Increased affinity of the receptor for the hormone.
- Altered hormone–receptor interaction, responds to hormone antagonists as agonists (clinical evidence comes from observed responses to the withdrawal of tamoxifen in advanced breast cancer and withdrawal of anti-androgens in advanced prostate cancer).
- Induction of metabolic enzymes, reducing intracellular levels of the hormone antagonist.

## Controversies

### Duration of adjuvant therapy

If hormone deprivation therapy is not cytotoxic, but cytostatic, therapy would need to be given indefinitely. The counter-argument is that resistance may be accompanied by a change in the tumour phenotype induced by the continued presence of the drug. Discontinuation of the first adjuvant treatment, followed by another non-cross-resistant regime, might be more effective. Such approaches have been explored in ER-positive early breast cancer, with tamoxifen and aromatase inhibitors. Although switching from tamoxifen to an aromatase inhibitor after 2–3 years of adjuvant tamoxifen has been shown to reduce the risk of recurrence of breast cancer, compared with 5 years of adjuvant tamoxifen alone, it remains uncertain how this approach compares with 5 or more years of aromatase inhibitor only, in terms of both cancer recurrence and late toxicities, e.g. osteoporosis.

### Chemo-endocrine therapy

If endocrine therapy is an effective systemic treatment and combination chemotherapy is beneficial, there is good reason to use chemo-endocrine therapy. However, hormone therapy, by suppressing tumour cell growth, may give protection from chemotherapeutic agents that are most effective against replicating cells. This has been demonstrated to be clinically relevant in the adjuvant therapy of breast cancer. In general, these treatment modalities are best given sequentially, rather than concurrently, with endocrine therapy started after completion of chemotherapy.



# Targeted and biological therapies

Introduction	180
Small molecule inhibitors	182
Monoclonal antibodies	188
Active immunotherapy	190
Adoptive immunotherapy	194
Tumour vaccines	195
Further reading	196

## Introduction

- Conventional chemotherapies are limited by their non-specific toxic effects on normal tissues, particularly those that are rapidly proliferating.
- A greater understanding of the molecular differences between normal tissue and tumour cells allows targeting of these differences.
- The ideal goal is to develop strategies of anti-neoplastic treatment which:
  - specifically kill malignant cells
  - do not induce tumour resistance
  - minimize the damage to the rest of the body
  - can be given over long periods as 'maintenance therapy'.
- It is a testament to recent advances in oncology that this chapter has become increasingly streamlined. Several of the agents introduced in previous editions are now established amongst standard treatment regimes and can be found in the relevant specialty chapters.
- NICE guidance is included, where appropriate, but the reader is advised to consult current guidelines via the website ( <http://www.nice.org.uk/guidance>), as targeted and biological therapies are increasingly being recommended. Some treatments remain restricted to the context of clinical trials.
- The number of potential targets which have been identified for anti-cancer treatments is expanding rapidly. Part of this expansion is driven by the need to overcome the development of tumour resistance.
- A comprehensive review of these is beyond the scope of this handbook. Our aim is to:
  - outline some of the principles of targeted and biological therapies
  - introduce some of the more commonly used agents
  - direct the reader to the appropriate specialty chapter where the therapies can be placed in their clinical context
  - identify appropriate further reading, with particular emphasis on the most common cancers.





## Small molecule inhibitors

An increased understanding of the mechanisms of signal transduction and intracellular signal amplification in tumour cells has led to the identification of key families of proteins with critical roles in cell division and cell death.

### Tyrosine kinase inhibitors

Tyrosine kinases (TKs) can be divided into:

- receptor TKs (RTKs):
  - e.g. epidermal growth factor (EGF)
    - Her2/neu receptors
  - family of cell surface receptors
  - the activity of these receptors controls intracellular signal transduction, cellular proliferation, apoptosis, etc.
  - the physiological binding to the extracellular domain of the receptor activates the intracellular TK domain, initiating a cascade of downstream events.
- non-receptor TKs:
  - e.g. c-ABL
  - found at intracellular locations, e.g. in the cytosol
  - mutation and aberrant function of these also have a role in oncogenesis, e.g. see ➔ Chronic myeloid leukaemia, p. 558.

Genes encoding TKs are usually under tight inhibitory control. However, in many malignancies, it is known that this control is lost. This may result in:

- upregulation:
  - e.g. ~30% of breast cancers overexpress the RTK Her2/neu (as described in ➔ Monoclonal antibodies, p. 188; see also Chapter 14).
- constitutive activation of the TK domain:
  - e.g. BCR-ABL, the non-receptor fusion TK observed in CML (see ➔ Management, p. 559).

Much interest has focused on mechanisms of inhibiting TKs.

#### Direct inhibition by small molecule tyrosine kinase inhibitors

- Molecules with specific activity, for example:
  - erlotinib inhibits EGFR (see ➔ Inhibition of the epidermal growth factor receptor pathway, p. 184)
  - lapatinib specifically inhibits the Her2/neu and EGFR pathways (see ➔ Inhibition of the Her2/neu and epidermal growth factor receptor pathways, p. 184) and has a proven role in progressive metastatic breast cancer in patients previously treated with trastuzumab.
- Broad-spectrum inhibition of several pathways:
  - e.g. sunitinib—a TKI whose multiple targets include KIT, platelet-derived growth factor (PDGF), and vascular endothelial growth factor (VEGF) (see ➔ Inhibition of the vascular endothelial growth factor pathway, p. 185).

*Indirect inhibition of the tyrosine kinase signalling cascade by antibody binding to the receptor or ligand cascade*

- See ➔ Monoclonal antibodies, p. 188.

The aim is to produce treatments with greater specificity for malignant cells, in the hope of minimizing toxicity to normal tissue.

The spectrum of side effects observed with TKIs includes effects probably due to the inhibition of TK activity in normal tissues, e.g.:

- acneiform rash after erlotinib and cetuximab
- cardiomyopathy after trastuzumab.

## Small molecule inhibitors of tyrosine kinases

### Imatinib

- Orally administered, specific Abl TKI.
- Common side effects include:
  - oedema/effusions
  - nausea
  - diarrhoea
  - rashes
  - myelosuppression.

### Role of imatinib in chronic myeloid leukaemia

- Approved for use as first-line treatment in patients with CML (see ➔ Chronic myeloid leukaemia, p. 558).

### Role of imatinib in mucosal melanoma

- ~20% of patients with mucosal melanoma have a mutation in c-kit. There is therefore a mechanistic rationale for anticipating clinical benefit from the targeted inhibition of KIT, but its use remains within the context of clinical trials at present (see Chapter 23).

### Role of imatinib in the treatment of gastrointestinal stromal tumours

- >80% of GI stromal tumours (GISTs) have a mutation in the KIT proto-oncogene, leading to the constitutive activation of the c-kit RTK (see Chapter 25). The remainder usually possesses a mutation in a related RTK, e.g. PDGF receptor (PDGFR).
- Imatinib is active against the mutant TK isoforms.
- Mutation testing may allow the selection of patients likely to benefit from imatinib or requiring higher-dose imatinib or an alternative TKI, and hence improve the targeting of treatment.
- Metastatic or unresectable disease:
  - early trials suggest it is a well-tolerated treatment, with radiological response rates of ~50%, and 2-year survival rates of >70%, in a group of patients for whom there previously was no therapeutic option
  - despite the high response rates, complete responses are rare (<10%), and most patients eventually become resistant to therapy, probably via the acquisition of additional KIT mutations. The median time to progression (TTP) is around 2.5 years
  - approved by NICE for the treatment of patients with KIT-positive GIST tumours that either are unresectable or have metastasized
  - continuous treatment is recommended, with reassessment of response every 12wk.
- Adjuvant treatment:
  - a large (~600 patients) randomized phase III trial reported that treatment with imatinib, following the resection of a GIST, is associated with significantly fewer instances of disease relapse (3% versus 27%)—the trial was halted prematurely, and patients in the placebo arm were offered treatment with imatinib

- however, the long-term impact on OS is not known, and adjuvant imatinib is not currently standard therapy in the management of resected GIST tumours (the last guidance from NICE in 2012 did not recommend imatinib as adjuvant treatment in people after surgical removal of a GIST).

### *Inhibition of the epidermal growth factor receptor pathway*

#### *Gefitinib*

- A small molecule TKI, which specifically targets the EGFR TK domain.
- Orally administered and generally well tolerated.
- Early-phase trials in NSCLC (see Chapter 13) were particularly encouraging and prompted larger phase III studies, with variable results. It has now been recommended by NICE (2010) as first-line treatment of patients with locally advanced or metastatic NSCLC in specific circumstances only, which must include a positive test for the EGFR TK mutation.
- Studied in many other solid cancers, with ongoing clinical trials in various tumour types.

#### *Erlotinib*

- Another orally available selective inhibitor of the EGFR TK.
- Studied in many solid tumours, with some encouraging results, in particular in:
  - NSCLC—recommended by NICE (2012) as first-line treatment of patients with locally advanced or metastatic NSCLC in specific circumstances only, which must include a positive test for the EGFR TK mutation (see Chapter 13)
  - Pancreatic cancer—licensed in combination with gemcitabine, but its use is generally limited to within the context of clinical trials (see Chapter 17).
- The most significant side effects are:
  - diarrhoea
  - diffuse, often distressing, acneiform rash.
- The optimal molecular marker to predict response to treatment is not yet established:
  - upregulation of EGFR (either protein overexpression or gene amplification) is predictive of response to treatment, as are specific activating mutations in the TK domain of the EGFR.
- KRAS mutations are associated with resistance.

### *Inhibition of the Her2/neu and epidermal growth factor receptor pathways*

#### *Lapatinib*

- An orally administered small molecule TKI, which dually targets the intracellular domains of both human EGFR-1 and -2 (HER2).
- As with treatment with trastuzumab (see  Trastuzumab (Herceptin®), p. 188), HER2 testing is mandatory prior to the initiation of treatment with lapatinib—it should only be administered to patients whose tumours overexpress HER2 or demonstrate HER2 gene amplification.
- Currently limited to use in women with HER2-positive metastatic breast cancer who fulfil certain limited clinical criteria (see Chapter 14) or within the context of clinical trials.

- The most clinically significant side effects are:
  - cardiac toxicity (see ↻ Monoclonal antibodies, p. 188)
  - diarrhoea.

### *Inhibition of the vascular endothelial growth factor pathway*

#### *Sunitinib*

- An orally administered, multi-targeted small molecule kinase inhibitor which inhibits the VEGF receptor TK, as well as other closely related TKs associated with the PDGFR and the *c-kit* oncogene.
- The effect is to inhibit both:
  - the proliferation of tumour cells
  - the development of tumour blood vessels.
- Licensed for single-agent use in advanced RCC and approved for first-line use in the UK in patients with advanced/metastatic RCC in certain circumstances (NICE guidance, 2009) (see Chapter 19). Also has a role in the management of GIST tumours which have developed resistance to imatinib (see Chapter 25).
- The most significant side effects are:
  - fatigue
  - diarrhoea
  - loss of appetite
  - skin toxicity
  - hypertension.

#### *Sorafenib*

- Orally administered, multi-targeted small molecule kinase inhibitor which inhibits multiple kinases, including those associated with the PDGFR and fibroblast growth factor receptor-1. Also inhibits C-raf and B-raf (see Fig. 23.5) and blocks the intracellular domain of the VEGF receptor.
- Clinical roles in metastatic hepatocellular cancer (see Chapter 17) and RCC (see Chapter 19).
- The most significant side effects are:
  - diarrhoea
  - hand-foot syndrome
  - hypertension
  - cardiac toxicity.

### *Mammalian target of rapamycin inhibition*

#### *Temsirolimus*

- An IV administered analogue of rapamycin which acts as a cell cycle inhibitor via competitive inhibition of the mammalian target of rapamycin (mTOR) kinase.
- mTOR kinase is the mammalian target of rapamycin and plays a critical role in several transduction pathways necessary for:
  - cell cycle progression
  - cellular proliferation.
- Clinical role in metastatic renal cell cancer (see Chapter 19). Also licensed in relapsed/refractory mantle cell lymphoma.
- Most significant side effects include:
  - rash
  - anaemia
  - poor appetite.

*Inhibition of the mitogen-activated protein kinase signalling pathway**Vemurafenib*

- A potent, orally administered inhibitor of the mutant BRAF.
- Clinical application in patients with malignant melanoma, whose tumours possess an activating mutation in the *BRAF* gene (see Chapter 23 and Fig. 23.5).
- The most significant side effects include:
  - rashes/photosensitivity
  - second skin cancers
  - QTc prolongation.



## Monoclonal antibodies

- The development of hybridoma technology and the resulting tumour-associated mAbs offers new prospects for strategies of targeted biological therapies.
- Some of the applications of mAbs in oncology are in diagnosis:
  - e.g. IHC
  - radio-immunodetection.
- There is now convincing evidence to support the use of specific mAbs in the therapy of solid malignancies.
- These new biological response-modifying agents can be added to chemotherapy regimes and have been shown to improve results.
- They have entered the mainstream in terms of management options in breast, gastric/gastro-oesophageal junction (GOJ), ovarian, and colorectal cancer.

### Trastuzumab

- An IV administered humanized mAb that binds to the HER2/neu protein, a cell surface growth factor receptor, discussed earlier (see ↻ Tyrosine kinase inhibitors, p. 182).
- Binding to the HER2/neu protein inhibits signal transduction, hence inhibiting cellular growth and reducing malignant potential.
- HER2 testing is essential prior to initiation of treatment—Herceptin® should only be administered to patients whose tumours overexpress HER2 or demonstrate *HER2* gene amplification. This is confirmed by either of the following test results:
  - strong IHC staining (3+) for the gene product
  - fluorescence *in situ* hybridization (FISH) analysis confirming gene amplification (usually requested if IHC 2+).
- Trastuzumab is generally well tolerated and does not appear to increase most side effects of standard chemotherapy.
- The most significant toxicity is asymptomatic left ventricular dysfunction (in up to 15%), with the risk of progression to clinically significant cardiomyopathy (~4%). Routine echocardiograms are suggested in patients commencing treatment or those on long-term maintenance, particularly if pre-treated with anthracyclines.
- Established clinical roles:
  - in combination with adjuvant chemotherapy in HER2-positive early breast cancer (see Chapter 14).
  - in patients with metastatic HER2-positive breast cancer (see Chapter 14)
  - with palliative chemotherapy in patients with HER2-positive metastatic gastric/GOJ cancer (see Chapter 17)
- The expression rates in the 1° tumour were generally believed to represent the expression rates in subsequent metastases. However, discordance has been reported in up to 20% of cases (of 1° versus subsequent metastatic breast cancer), and retesting on relapse should be considered.



## Cetuximab

- A human/mouse chimeric mAb, administered IV, that binds to the EGFR, causing inhibition of the EGFR signalling pathway.
- Adverse effects of treatment with cetuximab include:
  - hypersensitivity reactions (~3%)
  - acneiform rash (possibly due to high levels of EGFR expression in the basal layer of the epidermis).
- Established clinical roles in:
  - EGFR-expressing, KRAS wild-type metastatic colorectal cancer (see Chapter 17)
  - locally advanced, recurrent or metastatic SCC of the head and neck (see Chapter 21).
- Use in other tumours remains within the context of clinical trials, e.g. NSCLC.
- The mechanism of action of cetuximab has not been fully elucidated. There is no correlation between the intensity of EGFR staining and the clinical response to treatment.
- Its effects are likely dependent on an intact downstream signalling pathway. For instance, if the downstream *KRAS* gene is also mutated (causing an uncontrolled activation of the pathway). then upstream binding to the EGFR may be ineffectual. *KRAS* and *BRAF* mutations are known to be associated with a low response rate to cetuximab, hence the requirement to verify that the tumour is *KRAS* wild-type before commencing cetuximab in patients with metastatic colorectal cancer.

## Bevacizumab

- An IV administered mAb targeting VEGF, a growth factor implicated in cellular proliferation and the 1° factor controlling angiogenesis.
- Its established clinical roles include:
  - metastatic colorectal cancer (see Chapter 17)
  - metastatic breast cancer (see Chapter 14)
  - advanced NSCLC (unless predominantly squamous cell) (see Chapter 13)
  - epithelial ovarian, Fallopian tube, or 1° peritoneal cancer (first-line or on recurrence) (see Chapter 20)
  - metastatic RCC (see Chapter 19).
- The most clinically serious side effects include:
  - GI perforation, delayed wound healing, fistula formation
  - infections, including febrile neutropenia
  - thrombosis (arterial and venous)
  - haemorrhage.
- Other common side effects include:
  - peripheral neuropathy
  - nausea and vomiting
  - diarrhoea.

## Active immunotherapy

- The immunization of the patient with materials that elicit an immune reaction capable of eliminating/delaying tumour growth.
- It includes the administration of non-specific stimulators of the immune system. Two examples are described in this section.

### Bacillus Calmette–Guérin

- The anti-neoplastic effect of the live attenuated form of *Mycobacterium bovis*—bacillus Calmette–Guérin (BCG)—was reported by Pearl in 1929. Subsequently, Mathe and co-workers suggested a survival benefit in animals with haematological malignancies treated with BCG.
- The immunotherapeutic action of BCG includes the activation of macrophages, T- and B-lymphocytes, and NK cells. It induces local type II immunological responses via interleukins (IL-4, IL-1, IL-10). Bacterial surface glycoproteins attach to epithelial cells and act as antigens.
- Clinical studies that followed did not confirm any effectiveness of systemic BCG administration in patients with various malignancies (lymphocytic leukaemia, melanoma, lung cancer).
- Currently, there are only two applications of BCG in cancer patients.

#### *Intravesical instillation of BCG for the treatment of patients with superficial bladder cancer*

- The most effective intravesical agent for the prophylaxis of Ta and T1 superficial bladder cancer, with a 38% reduction of recurrence rate.
- Only approved intravesical treatment for carcinoma *in situ* (CIS), with an average complete response rate of 72% (versus <50% for chemotherapy).
- The exact mechanism of anti-tumour action is unclear, although multiple local inflammatory effects have been documented.
- Side effects of treatment include dysuria, haematuria, mild fever, urinary frequency, and rarely sepsis.



#### *Intralesional injection into cutaneous melanoma metastases*

- Observed association between BCG vaccination in early childhood and a lower incidence of malignant melanoma in later life.
- Multiple clinical trials examining adjuvant BCG in early-stage melanoma, or oral BCG and intralesional BCG in s/c melanoma deposits.
- Mixed results—but objective response to intralesional BCG appears most likely in patients with solely cutaneous metastases.
- Rarely used in clinical practice.

### Cytokines

- Soluble proteins that mediate the interactions between the cells and their extracellular environment, in both an autocrine and paracrine manner.
- Exert their biological effect in a wide range of tissues, but mainly on cells of haemopoietic and immune lineage.
- A given cytokine can both promote and inhibit tumour growth. How the cytokine will act depends on its concentration, the type of the tumour, and factors relating to the stage of disease.
- Several cytokines promise to be of therapeutic importance in oncology:

### Interferons

- Family of proteins produced by the immune system in response to viral infection.
- Antiviral, antimicrobial, antiproliferative, and immunomodulatory activity.
- Anti-tumour effects include direct cytostatic activity, modulation of oncogene expression, and enhancement of the cytotoxic activity of NK cells, macrophages, and T-cells.
- Interferon alfa (IFN- $\alpha$ ):
  - *hairy cell leukaemia*—previously, this was the treatment of choice, with a 90% response rate in the peripheral blood and 40% normalization of the bone marrow, now replaced by purine analogues
  - *CML*—previous role as first line in the management of CML (now replaced by imatinib; see  Management, p. 559) was based on studies reporting 50–75% haematological remission rates. Monotherapy increases the median survival from 3 to 5 years, whilst its combination with other treatment modalities increases the response rate further
  - *RCC*—partial response rates of 10–20% were seen, with the typical duration of response being 6–8 months; now replaced by targeted therapy against the VEGF receptor.
  - *malignant melanoma*—monotherapy has moderate anti-tumour activity, but, when combined with chemotherapy (e.g. dacarbazine), response rates are as high as 20%. A potential role in the adjuvant treatment of early-stage melanoma remains to be clarified but may be clinically valuable in selected high-risk patients.
  - *carcinoid tumours*—see  Adjuvant/neoadjuvant therapy, p. 334.
- Interferon beta and interferon gamma:
  - not in routine clinical use, although both are also believed to exert some anti-tumour effect.
- Side effects of the IFNs include ‘flu-like’ symptoms (>90%), anorexia, fatigue,  $\uparrow$  liver function tests (LFTs), myelosuppression, and depression (>15%).

### Interleukins

- IL-2:
  - a lymphokine produced by activated T-cells, which enhances the proliferation of lymphoid cells and the migration of lymphocytes from the peripheral blood
  - anti-tumour activity includes the capacity to lyse fresh tumour cells, the regression of distant metastases in murine models, and the *in vivo* release of other members of the cytokine family
  - *RCC*—systemic administration of high doses of IL-2, alone or in combination with lymphokine-activated killer (LAK) cells, activated *ex vivo*, can induce a durable partial, or even complete, response in a minority (~10%) of patients with metastatic RCC. It has never been demonstrated in a randomized controlled trial (RCT) that IL-2 results in improved OS
  - *metastatic melanoma*—a similar low response rate (<15%); synergy with concomitant dacarbazine has been reported

- Interferon alfa enhances IL-2 lymphocyte proliferation, and IFN- $\alpha$ /IL-2 combination therapy is undergoing clinical assessment in patients with RCC and melanoma.
- Toxicity is dose-dependent and includes 'flu-like' symptoms, drowsiness, and anaemia. More serious adverse events, including neuropsychiatric disturbances, capillary leak syndrome, severe  $\downarrow$  BP, and arrhythmias, are also common (toxic fatalities in up to 10% of patients).

#### *Tumour necrosis factor*

- An important mediator of the inflammatory response—involved in stress conditions, cachexia, and endotoxin shock.
- Mainly produced by monocytes, activated macrophages, and T-cells.
- Induces the expression of major histocompatibility complex (MHC) classes I and II antigens, as well as adhesion molecules responsible for leucocyte migration and accumulation.
- Clinical trials in several malignancies, mostly in patients with advanced melanoma and sarcoma. Disappointing, with poor response rates <5%.
- Systemic administration is limited by toxicity, including acute fever,  $\uparrow$  LFTs, CNS toxicity (including encephalopathy), and impaired renal function.
- Loco-regional administration (intraperitoneally, intravesically, intralesionally) seemed more promising and led to trials of TNF- $\alpha$  administered via isolated limb perfusion (in combination with melphalan and interferon gamma  $\pm$  hyperthermia) in patients with recurrent sarcoma and in-transit melanoma. Prospective randomized trials failed to support the initial encouraging retrospective data.

#### *Erythropoietin (recombinant human)*

- A haemopoietic cytokine, usually administered s/c.
- Evidence from many randomized double-blind, placebo-controlled trials supports its use in patients with anaemia and (non-myeloid) cancer-related fatigue.
- Improvements in haemoglobin (Hb) (to  $\geq 12\text{g/dL}$ ) correlate with improvements in QoL parameters, independently of the chemotherapy regime and tumour response. Transfusion requirements fall.
- Generally well tolerated; side effects include injection site pain and hypertension.
- Conflicting evidence exists in patients receiving curative radiotherapy for head and neck SCC—erythropoietin (EPO) treatment has been associated with poorer loco-regional progression-free survival (PFS), although methodological issues make these data difficult to interpret.

#### *Granulocyte colony-stimulating factor*

- A cytokine secreted mainly by macrophages, monocytes, endothelial cells, and fibroblasts.
- Promotes myelopoiesis—the 1 $^{\circ}$  target cells appear to be late myeloid progenitors.
- Also affects the function and lifespan of mature neutrophils.
- G-CSF s/c administration shortens the period of neutropenia, following myelosuppressive chemotherapy. In potentially curable malignancies, e.g. germ cell tumours, childhood malignancies, acute leukaemia, adjuvant

treatment of breast cancer, dose reduction or delay in chemotherapy due to neutropenia is to be avoided. Treatment with G-CSF can support neutrophil production on the days subsequent to chemotherapy when the bone marrow is most affected.

- Current European guidelines recommend 1° prophylaxis with s/c G-CSF, if the risk of febrile neutropenia associated with the regime is  $\geq 20\%$ .
- 2° prophylaxis, following an episode of febrile neutropenia, is also appropriate as an alternative to dose reduction.
- Use during established febrile neutropenia has been examined in several studies. No consistent correlation between a reduction in the duration of neutropenia and clinical benefit (mortality from infection or improvement in OS) has been demonstrated.
- Clearer role in some treatments for haematological malignancies, including patients undergoing haemopoietic stem cell transplantation.
- Side effects—bone pain is the most common (up to 30%) but can usually be managed with simple analgesia.
- In most other adult oncology patients in the UK receiving chemotherapy with palliative intent, chemotherapy dose reduction is the preferred option, following an episode of neutropenia.

## Adoptive immunotherapy

The cell-mediated immune response is crucial in the rejection of allogeneic and syngeneic tumours.

This prompted the use of cells with anti-tumour activity in patients with malignancies—an approach known as *adoptive immunotherapy*.

Several strategies have been applied to generate cells with reactivity to tumours. These include:

- the production of LAK cells:
  - incubate human peripheral blood lymphocytes with IL-2 to produce cells that can lyse fresh tumour cells
  - the exact mechanism of recognition and destruction of tumours by LAK cells is not fully understood
  - work in animal models initially suggested that the benefit of IL-2 was maximized by the addition of LAK cells. However, subsequent clinical trials in patients with metastatic RCC and melanoma failed to reveal any therapeutic advantage in the addition of LAK cells, compared to IL-2 monotherapy.
- isolation of tumour-infiltrating lymphocytes (TILs):
  - isolated from human tumours
  - can recognize tumour-associated antigens
  - these have been administered to patients with advanced melanoma, in combination with IL-2. Response rates of 25–35% have been reported, including in some patients previously treated with IL-2
  - a resource-consuming treatment modality, and it is unlikely that any clinical benefit will outweigh the use of IL-2 alone.

## Tumour vaccines

### Virally induced tumours

- HBV vaccine is a widely used and effective vaccine against HCC.
- Studies are in progress to develop vaccines against EBV, which is closely linked to the development of BL, NHL, and nasopharyngeal carcinoma.
- The National Health Service (NHS) now offers a vaccination programme against HPV, strains 16 and 18, which are responsible for 70% of cervical cancer (see Chapter 1). The programme will initially target girls aged 12–13 years (commencing 2008), with plans for a 'catch-up' programme to include older teenage girls, commencing shortly afterwards.

### Non-virally induced tumours

- The concept of a vaccine for a non-virally induced tumour is more complex. The theory is that tumour cells, or tumour cell extracts, are used as cancer vaccines, intending to enhance a humoral or cell-mediated immune response (i.e. B- or T-cell-mediated) to relevant tumour-specific antigens, rather than to induce prophylactic immunity.
- The antibodies produced may kill the tumour cells by complement fixation or antibody-dependent cellular cytotoxicity, whilst the activation of cytotoxic T-cells that recognize antigens on the tumour cell surface may induce specific cytolysis.
- Immunization strategies rely on the efficient presentation of tumour antigens on either the MHC class I or II molecules of specialized antigen-presenting cells such as dendritic cells. Unfortunately, it is believed that many neoplastic cells employ tactics that minimize their risk of immune recognition, e.g. loss or downregulation of MHC class I molecules. Co-administration of appropriate epitopes with dendritic cells may be one method of optimizing antigen presentation, to maximize the T-cell response.
- Several vaccines for melanoma, colorectal, breast, prostate, and lung cancers are currently under clinical evaluation. Preliminary data support the concept that active immunization will be effective for patients with high-risk recurrent disease, after surgical removal of the tumour, when the tumour burden is small.
- Most clinical trials, to date, have been in patients with advanced, extensive disease, refractory to conventional therapies, who are probably already immunosuppressed.

## Further reading

- Jelovac D, Emens LA (2013). HER2-directed therapy for metastatic breast cancer. *Oncology (Williston Park)* **27**, 166–75.
- Mihaly Z, Sztupinszki Z, Surowiak P, Gyorffy B (2012). A comprehensive overview of targeted therapy in metastatic renal cell carcinoma. *Curr Cancer Drug Targets* **12**, 857–72.
- National Institute for Health and Care Excellence. For regular NICE guidance and updates, see <http://www.nice.org.uk/guidance>.
- Noguchi T, Ritter G, Nishikawa H (2013). Antibody-based therapy in colorectal cancer. *Immunotherapy* **5**, 533–45.
- Ohashi K, Maruvka YE, Michor F, Pao W (2013). Epidermal growth factor receptor tyrosine kinase inhibitor-resistant disease. *J Clin Oncol* **31**, 1070–80.
- Zigler M, Shir A, Levitzki A (2013). Targeted cancer immunotherapy. *Curr Opin Pharmacol* **13**, 504–10.



## Part 3

# Clinical trials, cancer prevention, and screening

10	Clinical trials	199
11	Cancer prevention	203
12	Population screening for cancer	217



# Clinical trials

Methodology in cancer 200

Quality of life 202

## Methodology in cancer

### Introduction

Clinical trials can be classified as:

- phase I studies
- phase II studies
- phase III studies.

In addition, some phase III studies are sometimes referred to as phase IV or post-marketing studies.

No study should be started without a protocol that describes in detail:

- the aim of the study
- the patient eligibility criteria
- the screening and follow-up studies
- the treatment
- the criteria to score toxicity and activity.

In addition, rules for informed consent procedures should be specified. Trials of any sort should have approval by a properly constituted ethics committee.

All of these criteria have been specified in guidelines produced by the International Conference for Harmonisation for Good Clinical Practice (ICH-GCP). They are also now embedded in European Union (EU) legislation on the conduct of all trials of new therapeutics.

### Phase I studies

Phase I studies are human toxicology studies. Their endpoint is *safety*, and they usually include 15–30 patients. They are designed to define a feasible dose for further studies. These studies begin at a dose that is expected to be safe in humans. Dose escalation is usually between cohorts, and infrequently in individual patients. It can be:

- according to the Fibonacci method (the dose is escalated in decreasing percentages of the previous dose, i.e. 100%, 66%, 50%, 33%, 25%)
- according to pharmacokinetics (pharmacokinetically guided dose escalation, PGDE), using a method that combines statistics with the experience and expectations regarding side effects (continuous reassessment method)
- variation on these methods.

The aim of the phase I study is to describe the side effects that limit further dose escalation (dose-limiting toxicities, DLTs) and to recommend a dose for further studies with the drug or the new administration method (maximal tolerated dose, MTD).

### Phase II studies

In phase II studies, the anti-tumour activity of a new drug or method is the endpoint. There are various statistical designs, including 14–60 patients on average. With the emergence of drugs that create tumour dormancy, rather than cell kill, the endpoint of time to progression becomes important. This is the time from the start of treatment, until the the first evidence of tumour progression. In addition, phase II studies can provide information on side effects related to cumulative drug dose.

### Phase III studies

Phase III studies have either the time to progression or the survival time as the 1° endpoint. Phase III studies always include randomization against a standard form of therapy, or no treatment when no standard therapy exists. 2° endpoints, such as toxicity, pharmaco-economics, and quality of life, are often included. Phase III trials can involve between 50 and several thousands of patients. The number of patients is dependent on the size of the difference expected/clinically important. Cancer trials have often been criticized in the past for being too small to find realistic differences between therapies. Breast cancer studies involving many thousands of patients have been able to define the long-term benefits of hormone therapy and paved the way for larger-scale trials in other common tumours. In the modern era, many large-scale cancer trials are performed, so that the true level of benefit of a new approach can be proven and to allow for the regulatory approval of new agents.

## Quality of life

### Introduction

Most cancer treatments produce unwanted toxicities that interfere with the patient's quality of life. In many cancers, the benefits of new treatments over existing approaches have been modest. As new cancer treatments are developed, a common problem is the comparison of a novel intensive treatment regimen against a relatively less toxic standard. In such circumstances, if the survival gain from the new treatment is reliably established, but of modest magnitude, then it may be questioned whether the gain is worthwhile for individual patients. In weighing up the risks and benefits of all treatments, it is important to consider many aspects such as:

- the duration of treatment
- the length of hospital stay
- the number of clinic visits
- the short- and long-term toxicities
- the less clinical aspects (perhaps less well appreciated), summarized as QoL.

### Assessing health-related quality of life

Several questionnaires for completion by patients have been developed. The European Organisation for Research and Treatment of Cancer (EORTC) Quality of Life Study Group has developed a core questionnaire—the EORTC QLQ-C30—to which are added disease-specific modules. A patient who scores high for global health status/QoL is deemed to have high QoL.

### Difficulties in quality of life assessment

- Compliance declines, as the patient becomes terminal.
- Compliance may also be poor if the patient feels well.
- Can a surrogate, relative, nurse, or physician fill in the form?

There are important challenges in reporting QoL outcomes in clinical trials. These include the description of compliance, summarizing longitudinal data in a complete, yet clinically meaningful, way, balancing the multiple endpoints under consideration and, perhaps most importantly, relating the findings with regard to QoL to other treatment outcomes such as patient survival and treatment-related toxicity.

Attempts have been made to integrate QoL and survival data into quality-adjusted life years (QALYs). The duration of survival is adjusted according to periods of different levels of QoL before summing, to give the OS time for analysis. The final QALY can then be used for a comparison between treatments, embracing both survival effects and changes in QoL.

## Further reading

Eisenhauer EA, Therasse P, Bogaerts J, et al. (2009). New response evaluation criteria in solid tumours: revised RECIST guideline (version 1.1). *Eur J Cancer* 45, 228–47.

# Cancer prevention

- Prevention strategies: introduction 204
- Cancer: genetic and environmental risks 205
- Smoking-related cancers 206
- Cancer prevention: diet 208
- Clinical trials of cancer prevention 210
- Cancer chemoprevention 212
- The role of surgery in cancer prevention 214
- Further reading 216

## Prevention strategies: introduction

Chemoprevention is the use of chemical agents or dietary compounds to reduce the incidence of cancer. The chemical compounds could be trace elements, hormones, or other medicaments; the dietary compounds could be fibre, nutrients, vitamins, etc. This field of medical oncology brings together the disciplines of:

- epidemiology
- carcinogenesis
- toxicology
- pharmacology
- molecular biology
- genetics.

Burkitt observed that colorectal cancer was almost unknown in numerous tribes in Africa, possibly due to their high-fibre diet. Similarly, a number of studies associated breast cancer with obesity, and numerous studies have subsequently attempted to explore the relationship between fat in the diet and the onset of breast cancer.

There are numerous other risk factors for breast cancer, including many that have an endocrine basis:

- delayed puberty
- history of nulliparity
- lack of breast feeding
- contraceptive pill in early life
- hormone replacement therapy (HRT) around the menopause.

Manipulation of the risk of breast cancer through endocrine therapy is therefore a tempting therapeutic target.

Biochemical alterations have been shown in population studies of the blood of cancer patients. Low levels of retinoids, such as vitamin A and carotene, and elements, like selenium, have been associated with cancer, again providing hypotheses to support cancer prevention trials.

Having understood the cancer process and the predisposing factors, it is easier to identify which patient group might be at highest risk of specific cancers and might benefit most from an intervention such as a change of diet or the addition of a medication.



## Cancer: genetic and environmental risks

### Genetic risks

Patients with certain genetic defects are more likely to get cancer—either they have overexpressed oncogenes, such as *K-ras*, or a mutated tumour suppressor gene such as *p53* or *Rb*.

### Environmental risks

- A number of environmental factors are known to cause pre-malignant lesions, e.g. chewing tobacco frequently causes leucoplakia, which may progress to oral cancer.
- Smoking and lung cancer—cigarette smoking remains the most important avoidable environmental carcinogen worldwide (see ↻ Smoking-related cancers, p. 206).
- Viruses have been incriminated in the aetiology of:
  - hepatoma (hepatitis viruses)
  - BL (EBV)
  - nasopharyngeal carcinoma (EBV)
  - cervical carcinoma (HPV 16).
- Vaccines are available against each of these agents. Vaccination against hepatitis B is commonplace in the West and in the UK; vaccination of schoolchildren against the papilloma virus for cervical cancer began in 2008.
- *Helicobacter pylori* has been linked to gastric carcinoma, and early claims of eradication of the organism by antibiotics and subsequent protection from cancer are being validated.
- The association of UV light with skin cancer is well established, as is the increase of malignant melanoma in the UK (~10% per annum).

Overall, it is considered about 50% of all new cancer cases and cancer deaths worldwide are preventable. In developing countries, the most important preventable risk factors are smoking (30%), poor diet, obesity, and lack of exercise (combined) (30%).

## Smoking-related cancers

- Tobacco smoke contains upwards of 4000 chemicals, and, of these, about 55 are known to be carcinogens. These agents cause DNA gene mutations. Nicotine per se does not cause cancer but causes the addiction to tobacco, and hence the exposure to the carcinogens.
- Tobacco use causes 30% of all deaths in the Western world, and an estimated 10 million deaths each year worldwide.
- Smoking causes about 90% of lung cancers, with a clear dose–response relationship between the risk of developing cancer and cigarette consumption.
- Passive smoking is now well recognized to be a danger and a cause of smoking-related cancers.
- ♂ lung cancer deaths have now decreased, whereas, in ♀, lung cancer deaths are increasing, and this reflects smoking patterns.
- Smoking is the major cause of cancers of the larynx, mouth, tongue, pharynx, oesophagus, and lung. Smoking is also a factor in the development of cancer of the pancreas, kidney, stomach, colon, bladder, and cervix.
- In an effort to stop exposure to passive smoking, many countries have banned smoking in workplaces, restaurants, bars, and other public areas. Smoking in such public areas has been banned in the UK since 2007.



## Cancer prevention: diet

This is a controversial area with conflicting data in the literature. Dietary modifications are difficult to promote in populations.

### Dietary fat

Dietary fat promotes tumour growth in animal models, and conversely energy restriction appears to reduce the incidence of tumours.

Excess dietary fat is associated with cancer of the breast, colon, endometrium, and prostate. Dietary studies are fraught with methodological problems, but nonetheless there are increasing case control and cohort studies to point towards an association of excess fat in the diet with breast and colon cancer, in particular. The data showing the relationship between a high-fat diet and prostate cancer are conflicting.

### Dietary fibre

Diets with increased fibre tend to reduce colonic transit time and bind some potentially carcinogenic chemicals.

RCTs of dietary manipulation are extremely difficult and are dogged by poor compliance.

In over a dozen case studies, a meta-analysis indicates an inverse relationship between fibre intake and colon cancer. These are mostly retrospective studies. Prospective studies have produced conflicting data, in particular, the huge Nurses' Health Study.

- There is no evidence that increasing fibre in the diet inhibits the development of colorectal adenomas.
- Evidence that increased fibre in the diet inhibits the development of colorectal cancer is uncertain, and data are conflicting.
- Similarly, whilst high-fibre diets may reduce the risk of breast and stomach cancers, the data are unclear.

### Fruit and vegetable consumption

Again, data are conflicting, and the Nurses' Health Study revealed no association between the consumption of fruit and vegetables during over 1.5 million person years of follow-up.

- Some studies have found an inverse association between fruit and vegetable consumption and stomach cancer, but again data are conflicting.
- There appears to be little association between fruit and vegetable consumption and breast cancer.
- High consumption of fruit and vegetables may be protective for men and women, who have never smoked, in the development of lung cancer.

### Folate

- Folate may reduce carcinogenesis through DNA repair and DNA methylation.
- In animals, folate deficiency increases intestinal carcinogenesis.
- A diet rich in folate may lower the risk of colorectal cancer and the precursor adenoma.
- Several studies have shown that folate supplementation can decrease colorectal cancer risk.

### Carotenoids

These are antioxidants and promote cell differentiation.  $\beta$ -carotene has been investigated, and the data are conflicting.

In some cancers, early data are encouraging (aspirin in colorectal cancer prevention), whereas, in lung cancer, vitamin supplementation has no proven role.

## Clinical trials of cancer prevention

The rules in prevention trials in normal people are very different from classical cancer therapeutic trials. During the trials of tamoxifen given as an adjuvant therapy in early breast cancer, it was observed that the incidence of a second 1° breast cancer in the contralateral breast was lower in women treated with tamoxifen, compared with those treated with placebo. This led to the hypothesis that tamoxifen might be a cancer-preventive agent, as well as a cancer therapy. There followed a series of trials leading to the landmark publication of the Breast Cancer Prevention Trial (BCPT) from the US in 1998, which showed that tamoxifen could halve the number of breast cancers observed in normal women at high risk. However, in two further trials, in different patient populations, no proven benefit in terms of survival was observed. The role of tamoxifen in the prevention of breast cancer in high-risk individuals is not clear, and the British view, until recently, is that the side effects of venous thrombosis/embolism and the risk of endometrial cancer outweigh the benefits. However, a recent review in the *Lancet* (April 2013) of meta-analyses has suggested that chemoprevention may be of benefit. Careful weighing up of risks versus benefits is required. NICE guidance on this controversial area permits the use of tamoxifen in this context.

Whilst tamoxifen and raloxifene decrease breast cancer incidence, there is no overall effect on survival. Such trials have highlighted problems inherent in chemoprevention studies.

- Which healthy individuals should be invited to participate in such trials?
- How should these individuals be identified/contacted?
- When should the drug be started, and for how long continued?
- Side effects that are quite acceptable in cancer patients may be unacceptable in healthy subjects.

### Phase I/II clinical trials

The main objective of early clinical trials of chemopreventive agents is to establish tolerability and side effects of candidate compounds. One major difference from conventional cytotoxic agents is that the duration of administration of the preventive agent will be much longer than for a cytotoxic, so chronic side effects are at least as important as acute side effects. For phase I studies:

- a major side effect would include either fatality, or problems requiring intervention by a physician, or long-term disability. Major side effects would automatically rule out any further development of a chemopreventive agent
- minor side effects may preclude chronic dosing with the agent. The route of administration is usually oral.

A phase II trial will frequently be of longer duration and may have >1 dose level. It may be randomized with a placebo control to clarify toxicities.

- A crucial component in the assessment of the agent at this stage is compliance, which may require pharmacokinetic confirmation.
- The duration may be 1–5 years, and the sample size could be anything from 100 to >1000 volunteers or potential patients.

- The use of surrogate endpoints is extremely important for cost-efficient studies, although there are few biomarkers that are of proven value (e.g. the development of CIS or other precancerous lesion).
- Ease of recruitment is important, because 'high risk' may be clear to a physician, but not so clear to a normal individual.

### Phase III clinical trials

Randomized placebo-controlled phase III studies of chemopreventive agents need to be large and lengthy. As it is costly, in terms of time and resources, to test each new agent with the classical phase III design, two solutions are being tested. One is the concentration on high-risk groups of individuals, and the other is the development of intermediate biomarkers.

The Euroscan trial investigated people who had been cured of one smoking-related cancer in the lung, head, or neck. Second cancers are known to occur in at least 15% of these patients.

- The 1° endpoint was the appearance of a second smoking-related cancer, genotypically different from the first, anywhere in the aerodigestive tract.
- 'Ex-patients' were randomized to receive retinol or acetylcysteine.
- Retinol induces differentiation and inhibits malignant transformation in preclinical models.
- Acetylcysteine has been used widely in chronic bronchitis and works in a totally different way from retinol. It is a potent antioxidant and increases intracellular glutathione. It has been shown in laboratory animals to be an anti-carcinogen.
- In order to test the possible benefits in combining chemopreventive agents, the third arm of the Euroscan trial received both agents, and the fourth arm neither.
- This allows two questions to be answered with half the number of patients.
- Nonetheless, the study requires 2500 individuals to be randomized.

### Summary

Chemoprevention is in its infancy. New methodologies are being evaluated, and new surrogate endpoints and novel candidate interventions are emerging rapidly from the revolution in molecular biology and genetics. It is an extremely promising and exciting branch of oncology.

## Cancer chemoprevention

### Principles of chemoprevention

Many human cancers are preventable, because their causes have been identified in the human environment. Minimization of exposure towards carcinogens in the environment (1° prevention) is an effective strategy in cancer prevention, e.g. smoking avoidance or cessation. However, most environmental factors that initiate or promote cancer remain to be identified, and, once identified, the avoidance of such factors may necessitate difficult lifestyle changes.

Epidemiological data suggesting that cancer is preventable by intervention with chemicals are based on:

- time trends in cancer incidence and mortality
- geographic variations and effect of migration
- the identification of specific causative factors
- a lack of simple patterns of genetic inheritance for the majority of human cancers.

### Chemopreventive agents

Epithelial carcinogenesis proceeds via multiple discernible steps of molecular and cellular alterations, culminating in invasive neoplasms. These events can be separated into three distinct phases:

- *initiation* which is rapid; involves direct carcinogenic damage to DNA, and the resulting mutation is irreversible
- *promotion* follows initiation and is generally reversible; involves the clonal expansion of initiated cells induced by agents acting as mitogens for the initiated cell
- *progression* results from promotion in the sense that cell proliferation caused by promoters allows cellular damage inflicted by initiation to be further propagated.

During tumour progression, genotypically and phenotypically altered cells gradually emerge. Both promotion and progression phases are prolonged. Depending on which phase of carcinogenesis they affect, chemopreventive agents can be divided into tumour-‘blocking’ agents, which interfere with cancer initiation, and tumour-‘suppressing’ agents, which inhibit promotion or progression (see Table 11.1). Blocking agents, such as oltipraz, that prevent the metabolic activation of carcinogens or their subsequent binding to DNA probably reduce the accumulation of initiating mutations.

Altered states of cell and tissue differentiation are characteristic of pre-malignant lesions, long before they become invasive. It may be possible to reverse abnormal differentiation with a hormone-like non-toxic agent. Two other approaches to the control of pre-neoplastic lesions are to block their expansion with non-toxic agents that suppress cell replication, or to induce an apoptotic state in these cells.

Although, in the past, cancer chemopreventive agents have been discovered serendipitously or developed empirically, recent advances in the understanding of the molecular biology of carcinogenesis offer hope for a more rational drug design.



**Table 11.1** Mechanisms of tumour suppression and examples of cancer chemopreventive agents

Mechanism	Examples
Scavenging O <sub>2</sub> radicals	Polyphenols (curcumin, genistein), selenium, tocopherol (vitamin E)
Inhibition of arachidonic acid metabolism	Acetylcysteine, NSAIDs (sulindac, aspirin), polyphenols, tamoxifen
Modulation of signal transduction	NSAIDs, retinoids, tamoxifen, genistein, curcumin
Modulation of hormonal/growth factor activity	NSAIDs, retinoids, curcumin, tamoxifen
Inhibition of oncogene activity	Genistein, NSAIDs, monoterpenes (D-limonene, perillyl alcohol)
Inhibition of polyamine metabolism	2-difluoromethylornithine, retinoids, tamoxifen
Induction of terminal differentiation	Calcium, retinoids, vitamin D <sub>3</sub>
Induction of apoptosis	Genistein, curcumin, retinoids, tamoxifen

NSAIDs, non-steroidal anti-inflammatory drugs.

## The role of surgery in cancer prevention

The rationale behind prophylactic surgery is to prevent the development of cancer in selected patients deemed to be at high risk. A number of scenarios exist, in which prophylactic surgical resection is advocated:

- *MEN type II or familial medullary cell thyroid carcinoma*—prophylactic total thyroidectomy is recommended, preferably in childhood, due to the well-documented time-related progression through dysplasia to carcinoma. There is debate as to whether a prophylactic central neck dissection is also indicated in this situation, with some suggesting routine lymphadenectomy and parathyroid preservation/autotransplantation. The American Thyroid Association recommends surgery to be carried out at <1 years of age for those with MEN type IIB, and <5 years for MEN type IIA and familial thyroid cancer
- *Barrett's oesophagus*—as foci of invasive adenocarcinoma are identified in 30–40% of patients with high-grade dysplasia, prophylactic oesophageal resection is indicated in such patients. Recent evidence has suggested that local therapies, such as RFA, may play a role in selected patients, such as the elderly, to avoid the morbidity of major surgery
- *hereditary diffuse gastric cancer (HDGC)*—associated with a defect in the cadherin-1 (*CDH1*) gene. Individuals at risk are considered candidates for total gastrectomy
- *ulcerative colitis*—patients with long-standing (>10 years) total colitis, in whom high-grade dysplasia is identified, should be considered candidates for proctocolectomy, with or without an ileoanal pouch. For patients with lesser degrees of dysplasia, frequent colonoscopy with biopsy is advised
- *hereditary colorectal cancer*—up to 30% of colorectal cancers have evidence of a familial component, and 5% are due to well-characterized mutations:
  - FAP—following the diagnosis of this condition (with >100 adenomas), treatment options include proctocolectomy with an ileoanal pouch or subtotal colectomy with ileorectal anastomosis and endoscopic surveillance of the rectum
  - HNPCC—accounts for 5% of all colorectal cancers. There is currently no consensus regarding surgery, and most units use colonoscopic surveillance, with colectomy advocated for those exhibiting high-grade dysplasia, a villous growth pattern, or if not resectable endoscopically
- *hereditary breast cancer*:
  - 5–10% of patients with hereditary breast carcinoma carry the *BRCA1* or *BRCA2* genes, and these individuals have a lifetime risk of 80–90% of getting breast cancer. Patients with *BRCA* mutations and a documented moderate or high risk of cancer may opt for bilateral mastectomy ( $\pm$  breast reconstruction), which is associated with a 95% reduction in cancer risk
  - *Cowden syndrome*—this is an autosomal dominant disorder with predisposition to breast and endometrial cancers, and follicular carcinoma of the thyroid. Breast cancer is seen in 25–50% of cases, and prophylactic mastectomy is considered

- *hereditary ovarian cancer*:
  - oophorectomy is considered in women who carry a mutation in *BRCA1* or *BRCA2* genes. The lifetime risk lies between 60% and 85%, and, after counselling, some of these women will opt for laparoscopic prophylactic oophorectomy. This reduces the risk of ovarian cancer by 97%, and breast cancer by 50%. It is recommended by 40 years of age, following appropriate family planning
  - There is increasing evidence that patients with HNPCC may benefit from prophylactic hysterectomy and oophorectomy
- *intraductal papillary mucinous neoplasms (IPMNs)*—pancreatic resection is now considered desirable in patients with IPMNs affecting the main pancreatic duct because of a high prevalence of carcinomas/high-grade dysplasia (70%)
- *porcelain gall bladder*—cholecystectomy is advocated in patients with porcelain gall bladders and also in patients with polyps of  $\geq 10$ mm in diameter
- *maldescended testis*—patients with maldescended testes have a higher chance of developing testicular cancer of  $>20$  times the general population:
  - 10% of testicular tumours arise from undescended testes
  - orchidopexy is generally recommended within the first year or two of life. However, this does not abolish the risk of developing future testicular cancer
  - it is generally agreed that, in the post-pubertal boy, a non-palpable undescended testicle should be excised.

## Further reading

- Benamouzig R, Chaussade S (2004). Calcium supplementation for preventing colorectal cancer—where do we stand? *Lancet* **364**, 1197–9.
- Berek JS, Chalas E, Edelson M, et al. (2010). Prophylactic and risk-reducing bilateral salpingo-oophorectomy: recommendations based on risk of ovarian cancer. *Obstet Gynecol* **116**, 733–43.
- British Society of Gastroenterology (2005). Guidelines for the diagnosis and management of Barrett's columnar-lined oesophagus. A report of the Working Party of the British Society of Gastroenterology. Available at: [http://www.bsg.org.uk/pdf\\_word\\_docs/Barretts\\_Oes.pdf](http://www.bsg.org.uk/pdf_word_docs/Barretts_Oes.pdf).
- Chan A (2007). Can aspirin prevent colorectal cancer? *Lancet* **369**, 1577–8.
- Cuzick J, Sestak I, Bonanni B, et al.; SERM Chemoprevention of Breast Cancer Overview Group (2013). Selective oestrogen receptor modulators in prevention of breast cancer: an updated meta-analysis of individual participant data. *Lancet* **381**, 1827–34.
- Doll R, Peto R, Boreham J, Sutherland I (2004). Mortality in relation to smoking: 50 years observations on male British doctors. *BMJ* **328**, 1519–28.
- Euhus DM, Robinson L (2013). Genetic predisposition syndromes and their management. *Surg Clin North Am* **93**, 341–62.
- Fisher B, Constantino JP, Wickerham DL, et al. (1998). Tamoxifen for prevention of breast cancer—report of NSABP-1 study. *J Int Cancer Inst* **90**, 1371–88.
- Fountoulakis A, Zafirellis KD, Dolan K, Dexter SP, Martin IG, Sue-Ling HM (2004). Effect of surveillance of Barrett's oesophagus on the clinical outcome of oesophageal cancer. *Br J Surg* **91**, 997–1003.
- Hartmann LC, Scharo DJ, Woods JE, et al. (1999). Efficacy of bilateral prophylactic mastectomy in women with a family history of breast cancer. *N Engl J Med* **340**, 77–84.
- Holmes MD, Stampfer MJ, Colditz GA, Rosner B, Hunter DJ, Willett WC (1999). Dietary factors and survival of women with breast cancer. *Cancer* **86**, 826–35.
- Jamrozik K (2005). Estimate of deaths attributable to passive smoking among UK adults: database analysis. *BMJ* **330**, 812–15.
- Kauff ND, Domchek SM, Friebel TM, et al. (2008). Risk reducing salpingo-oophorectomy for the prevention of BRCA1- and BRCA2-associated breast and gynecologic cancer: a multicenter, prospective study. *J Clin Oncol* **26**, 1331–7.
- Kloos RT, Eng C, Evans DB, et al. (2009). Medullary thyroid cancer: management guidelines of the American Thyroid Association. *Thyroid* **19**, 565–612.
- Lostumbo L, Carbine NE, Wallace J (2010). Prophylactic mastectomy for the prevention of breast cancer. *Cochrane Database Syst Rev* **10**, CD002748.
- Lynch HT, Kaurah P, Wirtzfeld D, et al. (2008). Hereditary diffuse gastric cancer: diagnosis, genetic counseling, and prophylactic total gastrectomy. *Cancer* **112**, 2655–63.
- Marrett LD, De P, Airia P, Dryer D (2008). Cancer in Canada in 2008. *Can Med Assoc J* **179**, 1163–70.
- McTiernan A (2003). Behavioural risk factors in breast cancer—can risk be modified? *Oncologist* **8**, 326–34.
- Mowat C, Cole A, Windsor A, et al. (2011). Guidelines for the management of inflammatory bowel disease in adults. *Gut* **60**, 571–607.
- Norat T, Lukanova A, Ferrari P, Riboli E (2002). Meat consumption and colorectal cancer risk—dose response meta-analysis of epidemiological studies. *Int J Cancer* **98**, 241–56.
- Osborne M, Boyle P, Lipkin M (1997). Cancer prevention. *Lancet* **349**(Suppl 2), S1127–30.
- Patel SG, Ahnen DJ (2012). Familial colon cancer syndromes: an update of a rapidly evolving field. *Curr Gastroenterol Rep* **14**, 428–38.
- Potter JD (1999). Fiber and colorectal cancer—where to now? *N Engl J Med* **340**, 223–4.
- Slatore CG, Littman AJ, Au DH, Satia JA, White E (2007). Long-term use of supplemental multivitamins, vitamin C, vitamin E, and folate does not reduce the risk of lung cancer. *Am J Respir Care Med* **177**, 524–30.
- Turner N, Jones AL (2008). Management of breast cancer—part I. *BMJ* **337**, a421.
- Wands JR (2004). Prevention of hepatocellular carcinoma. *N Engl J Med* **351**, 1567–70.
- Willett WC, Stampfer MJ, Colditz GA, Rosner BA, Speizer FE (1990). Relationship of meat, fat and fiber intake to the risk of colon cancer in a prospective study among women. *N Engl J Med* **323**, 1664–72.

# Population screening for cancer

Screening for cancer 218

Further reading 222

## Screening for cancer

### Principles

Screening is the process whereby asymptomatic individuals are tested in order to detect a disease that has yet to be symptomatic. For this to be effective in a population, there are certain criteria that must be met by the disease in question, the screening test, and the screening programme.

#### *The disease*

- Its natural history is well understood.
- It has a recognizable 'early' stage.
- Treatment at an early stage is more successful than at a later stage.
- It is sufficiently common in the target population to warrant screening.

#### *The test*

- Sensitive and specific.
- Acceptable.
- Safe.
- Inexpensive.

#### *The programme*

- Adequate facilities for diagnosis in those with a positive test.
- High quality of treatment for screen-detected disease.
- Screening repeated at intervals if the disease is of insidious onset.
- Benefit must outweigh physical and psychological harm.
- Benefit must justify the financial cost.

It is crucial that treating the disease to be screened at an early stage is more effective than treating at a later stage. To justify a screening programme, one cannot compare the outcome of screen-detected disease with that of symptomatic disease, because three biases operate in favour of screen-detected disease.

- Lead time bias arises from the fact that, if early diagnosis advances the time of diagnosis of a disease, then the period from diagnosis to death will lengthen, irrespective of whether or not treatment has altered the natural history of the disease. If patients die of their cancer at the same age at which this event would have occurred without screening, no benefit has been afforded by screening. Screening will only be of value if it improves the survival curve of a screened population, compared with unscreened.
- Length bias operates, as slow-growing tumours are more likely to be detected by screening tests, when compared to fast-growing tumours, which are more likely to present with symptoms before a screening test can be applied or between tests. Thus, screen-detected tumours will tend to be less aggressive and associated with a relatively good prognosis.
- Selection bias results from the characteristics of individuals who accept an invitation to be screened. Such a person is more likely to be health-conscious than one who refuses or ignores screening and may therefore be more likely to survive longer, irrespective of the disease process.

## Screening

In screening, it is also important to have a target population to avoid large numbers of fruitless tests in individuals at low risk of cancer. In screening for the common cancers, where the incidence is highly age-dependent, the age range should be that in which the disease is relatively common and in which the patients are likely to be fit, enough for curative treatment.

There are other predictors of risk, and family history is becoming important in this respect, particularly as it is now possible to detect specific genetic mutations from blood samples and to use these to screen close relatives. Examples of this are mutations in the *APC* gene in FAP, in the DNA mismatch repair genes in HNPCC, and in the *BRCA1* and *2* genes in familial breast and ovarian cancers.

A screening test must be acceptable and safe, so that it will be adopted by the target population. It must also be sensitive and specific. Sensitivity is the proportion of individuals with the disease who have a positive test, and specificity is the proportion of individuals without the disease who have a negative test.

## Screening programmes

When a screening programme is established, it is important that the diagnostic facilities are adequate. Similarly, treatment of early disease must be associated with minimal morbidity and mortality.

It must also be remembered that screening may cause psychological harm, and, along with any physical morbidity caused by investigation and treatment, this represents part of the cost of screening. The benefits gained through cancer screening must outweigh such morbidity, and society must make a decision whether or not the health gain justifies these and the financial costs.

### *Breast cancer screening*

The breast cancer screening programme, first introduced in the UK in 1986, currently consists of 3-yearly mammography of women between 50 and 70 years of age. Women over 70 are entitled to screening, with appointments arranged via their general practitioner (GP) or local screening unit.

It is now accepted that mammographic screening reduces mortality, with breast cancer mortality falling steeply since the 1980s in the UK, indeed as a result of the screening programme, more so than in any major European country. The statistics, according to a Cochrane review, suggest that 2000 women need to be screened for 10 years to prevent one death from breast cancer.

A further concern was the overdiagnosis of small cancers—cancers that would not likely have been diagnosed and treated in a woman's lifetime. In an analysis of Swedish RCT and NHS screening data, it was shown that 2–2.5 lives are saved for every overdiagnosed case.

There is current debate about the cost effectiveness of beginning breast cancer screening under the age of 50 years. This is discussed in detail in ➔ Breast cancer screening, pp. 274–6.

*Cervical cancer screening*

Cervical cancer screening is performed in the UK by GPs. The programme invites women aged 25–50 every 3 years, and those aged 50–64 every 5 years, for a cervical smear. Liquid-based cytology is used to detect evidence of dyskaryosis. For mild dyskaryosis, a repeat smear or colposcopy is recommended, and, for those with moderate or severe dyskaryosis, a colposcopy is arranged. The colposcopy allows improved visualization and biopsy, and so a more accurate assessment of cervical intraepithelial neoplasia (CIN).

Whilst screening was introduced in a non-controlled fashion, in the absence of clinical trials, it is thought that the decrease in mortality from cervical cancer is largely due to screening.

The US Preventative Service Task Force (USPSTF) has released new guidelines in 2013, recommending screening women aged 21–65 years with cytology every 3 years, and for women aged 30–65 years who want to lengthen the screening interval, screening with a combination of cytology and HPV testing every 5 years.

*Colorectal cancer screening*

The NHS bowel cancer screening programme commenced in England in 2006, inviting men and women aged 60–69 years, and has since been extended up to the age of 75 years. There are slight variations in protocol across England, Northern Ireland, Scotland, and Wales (<http://www.screening.nhs.uk/bowelcancer-compare>). Screening is by means of a home faecal occult blood (FOB) test. Patients with no blood are reassured and offered a further test in 2 years. If traces of blood are identified, individuals are requested to retest on up to two further occasions. Individuals with definite positive results are called for a nurse review and offered colonoscopy. The data show that the cost of this programme is ~£20 000 per year of life saved. It has been estimated that 2500 lives will be saved each year in the UK by 2025 by bowel cancer screening.

In 2016, an additional screening option will consist of a one-off flexible sigmoidoscopy at age 55.

In the US, screening begins at age 50 until 75. The USPTSF recommends different schedules, depending on the screening procedure used. For programmes using FOB testing, annual high-sensitivity FOBs are recommended, and for clinicians using flexible sigmoidoscopy as procedure every 5 years and for colonoscopy, an examination every 10 years.

Those at high risk of colorectal cancer should have screening earlier and more frequently.

*Lung and prostate cancer*

There are currently no national screening programmes for lung or prostate cancer in the UK.

The potential for lung cancer screening is currently being assessed by the United Kingdom Lung Cancer Screening (UKLS) trial, sponsored by the Department of Health, which has recently closed after randomizing a study group of 4000 individuals into screening with low-dose CT or observation. Results are expected in 2016. The National Lung Cancer Screening Trial in the US studied 50 000 individuals and showed a 20% decrease in lung cancer



deaths. The American Cancer Society does not currently recommend general population screening but does so for smokers aged 50–74 who are generally fit, have a 30-year pack history, and who are current smokers or have ceased in the past 15 years.

There is currently no national screening programme for prostate cancer in the UK, but Public Health England are currently reviewing the need for such a programme, with guidelines expected to be published soon. The American Cancer Society guidelines advocate patient choice after discussion with their doctor, as there is currently no evidence for a benefit of screening.

## Further reading

- Agrawal J, Syngal S (2005). Colon cancer screening strategies. *Curr Opin Gastroenterol* **21**, 59–63.
- Beral V, Peto R (2010). UK cancer survival statistics. *BMJ* **341**, c4112.
- Berry DA (1998). Benefits and risks of screening mammography for women in their forties—a statistical appraisal. *J Natl Cancer Inst* **90**, 1431–9.
- Duffy SW, Tabar L, Olsen AH, et al. (2010). Absolute numbers of lives saved and overdiagnosis in breast cancer screening, from a randomized trial and from the Breast Cancer Screening Programme in England. *J Med Screen* **17**, 25–30.
- Elmore JG, Barton MB, Mocerri VM, Polk S, Arena PJ, Fletcher SW (1998). Ten-year risk of false positive screening mammograms and clinical breast examinations. *N Engl J Med* **338**, 1089–96.
- Goodman GE (1992). The clinical evaluation of cancer chemoprevention agents: defining and contrasting phase I, II and III objectives. *Cancer Res (Suppl)* **52**, 2752–7.
- Harris R, Lohr KN (2002). Screening for prostate cancer—an update of the evidence for the US Preventative Services Task Force. *Ann Intern Med* **137**, 917–29.
- Kmietowicz Z (2009). Screening for bowel cancer is set to save 2500 lives a year in UK. *BMJ* **337**, a3125.
- Mayor S (2004). England to start national bowel cancer screening programme. *BMJ* **329**, 1061.
- Meyskens FL Jr (1992). Biomarker intermediate endpoints and cancer prevention. *J Natl Cancer Inst Monogr* **13**, 177–81.
- Peto J, Gilham C, Fletcher O, Matthews FE (2004). The cervical cancer epidemic that screening has prevented in the UK. *Lancet* **364**, 249–56.
- Shaheen NJ, Indomi JM, Overholt BF, Sharma P (2004). What is the best management strategy for high grade dysplasia in Barrett's oesophagus? A cost effectiveness analysis. *Gut* **53**, 1736–44.
- Sporn MB (1993). Chemoprevention of cancer. *Lancet* **342**, 1211–12.
- Turner NS, Jones AL (2008). Management of breast cancer—part I. *BMJ* **337**, a421.
- Van Schoor G, Broeders MJM, Paap E, Otten JD, den Heeten GJ, Verbeek AL (2008). A rationale for starting breast cancer screening under age 50. *Ann Oncol* **19**, 1208–9.
- Wilson DD, Weissfeld JL, Fuhrman CR, et al. (2008). The Pittsburgh Lung Screening study (PLuSS): outcomes within 3 years of a first computed tomography scan. *Am J Respir Crit Care Med* **178**, 956–61.
- Winawer S, Fletcher R, Rex D, et al. (2003). Colorectal cancer screening and surveillance: clinical guidelines and rationale—Update based on new evidence. *Gastroenterology* **124**, 544–60.

## Part 4

# Specific types of cancer

13	Thoracic malignancies	225
14	Breast cancer	261
15	Colorectal cancer	299
16	Anal cancer	311
17	Upper gastrointestinal cancer	317
18	Endocrine cancers	381
19	Genitourinary cancers	403
20	Gynaecological cancers	445
21	Head and neck cancers	467
22	Tumours of the central nervous system	495
23	Skin cancers	523
24	Haematological malignancies	549
25	Bone and soft tissue malignancies	603
26	Malignancy of unknown primary	629
27	Paraneoplastic syndromes	645
28	AIDS-related malignancies	655
29	Childhood cancers presenting in adults	671



# Thoracic malignancies

- Lung cancer 226
- Non-small-cell lung cancer 232
- Surgery for non-small-cell lung cancer 234
- Chemotherapy for non-small-cell lung cancer 238
- Radiotherapy for non-small-cell lung cancer 242
- Small-cell lung cancer 245
- Chemotherapy for small-cell lung cancer 246
- Radiotherapy for small-cell lung cancer 248
- Surgery for small-cell lung cancer 250
- Mesothelioma 252
- Thymic tumours 256
- Surgery for pulmonary metastatic disease (metastasectomy) 259

## Lung cancer

### Epidemiology

The statistics are a stark reminder of the cost of this largely preventable disease.

- The second commonest cancer in the UK (breast cancer commoner), 13% of all cancers.
- In 2009, there were 42 026 new lung cancers in the UK, affecting 23 175 men and 18 851 women.
- Lung cancer is the most frequent cause of cancer deaths in both men and women in the UK and US.
- In 2010, there were 34 859 deaths from lung cancer in the UK, 160 000 deaths in the US.
- The incidence and mortality rate are falling in men in these countries, but rising in women in the UK (see Table 13.1).
- Worldwide, the incidence is continuing to rise, particularly in developing countries, as cigarette smoking becomes more prevalent.
- Survival rates remain dismal, with 5y survival of <9% in the UK, <15% in the US.

### Aetiology

- 80–90% of lung cancers are due to smoking.
- The risk of lung cancer relates to the number of cigarettes smoked, the number of years of smoking, early age starting to smoke, and the type of cigarette (greater risk with unfiltered and high nicotine).
- <10% of lung cancers occur in never-smokers, usually women.
- Passive smoking.
- Asbestos.
- Previous radiotherapy to the chest.
- Rarely, inhalation of radon gas, polycyclic aromatic hydrocarbons, nickel, chromate, or inorganic arsenicals.

### Screening and prevention

- Lung cancer is a preventable disease.
- Currently, 30% of the adult population of the UK smokes.
- Health education has had some success in reducing tobacco consumption in men.
- However, smoking in women and adolescents is increasing in the UK.
- Stopping smoking reduces the risk of developing lung cancer.
- Nicotine replacement therapy can improve smoking cessation rates.
- Screening with chest X-ray (CXR) and sputum cytology does not reduce mortality from lung cancer.
- Clinical trials are currently testing whether regular spiral CT scans of the chest might be a useful screening tool for lung cancer, e.g. in smokers.
- The UK ban on smoking in public and workplaces from 2007 may, in the longer term, decrease lung cancer rates with less passive smoking.

**Table 13.1** Lung cancer incidence figures

Sex	UK incidence by year (age-adjusted, per 100 000 population)	
	1980	2009
♂	113	59
♀	28	39

## Pathology

There is evidence that lung cancers may arise in pluripotent stem cells in the bronchial epithelium, and this would certainly offer an explanation for the mixed histology that is fairly commonly seen. The 2004 WHO pathological classification is as follows:

1. SCC (30%)
2. small-cell carcinoma (SCLC, 15–20%)
3. adenocarcinoma (40%):
  - a. minimally invasive
  - b. invasive
  - c. variants, e.g. mucinous adenocarcinoma
4. large-cell carcinoma
5. adenosquamous carcinoma
6. sarcomatoid carcinoma
7. carcinoid tumour
8. carcinomas of salivary gland type:
  - a. mucoepidermoid carcinoma
  - b. adenoid cystic carcinoma
9. unclassified carcinomas.

For the purposes of management, lung cancers are grouped as NSCLC or SCLC, but, within the former, certain patterns of disease do relate to the histological subtype. For example, squamous cancers typically arise in proximal segmental bronchi and grow slowly, disseminating relatively late in their course. Adenocarcinomas are often peripheral in origin, and even small resectable lesions carry a risk of occult metastases. Common sites of metastatic spread include the regional lymph nodes, bone, liver, adrenal, lung, CNS, and skin.

However, the risk of dissemination is greatest in SCLC where it is estimated that >90% of patients have either overt or occult metastases at presentation. These aggressive tumours, derived from neuroendocrine cells, most frequently arise in large airways but can rarely present as a small peripheral nodule. The latter presentation may be indicative of a different pathology with an inherently better prognosis.

Recent progress in the molecular subclassification of NSCLC has resulted from the identification of driver mutations, particularly in adenocarcinomas, which can provide targets for systemic therapy. Mutations of the EGFR TK domain, which may result in sensitivity to EGFR TKIs, occur mainly in ♀ non-smoking patients, in particular those of Asian origin. Chromosomal rearrangement leads to the activation of the anaplastic lymphoma kinase (ALK) gene in 3–6% of NSCLC and similarly predicts the sensitivity to treatment with the ALK inhibitor crizotinib.

### Genetics

The majority of clinically apparent lung cancers have >20 genetic alterations acquired in a stepwise fashion. These may disrupt cell cycle regulation and cause genomic instability, but they also result in failure to undergo apoptosis, the invasion of normal tissues, and dissemination to other tissues. Examples of the relevant genes include:

- oncogene activation:
  - EGFR overexpression, leading to the stimulation of this proliferative pathway (70% of SCLCs, 40% of adenocarcinomas)
  - point mutation of *RAS* or *MYC*, activating signal transduction pathways
- tumour suppressor gene inactivation:
  - *p53* alteration is frequent (>80% of SCLC, 50% of NSCLC)
  - high *BCL2* expression in SCLC protects against apoptosis
- angiogenesis—tumour progression and metastasis:
  - VEGF receptor—high levels of VEGF expression are detected in 50% of all lung cancers
- telomerase activation occurs in 100% of SCLC and 80% of NSCLC
- specific genetic alterations in NSCLC, such as the driver EGFR TK mutation, should be specifically sought in adenocarcinomas.

#### *Genetic predisposition to development of lung cancer*

- Family history of lung cancer increases the risk by  $\times 2.5$ , even when smoking is taken into account.
- Likely mechanisms include genetic variation in the enzymes responsible for carcinogen metabolism and detoxification, and DNA damage repair.
- Rarely, germline mutation of *Rb* or *p53*.

### Presenting symptoms and signs

Typically, presentation is late, symptoms such as persistent cough and dyspnoea being attributed to smoking. Small adenocarcinomas in the periphery of the lung may be asymptomatic, picked up on CXR or CT scan done for coincidental indication.

- Persistent cough, haemoptysis, dyspnoea.
- Recurrent chest infections.
- Pleural effusion.
- Chest pain (constant, progressive).
- Hoarse voice (vocal cord palsy).
- Wheeze, stridor.
- SVC obstruction (SVCO).
- Horner's syndrome, arm or hand pain, and neurological deficit (apical cancer).
- Fatigue.
- Anorexia, weight loss.
- Paraneoplastic syndromes (see Chapter 27).
- Symptoms from metastatic disease.



## Investigations

(See Fig. 13.1 and *NICE Guideline 121*, 2011.)

After physical examination and CXR, patients with suspected lung cancer require further imaging with CT scan (chest and abdomen, including the liver and adrenals) and a tissue diagnosis, obtained by the least invasive route. Increasingly, core biopsy is preferred over FNA cytology, in order to provide a more accurate molecular subclassification of lung cancer:

- sputum cytology (rarely used now)
- core biopsy or FNA cytology from palpable disease, most commonly supraclavicular fossa (SCF) nodes
- bronchoscopy with direct biopsy, brushings/washings for cytology, or transbronchial biopsy of the lung or lymph node (e.g. under EUS control)
- pleural aspirate cytology or pleural biopsy
- FNA or core biopsy of peripheral lung lesion
- FNA or core biopsy in metastatic disease, e.g. liver
- mediastinoscopy and lymph node biopsy
- video-assisted thoracoscopic surgery (VATS) and biopsy
- rarely, open lung biopsy.

Other important assessments include performance status (see Table 13.2), pulmonary function tests, full blood count (FBC), and biochemical profile. Patients with symptoms suggestive of metastatic disease may require isotope bone scan or CT brain.

**Table 13.2** Performance status scales, NICE guidelines

WHO (Zubrod) scale	Karnofsky scale
0, asymptomatic	100, asymptomatic
1, symptomatic but ambulatory (able to carry out light work)	90, normal activity, minor symptoms
	80, normal activity, some symptoms
2, in bed <50% of day (unable to work but able to live at home with some assistance)	70, unable to work, cares for self
	60, occasional assistance with needs
3, in bed >50% of day (unable to care for self)	50, considerable assistance
	40, disabled, full assistance needed
4, bedridden	30, needs some active supportive care
	20, very sick, hospitalization needed
	10, moribund
	0, dead

Reproduced from Detterbeck FC, et al. (2001). *Diagnosis and treatment of lung cancer: an evidence-based guide for the practising clinician*. Philadelphia: WB Saunders, p. 40, with permission from Elsevier.

All patients undergoing investigations for suspected lung cancer should be seen by a lung cancer clinical nurse specialist to help guide and inform them through this process and facilitate communication between the MDT, GP, and patient.

The importance of smoking cessation should be emphasized, even before the diagnosis is confirmed.

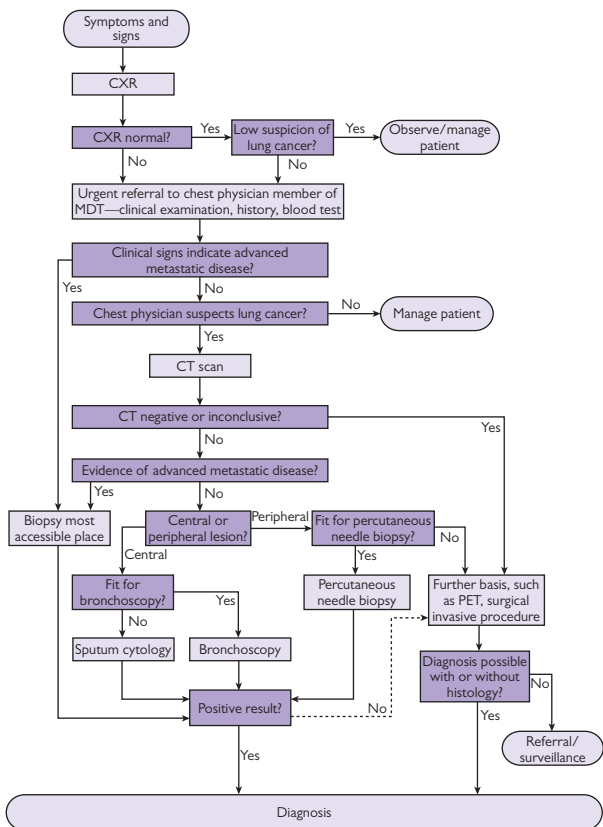



Fig. 13.1 Diagnosis of lung cancer.

MDT, multidisciplinary team; PET, positron emission tomography. Reproduced with permission from the National Clinical Guidelines Centre – Acute and Chronic Conditions (2005).



## Non-small-cell lung cancer

### Staging

(See  <https://cancerstaging.org> to download the TNM staging; also see Fig. 13.2 and NICE Guideline 121, 2011.)

The following assessments are required:

- clinical examination (particular attention to cervical, SCF, and axillary lymphadenopathy, and soft tissue masses, e.g. chest wall)
- CT of the chest and abdomen:
  - size and site of the 1° tumour
  - relationship to the lung fissures, mediastinum, chest wall
  - mediastinal or other lymphadenopathy (may also require ultrasound examination of neck nodes)
  - metastatic disease, in particular, the lung, pleura, liver, adrenal, bone
  - CT brain and isotope bone scan performed if clinical suspicion of metastatic disease
- bronchoscopy (performed after CT):
  - movement of vocal cords
  - site of the endobronchial tumour in relation to the carina and major bronchial divisions
  - extrinsic compression of the bronchi
  - may be combined with transbronchial needle aspiration (TBNA), assisted by endobronchial ultrasound (EBUS), if lymphadenopathy (>10mm) apparent on CT.

### Positron emission tomography scanning

Fluorodeoxyglucose PET (FDG-PET) scanning has greater sensitivity and specificity than CT scan for staging NSCLC and is recommended for preoperative assessment. It is also recommended to exclude metastatic disease in patients being considered for radical non-surgical treatment.

### Mediastinal node biopsy

Lymph node biopsy is required when PET-CT scan suggests localized lymph node spread, either by TBNA, assisted by EBUS and/or EUS, or by mediastinoscopy.

### Other investigations

Solitary metastatic disease in an otherwise potentially curable case requires biopsy to confirm. Increasingly, CT or MRI of the brain is used to exclude CNS metastasis in patients being considered for radical therapy for stage III disease.

### Multidisciplinary team meetings

Key to the optimal management of lung cancers is the multidisciplinary discussion of each case, with input from radiologists and pathologists, as well as chest physicians, thoracic surgeons, clinical and medical oncologists, and lung cancer nurse specialists. The team should consider the sequence of investigations, in order to maximize the derived information concerning the diagnosis and staging of the disease, with minimum risk to the patient.

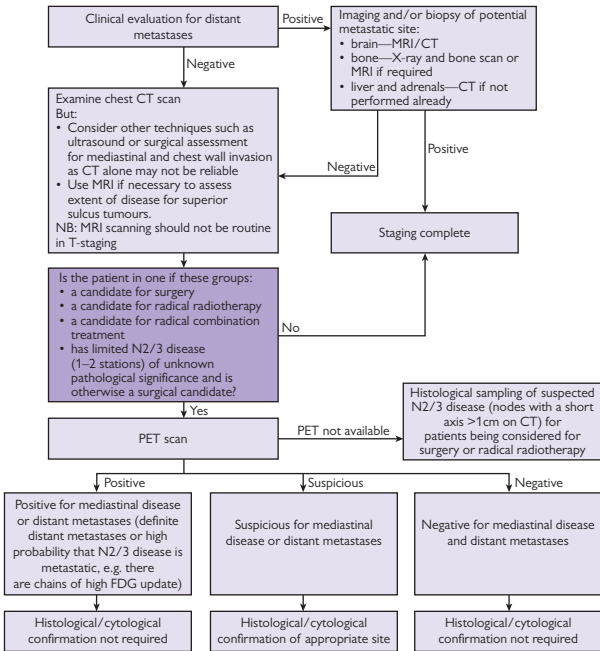

**Fig. 13.2** Histological sampling of suspected N2/3 disease (nodes with a short axis of >1cm on CT) for patients being considered for surgery or radical radiotherapy. Reproduced with permission from the National Clinical Guidelines Centre – Acute and Chronic Conditions (2005).

## Surgery for non-small-cell lung cancer

### Introduction

- Surgical resection with curative intent is regarded as the treatment of first choice for patients with NSCLC.
- The principle of surgical resection is to achieve clear margins, and every patient with non-metastatic NSCLC should be considered for surgical treatment.
- The Society of Cardiothoracic Surgery has indicated that, in the UK, the number of patients undergoing surgery has increased by 60% in recent years, and the perioperative mortality has halved.

### Principle of surgery

#### Preoperative assessment

Before embarking on surgery, all cases should be discussed in an MDT setting, and the following elements confirmed:

- histological/cytological confirmation of the diagnosis
- operable stage of the disease:
  - no evidence of metastasis on PET scan
  - mediastinoscopy and lymph node biopsy may be required if endobronchial and endoscopic biopsies are inconclusive—lymph nodes that appear of normal size on CT (<1cm in diameter) may contain cancer (~15%), whilst enlarged lymph nodes are commonly reactive (45%)
  - in the presence of a pleural effusion, aspirated fluid cytology and pleural biopsy should be negative for cancer cells before proceeding with an operation
- fitness for surgery.

A detailed protocol for the preoperative work-up is included in the British Thoracic Society (BTS) guidelines.

- Age is not an absolute contraindication.
- Need to take into account the performance status, weight loss, and co-morbidities that may exclude surgery as a feasible option.
- Pulmonary function tests, spirometry, and gas transfer, taking account of predicted values and the extent of surgery planned.
- Cardiac assessment—may require exercise testing and at least an echocardiography.
- Avoid lung resection within 30 days of myocardial infarction (MI), and commence/continue anti-ischaemic treatments pre- and post-operatively.

Thoracotomy and major lung resection carry significant risks of morbidity and mortality. Surgery for lung cancer should be carried out promptly in a unit with the appropriate level of experience and expertise. In the majority of patients, general anaesthesia, with the use of a double-lumen endotracheal tube, is desirable to allow one-lung ventilation during thoracotomy. With specialization, increasingly resections are being done using a VATS approach, as this is associated with similar oncological outcomes, but with less post-operative morbidity.

### *Surgical techniques*

The extent of surgery will depend on the anatomical location, size, and stage of the tumour.

- The standard approach is a lobectomy, using either an open or thoracoscopic approach.
- More extensive surgery (bronchoangioplastic, bilobectomy, pneumonectomy) is justified, in order to obtain negative margins in selected patients.
- For patients with smaller tumours (T1a–b, N0, M0) and those of borderline fitness, segmental or wedge resection may be considered, as long as complete resection can be achieved.
- Patients with T3 disease, with involvement of the chest wall, pericardium, or diaphragm, can be considered candidates for resection if an en bloc dissection can be performed with negative margins.
- All operations should include hilar and mediastinal lymph node sampling.

### *Post-operative management*

Patients should be nursed in an intensive care or high dependency unit, with adequate monitoring of the:

- electrocardiogram (ECG)
- BP
- central venous pressure (CVP)
- respiratory rate
- O<sub>2</sub> saturation.

Adequate pain control is essential, following a thoracotomy, and can be provided by:

- thoracic epidural anaesthesia (now routine)
- IV opiates administered by patient-controlled analgesia (PCA)
- intercostal nerve block prior to wound closure.

Routine post-operative ventilation is no longer needed.

O<sub>2</sub> therapy is required in the early post-operative stage, preferably through a nebulizer, and, in patients with significant airways obstruction, a bronchodilator should be added. Regular chest physiotherapy is essential, together with incentive spirometry.

### *Post-operative complications*

#### *Early (within days)*

- Haemorrhage (e.g. after dissection of pleural adhesions) may result in a haemothorax.
- Respiratory failure:
  - opiate-induced respiratory depression
  - pneumothorax with, or without, surgical emphysema
  - atelectasis due to retained bronchial secretions.
- Prolonged air leak following a lobectomy.
- Cardiac arrhythmias, particularly atrial fibrillation (AF).
- Sepsis:
  - chest infection
  - wound infection
  - empyema.
- Broncho-pleural fistula (particularly on the right, following a pneumonectomy).

*Late (within weeks to months)*

- Post-thoracotomy pain.
- Late broncho-pleural fistula with empyema.

#### **Results of lung resection**

The post-operative mortality rate should be <3% following a lobectomy, and <5% following a pneumonectomy. The 5y survival is influenced by a number of factors, the most important of which is the pathological staging (see Table 13.3). Overall, the 5y survival for patients undergoing resection may be as high as 40%, approaching 70% in cases without nodal involvement (N0). However, when mediastinal nodes are involved (N2), only 15% of patients will survive 5y.

#### **Adjuvant chemotherapy**

- Offer cisplatin-based combination adjuvant chemotherapy to patients with a good performance status (WHO 0 or 1) and T1–3, N1–2, M0 NSCLC.
- Consider the same regimen with T2–3, N0, M0 tumours of >4cm in size.

**Table 13.3** 5y survival after surgery for NSCLC

Stage	5y survival (%)
IA	58–73
IB	43–58
IIA	36–46
IIB	25–36
IIIA	19–24
IIIB	7–9
IV	2–13





## Chemotherapy for non-small-cell lung cancer

Older studies with alkylating agents in advanced NSCLC showed decreased survival with chemotherapy, and, until the 1980s, no systemic treatments were available with objective response rates in excess of 20%. Over the last 20y, there has been significant progress in this area and an increasing use of chemotherapy in most stages of the disease.

### Metastatic disease

#### *Tumour response and survival*

Cisplatin-based chemotherapy with 1980s regimens, such as MVP (mitomycin, vinblastine, cisplatin) and MIC (mitomycin, ifosfamide, cisplatin), produced significant benefits in stage IV disease.

- Symptom relief and improved quality of life in >50%.
- Objective response rate of 20–30%:
  - little benefit and increased toxicity in patients with performance status (PS) 2 or worse.
- Modest impact on survival:
  - median survival increased by 2mo, compared with no chemotherapy
  - 1y survival of 25% (without chemotherapy 15%).
- Toxicities of treatment include nausea, vomiting, lethargy, myelosuppression, sepsis, thromboembolism, and neuropathy.

During the 1990s, several new drugs demonstrated anti-tumour activity in NSCLC as single agents and in combination with carboplatin or cisplatin (see Table 13.4 and Table 13.5).

- These drugs included docetaxel, gemcitabine, paclitaxel, and vinorelbine.
- Doublet regimens (one new drug plus a platinum complex) proved superior to MVP/MIC, in terms of response rate and survival.
- None of the new chemotherapy regimens appeared superior to the others.
- Doublet therapy with the combination of either cisplatin or carboplatin and one of gemcitabine/vinorelbine/paclitaxel/docetaxel was accepted as standard therapy for advanced NSCLC (approved by NICE in June 2001).
- Little evidence to justify >4 cycles of chemotherapy.
- Single-agent chemotherapy with agents, such as gemcitabine or vinorelbine, can be of modest benefit in patients with advanced disease and PS 2.

#### *Recent advances in chemotherapy for non-small-cell lung cancer*

Since 2000, significant progress has been made in the systemic treatment of advanced NSCLC:

- first-line therapy can be tailored to the molecular subtype of NSCLC
- pemetrexed and cisplatin or carboplatin preferred for adenocarcinoma or large-cell carcinoma (median survival 12.6 and 10.4mo, respectively)
- EGFR TKIs (erlotinib or gefitinib) for adenocarcinoma with sensitive EGFR TK mutation (PFS >9mo, OS 19mo)
- Crizotinib for adenocarcinoma with chromosomal rearrangement leading to activation of ALK (PFS >9mo, OS not yet known)

- second-line treatment of advanced disease is feasible and of modest benefit in patients with a good performance status, usually with single-agent chemotherapy which the patient has not previously received—docetaxel, or pemetrexed, or erlotinib.

### Quality of life

Although cytotoxic regimens produce objective tumour response rates of the order of 20–50% in advanced NSCLC, symptom improvement can be achieved in a greater proportion of patients.

- Cough, haemoptysis, and pain are relieved in 70%.
- Anorexia in 40%.
- Dyspnoea in 30%.

**Table 13.4** Single agents for NSCLC—results in stages IIIB–IV

Drug	Number of patients	1y survival (%)	Median survival (wk)	Response rate (%)
Vinorelbine	621	20	32.5	24
Gemcitabine	572	21	40.6	39
Paclitaxel	317	26	37.3	41
Docetaxel	300	26	41	52
Topotecan	119	13	38	35

Data from Bunn PA Jr, Kelly K (1998). New chemotherapeutic agents prolong survival and improve quality of life in non-small cell lung cancer: a review of the literature and future directions. *Clin Cancer Res* 4, 1087–100.

**Table 13.5** Platinum-based combination therapies for NSCLC

Drug combination	Number of patients	Response rate (%)	Median survival (wk)	1y survival (%)
Paclitaxel + C	333	46	38	40
Vinorelbine + P	328	41	38	35–40
Paclitaxel + P	286	42	42	36
Docetaxel + P	255	35	35	58
Gemcitabine + P	245	47	57	61
Topotecan + P	22	22	32	26

P, cisplatin; C, carboplatin.

Data from Bunn PA Jr, Kelly K (1998). New chemotherapeutic agents prolong survival and improve quality of life in non-small cell lung cancer: a review of the literature and future directions. *Clin Cancer Res* 5, 1087–100.

**Stage III disease**

About 30% of NSCLC patients present with locally advanced disease, but with no evidence of metastases. This is a heterogeneous group, with an overall poor prognosis, but includes some patients who may have durable responses to appropriate radical therapy. In general, responses to chemotherapy are more frequent in localized, compared with metastatic, disease, but the benefits of chemotherapy are again limited to patients with a good performance status.

The same cisplatin or carboplatin chemotherapy doublets are used, with the following principles:

- response to chemotherapy should improve symptoms, reduce loco-regional disease prior to local therapy, and reduce microscopic metastatic disease
- platinum-based combination chemotherapy, followed by radiotherapy, gives better survival rates than radiotherapy alone (3y survival of 13–23% versus 6%)
- a commonly used regimen for patients with PS 0–1 is four cycles of a platinum-based doublet, followed by radiotherapy, to residual chest disease
- patients with progressive disease or serious toxicity on chemotherapy require prompt treatment with radiotherapy
- patients with a poor performance status may be treated with palliative radiotherapy only
- selection and coordination of appropriate therapy require close cooperation of medical and radiation oncologists within the MDT.

**Chemo-radiotherapy**

Cisplatin and vinorelbine are potent radiosensitizers, and there is increasing evidence that concomitant delivery of chemotherapy and radiotherapy is more effective than sequential delivery, but toxicity (in particular, oesophagitis and pneumonitis) remains a problem, and an optimum chemotherapy regimen and fractionation schedule for radiotherapy are yet to be determined.

**Surgery for locally advanced disease**

Where stage III disease appears resectable by pneumonectomy (e.g. stage IIIA disease where only the ipsilateral mediastinal nodes are involved), surgery cures <10% of patients because of a combination of unresected loco-regional disease and occult systemic disease. Chemotherapy improves survival over surgery alone by around 5% at 5y. Several small studies have suggested a survival advantage for preoperative chemotherapy (with or without radiotherapy) in stage III disease. Five-year survival rates of up to 40% have been reported, but this has been achieved in small, selected groups of patients. Two recent randomized studies have shown significantly improved relapse-free and overall survival for patients given cisplatin-based treatment before and after surgery.

Overall, the data are not dissimilar from those seen with chemotherapy followed by radiotherapy in unresectable disease, and it is not clear if surgery has a role in this situation. On the other hand, only 5–15% of patients undergoing neoadjuvant therapy have a pathological complete response at surgery, demonstrating the importance of further local treatment if cure is the aim. Large phase III trials of chemo-radiotherapy pre-surgery, and of chemotherapy followed by radiotherapy or surgery, are in progress to help clarify this issue.

### Adjuvant chemotherapy

Thirty to 40% of patients with stage II NSCLC relapse after surgery only, with systemic metastatic disease. A meta-analysis of adjuvant chemotherapy trials in NSCLC showed a 5% improvement in 5-year survival for patients treated with a cisplatin-based regimen after surgical resection. This benefit held for patients across stages IB–IIIA. Recent results with platinum-based doublet chemotherapy (e.g. cisplatin vinorelbine or carboplatin paclitaxel) suggest particular benefit as adjuvant therapy after surgery for stages II–IIIA disease.

Whilst neoadjuvant strategies offer potential downstaging of the disease, increasing the likelihood of a complete resection and theoretical reduction in the risk of tumour dissemination at surgery, no studies have yet shown preoperative chemotherapy to be superior to post-operative adjuvant therapy.

### Conclusion

Chemotherapy for inoperable NSCLC now offers benefits similar to those obtained with chemotherapy in SCLC, in terms of survival. Results of adjuvant treatment also suggest that a survival benefit, comparable to that observed in breast and colorectal cancers, can be achieved. Grounds for the previous nihilistic view of NSCLC chemotherapy are diminishing, but patients still need to be entered into clinical trials, wherever possible, in order to build on this progress.

## Radiotherapy for non-small-cell lung cancer

EBRT is used as the local treatment for thoracic disease in the majority of unresectable NSCLC patients, and local tumour control rates and the duration correlate with the dose of radiotherapy given.

### Radical radiotherapy

- Radical radiotherapy is indicated for:
  - patients with stages I–II NSCLC who are unfit for surgery
  - stages IIIA and IIIB disease that can be encompassed in a feasible volume (determined by both the tumour volume and pulmonary function of the patient) in patients with a good performance status.
- Patients with inoperable NSCLC have a 20–30% chance of surviving 2 years after radical radiotherapy.
- The cost of radical treatment includes:
  - frequent hospital attendances
  - acute toxicities, e.g. lethargy, oesophagitis
  - late toxicities, e.g. lung fibrosis.
- Patient selection is crucial to minimize the risk of prolonged side effects in patients destined to die of systemic disease within 12mo of diagnosis.

### Dose and fractionation

- The standard international dose is 60–66Gy in 30–33 fractions over 6wk.
- Attempts to increase the tumour dose by giving an increased number of fractions of size <2Gy, given over 6–7wk (hyperfractionation without acceleration), have not shown any benefit.
- However, the CHART regimen has shown significant benefits, compared with conventional fractionation, and is recommended for use in the UK:
  - 54Gy in 36 fractions over 12 days
  - gave a 9% survival advantage at 2y, compared with 60Gy in 30 fractions, in a UK trial in stages I–III NSCLC
  - costs of this treatment included inconvenience for patients and staff, increased acute toxicity with grade 3 in 20%, but no increase in late toxicity
  - no trial has compared these regimes with shorter 4wk schedules (e.g. 55Gy in 20 fractions), which remain popular in the UK and have been used successfully in combination with concurrent chemotherapy (cisplatin and vinorelbine)
  - CHART is logistically difficult to deliver (treatment 8 a.m., 2 p.m., 8 p.m., including weekends) but is available in some UK centres
  - CHARTWEL, a modification of this regimen to exclude weekends, delivers 60Gy in 40 fractions over 17 days
  - however, this regimen has shown no survival benefit when compared with 66Gy in 33 daily fractions.

### *Treatment volume*

No randomized trials have examined what volume should be irradiated. The standard, in most of the world, was previously the 1° tumour and hilar and mediastinal lymph nodes, with a 1–2cm margin. Retrospective comparisons have not demonstrated any advantage over volumes encompassing the tumour and radiologically involved lymph nodes only. Typically, now the treatment volume is drawn on CT images, either fused with PET or using PET images for guidance, limiting the treatment to the 1° tumour and involved lymph nodes only. The treatment volume is best estimated by 4D imaging.

### *Chemo-radiation*

The Non-Small Cell Lung Cancer Collaborative Group overview suggested a 2% increase in 5y survival when cisplatin-based chemotherapy is added to radical radiotherapy. The Radiation Therapy Oncology Group (RTOG) 88–08 study reinforces these conclusions, with a 4y survival advantage of 5% with combined therapy.

Chemotherapy delivered synchronously with radiotherapy has recently been shown to improve survival in randomized trials, compared with sequential treatment. A meta-analysis of six trials involving 1205 patients with locally advanced NSCLC showed significant benefit with concomitant chemo-irradiation (3y survival of 23.8%, 5y survival of 15.1%), compared with sequential therapy (3y survival of 18.1%, 5y survival of 10.6%). Similar benefits were reported for RTOG 9410, and concurrent chemo-radiotherapy has become standard in the UK for good PS 0–1 with stages II–III unresectable NSCLC.

This approach does add to the toxicity, in particular oesophagitis, and these patients require careful review throughout the treatment, with at least one in five requiring support with NG feeding.

### **Recent developments**

- Long-term loco-regional control of NSCLC remains poor, even with intensive regimens, e.g. CHART.
- High risk of systemic relapse in patients in whom long-term control of the loco-regional disease is achieved.
- With improved 3D planning of radiotherapy using conventional (2Gy/fraction/day) fractionation, dose escalation with conformal therapy may be safely achieved.
- Hypofractionated high-dose radiotherapy (e.g. 66Gy/24 fractions) shows promise in this setting:
  - short-course treatment is less demanding on patients and treatment facilities
  - stereotactic radiotherapy, the logical extension of this approach, shows even greater promise for small inoperable tumours (e.g. 54Gy/three fractions or 55Gy/five fractions), with local control of >90% after 2y for stage I disease.
- As local control of loco-regional disease improves, relapse with metastatic disease becomes an increasing problem, in particular brain metastases:
  - trials of prophylactic cranial irradiation (PCI) are under way in patients receiving chemo-irradiation for stage III NSCLC.

### Post-operative radiotherapy

A meta-analysis of randomized trials of post-operative radiotherapy for completely resected NSCLC has shown impaired survival following irradiation in patients with N0 and N1 disease. However, there is evidence that radiotherapy affords an improvement in local control for patients with N2 disease. The best results have been reported with 50Gy in 25 daily fractions.

### Palliative radiotherapy

For many patients with advanced NSCLC, radiation therapy is a key component in alleviating symptoms from thoracic disease, in particular:

- haemoptysis
- chest pain
- cough
- large airway obstruction or stridor
- SVCO.

Radiotherapy can also improve systemic symptoms, such as anorexia and weight loss, and produces useful palliation for many metastatic sites, including lymph nodes, bone, brain, and soft tissue.

In the UK, MRC trials have shown equivalent survival and symptom control for patients with a poor performance status treated with one-, two-, and ten-fraction regimes, establishing the shorter courses as the treatment of choice for symptom control in advanced NSCLC, particularly in patients with PS 2–3. However, these short schedules are associated with chest pain and flu-like symptoms in up to 40% of patients. A transient reduction in peak expiratory flow rates may occur. Most patients receiving the two-fraction regimen suffer from at least moderate, but short-lived, oesophagitis.

Another MRC trial has shown that higher-dose palliative therapy (39Gy in 13 daily fractions) offers a modest survival advantage for patients with a good performance status with locally advanced NSCLC, compared with two fractions, but at the cost of greater toxicity, in particular oesophagitis. The selection of an appropriate radiotherapy regimen requires individual assessment.

### Outcomes of radiotherapy treatment

The key prognostic factors are the TNM staging and the patient's performance status. When these are controlled for, treatment-related factors, such as the chemotherapy and radiotherapy dose, can provide modest survival benefits.

#### Radical radiotherapy

- Stages I–II, 5y survival of 20–30%, significantly better with stereotactic radiotherapy.
- Stage III, chemotherapy plus radiotherapy, 2y survival of 25%, 5y survival of 15%.

#### Palliative radiotherapy

- Median survival in MRC trials of short-course radiotherapy of 6mo, 4mo in patients with a poor performance status.
- After high-dose palliative radiotherapy (39Gy/13 fractions)—median survival of 9mo, 1y survival of 36%, 2y survival of 12%.



# Small-cell lung cancer

## Introduction

- SCLC accounts for 15–20% of all lung cancers.
- Its treatment is quite distinct from that of NSCLC because:
  - almost all SCLCs demonstrate rapid growth and early dissemination
  - >90% have systemic disease at presentation
  - surgery is inappropriate in the vast majority—<10% are operable
  - chemotherapy is the key 1° treatment and has an important impact on survival.

## Staging and prognostic factors

A much simplified staging system has been used for SCLC, as the vast majority of patients were initially treated with chemotherapy, irrespective of the disease extent. A two-stage system was drawn up by the Veterans Administration Lung Group:

- limited-stage disease—tumour confined to one hemithorax and regional lymph nodes and can be covered by tolerable radiotherapy fields
- extensive-stage disease—disease beyond these bounds.

Within these broad categories, subgroups may be defined, according to one or more of the following prognostic factors:

- performance status
- sex (♀ have better prognosis)
- lactate dehydrogenase (LDH)
- alkaline phosphatase
- Serum sodium ( $\text{Na}^+$ ) (hyponatraemia carries a poor prognosis).

However, a recent review of the staging of SCLC has shown prognostic value for the application of the current TNM classification (see <https://cancerstaging.org> to download the TNM staging), which is now recommended for all lung cancers.

## Chemotherapy for small-cell lung cancer

Prior to the introduction of systemic treatment with chemotherapy in the 1970s, the outlook for patients diagnosed with this disease was dreadful, with a median survival of 6wk for patients with extensive disease and 3mo for those with limited disease. Combination chemotherapy leads to an objective response in the majority, with improved survival times, and is now the standard 1° treatment for both stages of disease.

### Principles of treatment

- Etoposide plus cisplatin or carboplatin (EP or ECarb, respectively) has been established as the best first-line treatment (see Table 13.6).
- These regimens have demonstrated superior response rates and tolerability, compared with older anthracycline regimens, e.g. cyclophosphamide, doxorubicin, vincristine (CAV).
- Etoposide platinum chemotherapy is compatible with concomitant thoracic irradiation, which is now standard therapy for non-metastatic SCLC.
- Standard chemotherapy treatment comprises 4–6 cycles of EP or ECarb.
- No benefit from maintenance treatment or increased dose intensification or high-dose chemotherapy.
- The disease is reassessed by CXR in each cycle and by CT scan at the end of chemotherapy.
- During chemotherapy, the particular risks are:
  - neutropenic sepsis—prophylactic broad-spectrum antibiotics, e.g. ciprofloxacin, may reduce the risk of serious infection. Greatest risk in patients with poor performance status
  - DVT and thromboembolic disease.
- Objective response rate in 80% of all patients:
  - complete responses in 30–40% of patients with limited-stage disease, 10–20% with extensive disease.
- Despite this, most patients relapse after chemotherapy only.
- Consolidation radiotherapy to the chest can reduce the risk of relapse in some patients, particularly those with limited disease and complete response to chemotherapy.
- High risk of CNS relapse after chemotherapy, and this can be reduced by PCI.

### Specific problems of small-cell lung cancer

- Poor performance status:
  - unlike NSCLC, patients with PS 2–3 may benefit from chemotherapy, if previously fit and deterioration is due to recent rapid tumour progression.
- SVCO is relatively common with locally advanced right-sided central tumours/mediastinal lymphadenopathy:
  - initial treatment with chemotherapy is appropriate for most and leads to prompt resolution of SVCO in the majority.
- Paraneoplastic syndromes are not uncommon:
  - e.g. SIADH, ectopic ACTH, neuromuscular syndromes.

- Elderly patients:
  - 25% of patients with SCLC are >70 years
  - there is good evidence to support the use of 1° chemotherapy in these patients if there are no other contraindications to treatment.
- CNS disease at presentation—chemotherapy may be given as initial treatment in fit patients or after initial cranial radiotherapy.

### Second-line chemotherapy

This cancer can remain chemosensitive at relapse after 1° chemotherapy ± radiotherapy. Treatment options with response rates of around 20% include:

- CAV
- topotecan
- taxanes.

Despite the chemosensitivity of this disease, only limited progress has been made with regard to long-term survival after relapse (see Table 13.7).

Currently, clinical trials are evaluating the potential benefits of, e.g.:

- drugs that interfere with autocrine growth factor loops and signal transduction pathways
- angiogenesis inhibitors
- tumour vaccines.

**Table 13.6** Commonly used combination regimens in SCLC

EP	Etoposide	100mg/m <sup>2</sup> IV days 1–3 q 3wk
	Cisplatin	60–80mg/m <sup>2</sup> IV day 1 q 3wk
ECarb	Etoposide	100mg/m <sup>2</sup> IV days1–3 q 3wk
	Carboplatin	AUC 5–6 IV day 1 q 3wk
CAV	Cyclophosphamide	1000mg/m <sup>2</sup> IV day 1 q 3wk
	Doxorubicin	50mg/m <sup>2</sup> IV day 1 q 3wk
	Vincristine	2mg/m <sup>2</sup> IV day 1 q 3wk

**Table 13.7** Outcome of chemotherapy for SCLC

Stage of disease	Median survival (months)	1y survival (%)	3y survival (%)
Limited	18–24	50–70	20–30
Extensive	8–10	20	
Relapsed <sup>a</sup>	6		

<sup>a</sup> Limited to patients who remain fit to receive chemotherapy for relapsed disease.

## Radiotherapy for small-cell lung cancer

### Background

- The 1° treatment for most patients with SCLC is combination chemotherapy:
  - >90% have systemic disease (either overt or microscopic) at presentation
  - highly chemosensitive disease.
- However, many patients with SCLC benefit from radiotherapy:
  - highly radiosensitive disease
  - post-chemotherapy irradiation of the thorax (TI) improves the relapse-free and overall survival of patients with localized disease
  - concomitant chemo-radiotherapy is now standard treatment for non-metastatic SCLC, with significant improvement in survival rates
  - palliative radiotherapy is an effective treatment in patients relapsing after, resistant to, unfit for, or refusing chemotherapy.

### Thoracic irradiation

- 60% of relapses after chemotherapy are in the thorax.
- TI reduces the risk of loco-regional recurrence by 50% and improves survival by 5% at 3y in limited-stage disease.
- The optimum schedule remains uncertain (see Table 13.8).
- Conventionally, treatment is restricted to patients with limited-stage disease who have a complete, or good partial, response to chemotherapy.
- The target volume includes all sites of the disease at presentation.
- Mediastinal lymph nodes traditionally were irradiated, even if of normal size, because of the high risk of microscopic involvement.
- Currently, the best results reported are with radiotherapy delivered early, and concurrently, with chemotherapy, and directed at the 1° and involved lymph nodes only.
- Concurrent chemo-irradiation poses certain problems:
  - no way of restricting treatment to chemotherapy responders
  - increased toxicity, in particular, oesophagitis, which may require NG tube feeding.

**Table 13.8** Thoracic irradiation—examples of treatment regimens

Timing of radiotherapy	Dose (Gy)	Number of fractions	Fractions/day
Post-chemotherapy	50	25	1
	40–45	15	1
Concomitant with cycle 1 or 2 of chemotherapy	45	30	2
	50–66	25–33	1

### Prophylactic cranial irradiation

- SCLC has a high propensity for brain metastases:
  - 20% have brain involvement at diagnosis
  - 80% have brain involvement at death.
- The blood–brain barrier limits access of chemotherapy to the CNS, which is a so-called ‘sanctuary site’.
- The outlook for CNS disease is very poor:
  - only 50% achieve palliation with treatment with chemotherapy or radiotherapy
  - the median survival is only 3mo.
- Because of these risks and the radiosensitivity of SCLC, prophylactic cranial radiotherapy has been evaluated since the 1980s.
- Low-dose PCI halves the risk of brain metastases in patients in complete remission after chemotherapy, with a 5% improvement in 3y survival.
- PCI is recommended in patients for whom TI is appropriate, but it is given at the end of chemotherapy in an effort to minimize CNS toxicity.
- The optimum treatment regimen is uncertain.
- Examples include 25–30Gy/ten fractions.
- Following PCI, 30% of patients complain of somnolence 2–3mo after treatment, which is self-limiting.

### Palliative radiotherapy

- A short course of irradiation to either the 1° tumour or metastases can provide useful symptom control, even in frail patients.
- The choice of dose and radiation schedule is similar to that used in NSCLC, using the lowest effective dose and number of fractions.
- In most situations, a single fraction or up to five fractions of treatment are appropriate and effective.

### Recent advances in small-cell lung cancer management

- PCI has now been shown to provide benefit in patients with both limited- and extensive-stage disease.
- Dose escalation is being explored for TI, with 3D conformal radiotherapy limited to the 1° tumour and lymph nodes >1cm at presentation.
- TI may also have benefits following chemotherapy for extensive-stage disease.

## Surgery for small-cell lung cancer

### Introduction

- Historically, surgical resection has not generally been considered for SCLC, as systemic relapse rates were high. However, the use of neoadjuvant and adjuvant therapies has led to a change in BTS and NICE guidelines.
  - NICE guidelines (2011) suggest considering surgery in patients with early-stage SCLC (T1–2a, N0, M0) disease.

### Principles of surgery

The preoperative assessment, surgical techniques, and post-operative management of SCLC should follow the same pathways as for NSCLC.

### Further reading on lung cancer

- Aupérin A, Le Péchoux C, Rolland E, et al. (2010). Meta-analysis of concomitant versus sequential radiochemotherapy in locally advanced non-small-cell lung cancer. *J Clin Onc* **28**, 2181–90.
- Herbst RS, Heymach JV, Lippman SM (2008). Lung cancer. *N Engl J Med* **359**, 1367–80.
- Kwak EL, Bang YJ, Camidge DR, et al. (2010). Anaplastic lymphoma kinase inhibition in non-small cell lung cancer. *N Engl J Med* **363**, 1693–703.
- Lim E, Baldwin D, Beckles M, et al.; British Thoracic Society; Society for Cardiothoracic Surgery in Great Britain and Ireland (2010). Guidelines on the radical management of patients with lung cancer. *Thorax* **65** Suppl 3, iii1–27.
- Lynch TJ, Bell DW, Sordella R, et al. (2004). Activating mutations in the epidermal growth factor receptor underlying responsiveness of non-small cell lung cancer to gefitinib. *N Engl J Med* **350**, 2129–39.
- National Institute for Health and Care Excellence (2011). Lung cancer: the diagnosis and treatment of lung cancer. *Clinical guideline* 121. Available at: <http://guidance.nice.org.uk/cg121>.
- Non-small Cell Lung Cancer Collaborative Group (1995). Chemotherapy in non-small cell lung cancer: a meta-analysis using updated data on individual patients from 52 randomised clinical trials. *BMJ* **311**, 899–909.
- Rueth NM, Andrade RS (2010). Is VATS lobectomy better: perioperatively, biologically and oncologically? *Ann Thorac Surg* **89**, 2107–11.



## Mesothelioma

Malignant pleural mesothelioma (MPM) is an aggressive tumour arising from the serosal lining of the chest and characterized by poor survival rates, irrespective of treatment.

### Epidemiology

- Rare, 2543 cases in 2010 in the UK.
- Incidence expected to rise in the next decade and fall thereafter.
- Peak age 60–70y.
- ♂:♀ ratio 5:1.

### Aetiology

- Caused by asbestos exposure in the vast majority.
- 90% have an occupational history of exposure; high risk in, e.g. builders, shipyard workers.
- Non-occupational exposure leads to increased risk in the partners of these at-risk workers, e.g. washing their overalls.
- All types of asbestos fibre are implicated.
- Prolonged latent period after exposure, so that the clinical presentation is often 30–40y later.
- Rarely caused by other agents:
  - erionite fibres (Turkey)
  - thorium dioxide.

### Prevention

Recognition of the hazards of asbestos and improved protection of workers at risk should result in a falling incidence of mesothelioma after 2020.

### Pathology

- Mesothelioma arises from the parietal or visceral pleura, grows diffusely within the pleural space, commonly associated with pleural effusion, and often leads to encasement of the lung by a solid tumour.
- The tumour invades directly into the lung and mediastinum and may cross the diaphragm to involve the peritoneum.
- Metastatic spread to other organs, e.g. the liver in advanced disease.
- Malignant mesothelioma has three distinct histological subtypes:
  - epithelioid (around 50%)
  - sarcomatous
  - mixed.
- Malignant tumours may be localized or diffuse and are more commonly associated with asbestos exposure and symptoms such as chest pain and dyspnoea.
- Differentiation from other intrathoracic malignancies, such as pulmonary adenocarcinoma or metastatic pleural disease, requires the assistance of an experienced pathologist.
- 1° mesothelioma of the peritoneum is rare, associated with heavy exposure and ingestion of asbestos.



## Clinical presentation

- Late presentation is common, with only an insidious development of the classic symptoms:
  - non-pleuritic chest pain
  - dyspnoea
  - systemic symptoms of fatigue, weight loss, sweating, and fever.
- Physical examination frequently demonstrates finger clubbing and signs of pleural effusion or solid pleural tumour. Signs of advanced disease may include:
  - a palpable chest wall mass
  - hoarse voice, vocal cord palsy
  - SVCO
  - Horner's syndrome
  - ascites due to extension of the tumour into the peritoneum.

Occasionally, early disease, which is asymptomatic, is picked up on CXR for another cause.

## Investigations

- Laboratory results in mesothelioma are usually unremarkable.
- No serological tumour marker reproducibly identified.
- Radiological appearances are often non-specific:
  - pleural effusion/thickening on CXR
  - 20% have associated pulmonary fibrosis (asbestosis)
  - CT scan demonstrates the extent of pleural mass and effusion, and encasement of the lung
  - MRI provides superior definition of the tissue planes, e.g. in mediastinal or transdiaphragmatic extension.
- Histological diagnosis should be obtained in the majority of cases, using the least invasive technique:
  - ultrasound- or CT-guided biopsy
  - thoracoscopy and biopsy (80% positive)
  - each of these procedures carries a small risk of implantation of the tumour in the chest wall.

## Staging

The TNM classification (see <https://cancerstaging.org> to download the TNM staging) is not commonly used, but staging is vital if patients are considered for surgery. The Brigham staging system (see Table 13.9) provides an alternative straightforward method, based on key disease characteristics, that stratifies survival.

Accurate preoperative pathological staging is best achieved by thoracoscopy for pleural evaluation, mediastinoscopy for mediastinal nodal involvement, and laparoscopy to rule out peritoneal seeding or diaphragmatic involvement, when indicated.

## Management

Without treatment, the average patient with MPM survives <1y from the time of diagnosis. Patient selection is crucial, and all patients should be discussed at a thoracic MDT meeting.

**Table 13.9** Brigham staging system for MPM

Stage	Description
I	Disease completely resected within the capsule of the parietal pleura without adenopathy; ipsilateral pleura, lung, pericardium, diaphragm, or chest wall disease limited to previous biopsy sites
II	All of stage I, with positive resection margins and/or intrapleural adenopathy
III	Local extension of disease into the chest wall or mediastinum, heart, or through the diaphragm into the peritoneum; or with extra-pleural lymph node involvement
IV	Distant metastatic disease

### *Surgery*

- Resection may be considered for patients with stage I disease, who are medically fit.
- Patients with stage II disease and selected individuals with stage III mesothelioma may be suitable for resection, as part of a multi-modality therapy regimen if clear margins can be obtained.
- It has been suggested that only patients with epithelioid-type mesothelioma be offered resection due to poor outcome of the sarcomatoid and mixed varieties.
- For those suitable for resection, radical surgery with extra-pleural pneumonectomy (EPP) is the standard procedure.
- Lung-sparing cytoreductive surgery may be an alternate option, but long-term data are currently lacking.
- Hyperthermic intraoperative pleural cisplatin may improve the interval to recurrence and survival.
- Parietal peritonectomy is now being considered for intraperitoneal disease, although the benefit is uncertain.

### *Pleurodesis*

Talc pleurodesis is effective in many patients in delaying the reaccumulation of the pleural effusion.

### *Radiotherapy*

- Short-course palliative radiotherapy for painful chest disease/masses.

### *Chemotherapy*

- Objective responses in 10–20% of patients with advanced disease treated with, e.g. cisplatin, carboplatin, ifosfamide, mitomycin.
- Improved results are reported with the anti-folate pemetrexed, in combination with cisplatin or carboplatin (response rate of 20–40%), with a median survival of 12mo.

### *Palliative care*

Symptom control is often difficult, in particular, pain and dyspnoea, and early involvement of specialist palliative care services may be beneficial.

## Compensation and notification

Patients may be entitled to claim compensation in two ways:

- a claim for Industrial Injuries Disablement Benefit from the Department of Social Security (via Benefits Agency)
- a common law claim for damages from the firm/firms where exposure to asbestos occurred.

All deaths of patients with mesothelioma must be notified to the coroner (procurator fiscal in Scotland).

## Treatment outcome

- The overall median survival is poor—8–14mo.
- Better prognosis with epithelioid pathology.
- Single-centre results from Boston US in carefully selected patients undergoing radical surgery, followed by chemotherapy and radiotherapy, are better, particularly in patients in whom early disease is excised with clear pathological margins:
  - median survival of 17mo
  - 2y survival of 36%
  - 5y survival of 14%.

## Further reading

- British Thoracic Society Standards of Care Committee (2007). BTS statement on malignant mesothelioma in the UK, 2007. *Thorax* **62** Suppl 2, ii1–ii19.
- Pistolesi M, Rusthoven J (2004). Malignant pleural mesothelioma. *Chest* **126**, 1318–20.
- Robinson BWS, Musk AW, Lake RA (2005). Malignant mesothelioma. *Lancet* **336**, 379–408.
- Sugarbaker DJ, Flores RM, Jaklitsch MT, et al. (1999). Resection margins, extrapleural nodal status and cell type determine postoperative long-term survival in trimodality therapy of malignant pleural mesothelioma: results in 183 patients. *J Thorac Cardiovasc Surg* **117**, 54–63.
- Sugarbaker DJ, Gill RR, Yeap BY, et al. (2013). Hyperthermic intraoperative pleural cisplatin chemotherapy extends interval to recurrence and survival among low-risk patients with malignant pleural mesothelioma undergoing surgical macroscopic complete resection. *J Thorac Cardiovasc Surg* **145**, 955–63.
- Yan TD, Brun EA, Cerruto CA, Haveric N, Chang D, Sugarbaker PH (2007). Prognostic indicators for patients undergoing cytoreductive surgery and perioperative intraperitoneal chemotherapy for diffuse malignant peritoneal mesothelioma. *Ann Surg Oncol* **14**, 41–9.

## Thymic tumours

Tumours derived from the thymus (thymomas) comprise ~20% of all mediastinal tumours and are the commonest tumour in the anterior mediastinum (less common pathologies include lymphoma and teratoma).

### Epidemiology

Thymomas occur at any age but are rare before the age of 20 and peak between 40 and 60y, with similar frequency in both sexes. The incidence varies somewhat in different countries, being more frequent in the Far East. The average in Europe is around 0.5 new cases per year per 100 000.

### Aetiology

The cause is unknown.

### Pathology

Most thymomas are slow-growing 'low-grade' malignant tumours. It is believed that they derive from epithelial elements, but the tumours retain the capacity for the production of T-cells. The T-cells are generally of normal phenotype.

According to the relative abundance of epithelial and lymphocytic cells, histological subgroups have been described:

- epithelial
- lymphocytic
- mixed.

These cellular characteristics have no clear influence on the prognosis. In contrast, the gross appearance of the resected tumour is related to the clinical prognosis. The presence or absence of an intact capsule is of key importance, and local invasion remains the most consistent factor in predicting outcome.

The following classification is of practical benefit:

- encapsulated thymoma (50%)—benign cytology and biological behaviour
- invasive thymoma (40%)—benign cytology, but capable of local invasion and, rarely, distant metastasis
- thymic carcinoma (10%)—demonstrates cytological and biological features of cancer.

However, recurrent disease can occur after complete excision of a histologically bland thymoma. Metastatic spread can involve the pleura, lung, lymph nodes, and other viscera.

### Clinical presentation

- 30% diagnosed with an asymptomatic mediastinal mass.
- 40% have local symptoms, e.g. chest pain, cough, dyspnoea, SVCOC.
- 30% have paraneoplastic syndromes, most associated with an immunological phenomenon.

- Myasthenia gravis is the commonest paraneoplastic effect; occurs in 15–25% of patients with thymoma:
  - autoantibodies target acetylcholine receptor
  - 10–25% of patients with myasthenia have a thymoma.
- Red cell aplasia occurs in 5% of thymomas:
  - in 30%, low platelets or low white cell count (WCC) also
  - 30–50% of patients with red cell aplasia have a thymoma.
- Hypogammaglobulinaemia occurs in 5–10% of thymomas.

### Investigations

- Imaging by CT or MRI is essential to stage and plan therapy.
- No specific tumour markers.
- CT-guided core biopsy preferred to FNA cytology.

### Management and staging

#### Surgery

- 90% present with localized disease, for which surgery is the preferred treatment.
- Thymectomy is performed through a median sternotomy, although bilateral anterolateral thoracotomy, with transverse sternotomy (clam shell approach), is better for advanced tumours.
- Video-assisted thoracoscopic approaches are increasingly used, but long-term survival/recurrence data are lacking.
- Modern surgical techniques allow complete resection of invasive thymomas, including lung resection, SVC removal, and reconstruction, where applicable.
- Complete resection provides long-term survival in excess of 90% for stages I and II disease.
- Incomplete resection provides less survival benefit in the order of 30–50%.
- No adjuvant therapy is indicated for stage I disease, but radiotherapy may be of benefit in patients with stages II/III disease who have positive margins.

#### Staging (Masaoka)

- Staging of the disease is based on the surgical findings and radiology:
  - I—tumour confined within the intact capsule, with no microscopic invasion
  - II—macroscopic growth into the mediastinal fat tissue or pleura, or microscopic capsular invasion
  - III—macroscopic invasive growth into the surrounding organs, pericardium, great vessels, or lung
  - IV—disseminated disease
  - IVa—pleural or pericardial metastasis
  - IVb—lymph node or blood-borne metastasis.

#### Radiotherapy

- Post-operative radiotherapy is recommended for stages II and III, where excision has been incomplete, and for local recurrence of thymoma:
  - 50–66Gy in 25–33 fractions.

**Chemotherapy**

- Malignant thymoma is chemosensitive, with objective response rates in advanced disease of 40–60%.
- Most regimens include an anthracycline and cisplatin, e.g. CAP (cyclophosphamide, doxorubicin, and cisplatin).
- Indications for chemotherapy include:
  - metastatic disease
  - bulky recurrent disease
  - recurrence post-radiotherapy
  - preoperative treatment of locally advanced disease.

**Treatment outcomes**

- OS rates are good (see Table 13.10).
- Patients with autoimmune disorders, such as myasthenia, are diagnosed with relatively small tumours.
- However, thymectomy leads to remission in paraneoplastic syndromes in only 30–50%.
- Patients with persistent symptoms, e.g. myasthenia, require ongoing medical treatment with anti-cholinesterases and/or immunosuppressants.

**Table 13.10** Treatment outcomes for thymoma

Stage of disease	Recurrence rate (%)	10y survival (%)
I	4	88
II	14	70
III	26	57
IV	46	38

**Further reading**

Lee HS, Kim ST, Lee J (2007). A single institutional experience of thymic epithelial tumours over 11 years: clinical features and outcome and implications for future management. *Br J Cancer* **97**, 22–8.

Tomaszek S, Wigle DA, Keshavjee S, Fischer S (2009). Thymomas: review of current clinical practice. *Ann Thorac Surg* **87**, 1973–80.

## Surgery for pulmonary metastatic disease (metastasectomy)

Resection of isolated pulmonary metastases has been in practice for sarcomas of soft tissue and bone for some 40y, but it is now increasingly requested for other pathologies such as colorectal cancer. Perhaps surprisingly, there have been no clinical trials to evaluate the benefits of such an approach. From the considerable historical data available, several principles are clear:

- the best results are achieved after resection of solitary metastasis following a long DFS
- for bone and soft tissue sarcoma, 5y survival rates of 34% and 25%, respectively, are reported after the first metastasectomy
- all cases should be discussed at the relevant MDT meeting, and it is mandatory to confirm that the 1° tumour is currently controlled and the pulmonary metastatic disease can be feasibly completely resected
- preoperative staging usually comprises CT of the chest and imaging of the 1° site and other potential metastatic sites, usually by FDG-PET
- wedge resection is the most frequently performed procedure, either open or by videothoracoscopy
- pathologies currently considered for such procedures include metastases from colorectal cancer, soft tissue and bone sarcomas, renal cancer, germ cell malignancy, melanoma, and breast, head and neck, lung, and gynaecological cancers
- multiple and bilateral metastatic deposits may be resected, but the anticipated benefit of surgery declines, particularly when surgery requires to be repeated for recurrent metastatic disease after a short interval
- Patients for whom surgery is felt to be unsafe because of comorbidities or previous therapy, may be considered for nonsurgical radical therapy with either stereotactic radiotherapy or RFA.

### Further reading

Treasure T, Fiorentino F, Scarci M, Moller H, Utlely M (2012). Pulmonary metastasectomy for sarcoma: a systematic review of reported outcomes in the context of Thames Cancer Registry data. *BMJ Open* 2, e001736.





# Breast cancer

- Introduction 262
- Epidemiology 264
- Genetics of breast cancer 266
- Pathology 270
- Breast cancer screening 274
- Presentation and staging 278
- Management of non-invasive (*in situ*) breast cancer 280
- Management of early invasive breast cancer 282
- Loco-regional radiotherapy 285
- Adjuvant systemic therapy 286
- Management of locally advanced breast cancer 290
- Management of metastatic breast cancer 292
- Management of male breast cancer 296
- Prognosis 297

## Introduction

Much effort has been invested in this, the most common solid tumour occurring in women. The study of breast cancer has rewarded us with lessons in the application of many aspects of oncology, including:

- population screening
- medical genetics
- organ conservation and reconstruction
- adjuvant therapy
- meta-analyses
- clinical guidelines.

The benefits of this industry are now visible, with a significant fall in breast cancer deaths over the last 20y.



## Epidemiology

### Key facts about breast cancer

- The commonest ♀ cancer in Europe and the US.
- 31% of all malignancies in women in the UK.
- The incidence is increasing by 1% per year.
- The rate of increase is increasing, especially in low-risk populations.
- The lifetime risk in the UK is 1 in 8 women.
- The risk of breast cancer correlates with the income per capita.
- In the UK, 49 961 new breast cancers diagnosed in 2010.
- Currently, 11 600 breast cancer deaths per year.
- Since the 1980s, UK breast cancer mortality has fallen by about 20%, in response to improvements in diagnosis and treatment.
- ♂ breast cancer is rare—397 cases in 2010 in the UK.

### Aetiology

Several risk factors have been identified by epidemiological studies.

#### Age

- Breast cancer is very rare before the age of 20y and rare below 30y.
- The incidence of breast cancer doubles every 10y until the menopause.
- After 50y, the rate of increase slows and in some countries plateaus.

#### Geography

- 7-fold variation in the incidence between high- and low-risk countries.
- Low rates in the Far East.
- Migrants from low-incidence countries assume the risk in the host country within two generations.

#### Age at menarche and menopause

- Early menarche and late menopause increase the risk.
- Ovarian ablation before 35y reduces the risk of breast cancer by 60%.
- Menopause after the age of 55y doubles the risk.

#### Age at first pregnancy

- Nulliparity and late age at first pregnancy increase the risk.
- A woman whose first pregnancy is at 30y has double the risk of breast cancer, compared with first pregnancy at <20y.

#### Family history

- Genetic predisposition accounts for around 10% of ♀ breast cancers, and 20% of ♂.

#### Exogenous oestrogens

- Use of oral contraceptives for >4y before first pregnancy increases the risk of pre-menopausal breast cancer.
- The use of unopposed oestrogens in HRT for 10–15y is associated with an increase in breast cancer.
- Combined HRT preparations also increase the risk, but the magnitude of the effect is uncertain.
- Prenatal exposure to diethylstilboestrol increases the risk in women over 40y of age.

### *Diet*

- Associations have been shown with high dietary fat intake, obesity, and alcohol consumption.

### *Benign breast disease*

- Previous breast surgery for severe atypical epithelial hyperplasia is associated with a 4-fold increase in risk.

### *Radiation*

- Exposure to ionizing radiation at an early age, e.g. treatment of Hodgkin's disease.
- Mammographic screening is associated with a decrease in breast cancer deaths, but the effects of screening younger women (<50y) are uncertain.

### *Male breast cancer*

- Peak incidence 10y later than in women.
- It may occur in association with Klinefelter's syndrome.

## Genetics of breast cancer

- ~5% of ♀ breast cancer is due to the inheritance of a mutated copy of either *BRCA1* or *BRCA2*.
- Women who inherit a mutated copy of either gene have an elevated lifetime risk of breast cancer—45–65% develop breast cancer by the age of 70y.
- Particular risk of pre-menopausal breast cancer, often before the age of 40y.
- Associated risk of ovarian cancer (greater with *BRCA1*).
- ♂ carriers are at risk of prostate cancer and, for *BRCA2* carriers, breast cancer.
- Some ethnic groups are at particular risk for carriage of these mutations (estimated 2% of US Ashkenazi Jews).
- Other genes contribute less often to familial breast cancer:
  - hypothesized that ataxia–telangiectasia heterozygotes are at risk, but this is as yet unproven
  - risk associated with mutation in *PTEN* (Cowden disease), *MSH1* or *MSH2* (HNPCC), and *p53* (Li–Fraumeni syndrome).
- The recent findings of the large-scale Collaborative Oncological Gene–environment Study (COGS) have identified 41 new loci associated with an overall risk of breast cancer, bringing the total of such loci to 76 at present.
- It is likely that these findings will lead to an improved assessment of the risk of breast cancer in individual women through the estimation of a polygenic risk score and should also assist in the management of breast cancers by providing further genetic information to assist in the subclassification of this heterogeneous disease.

The management of hereditary breast cancer is essentially that of non-hereditary disease. Less clear is how to manage asymptomatic ♀ members of these families and the contralateral breast of the index cases. Published guidelines define groups of women at moderate and high risk, recommending referral to medical genetic clinics for the latter group for counselling, advice on risks, consideration of testing for mutations of *BRCA1* and *BRCA2*, and referral for appropriate further management. Women at moderate risk are offered annual mammography and review in a breast clinic between ages 40 and 50y.

Currently, the following options are open to women at moderate and high risk.

### Prophylactic surgery

- Bilateral s/c mastectomy (usually with immediate reconstruction) reduces the incidence of breast cancer in these women, but its impact on survival is uncertain. This reduces the risk of breast cancer by 95% (not 100%).
- May be offered in conjunction with prophylactic oophorectomy.

### Screening

- MRI has been shown to be superior to mammography in women under 50y at high risk of breast cancer because of their family history.

- Annual MRI of both breasts recommended for:
  - carriers of mutated *BRCA1* or *BRCA2* aged 30–50y
  - carriers of mutated *p53* aged >20y
  - women with a 10y risk of breast cancer of >8% from age 30–39y
  - women with a 10y risk of breast cancer of >20% from age 40–49y.
- Annual mammography of both breasts is also recommended for carriers of mutated *BRCA1* or *BRCA2* or *p53* aged 40–49y.

### Breast cancer prevention trials

- Four clinical trials of tamoxifen have demonstrated that this drug reduces the incidence of ER-positive breast cancer by about 50%.
- NICE guidance on familial breast cancer in 2013 includes the use of tamoxifen in the prevention of ER-positive breast cancer.

### Risk assessment for women with a family history of breast cancer (examples)

Women at population risk—<3% develop breast cancer aged 40–50y, <17% lifetime risk:

- only one first- or second-degree relative with breast cancer diagnosed aged <40y, and
- no family history of bilateral breast cancer, ovarian cancer, ♂ breast cancer.

Women at moderate risk—3–8% develop breast cancer aged 40–50y, 17–30% lifetime risk:

- only one first-degree relative with breast cancer diagnosed <40y, or
- one first-degree relative with ♂ breast cancer, or
- one first-degree relative with bilateral breast cancer diagnosed <50y, or
- two first-degree relatives with breast cancer at any age, or
- one first- or second-degree relative with breast cancer at any age and one first- or second-degree relative with ovarian cancer, or
- three first- or second-degree relatives with breast cancer at any age.

Women at high risk—>8% develop breast cancer aged 40–50y, 30% lifetime risk:

- two first-degree relatives with breast cancer diagnosed aged <50y, or
- three first- or second-degree relatives with breast cancer aged <60y, or
- four first- or second-degree relatives with breast cancer at any age, or
- one relative with ovarian cancer and a first- or second-degree relative on the same side with breast cancer aged <50y, or
- two relatives with ovarian cancer, or
- one relative with bilateral breast cancer aged <50y.

**Further reading**

Bahcall OG (2013). iCOGS collection provides a collaborative model. *Nat Genet* **45**, 343.

National Institute for Health and Care Excellence (2013). Familial breast cancer: classification and care of people at risk of familial breast cancer and management of breast cancer and related risks in people with a family history of breast cancer. *Clinical guideline* 164. London: NICE. Available at: <http://www.nice.org.uk/guidance/cg164>.

Ore S (2008). Who should have breast magnetic resonance imaging evaluation? *J Clin Oncol* **26**, 703–11.

Turner NC, Jones AL (2008). Management of breast cancer—part I. *BMJ* **337**, a421.

Turner NC, Jones AL (2008). Management of breast cancer—part II. *BMJ* **337**, a540.





## Pathology

- Breast cancer is commoner in the left breast.
- Around 50% arise in the upper outer quadrant.
- The commonest pathology is ductal carcinoma.
- See Table 14.1 for histological types.

### Ductal carcinoma *in situ*

- 90% of breast carcinomas arise in the ducts of the breast.
- Begins as an atypical proliferation of the ductal epithelium that eventually fills and plugs the ducts with neoplastic cells.
- As long as the tumour remains within the confines of the ductal basement membrane, it is classified as ductal carcinoma *in situ* (DCIS).
- Localized DCIS is impalpable but often visible on mammography as an area of microcalcification; the vast majority of DCIS therefore presents through the breast screening programme.
- Not all DCIS will inevitably progress, but the probability of development of invasive cancer is estimated at 30–50%.
- Currently, trials are being set up to try to give a better understanding to the natural history of DCIS and to establish biomarkers for disease progression.

### Lobular carcinoma *in situ*

- These pre-invasive lesions carry a risk not only of ipsilateral invasive lobular carcinoma, but also of contralateral breast cancer.
- Typically are neither palpable nor contain microcalcification.

### Invasive ductal carcinoma

- This accounts for 75% of breast cancers.
- The malignant cells are associated with a fibrous stroma that can be dense (scirrhous carcinoma).
- The tumour invades through the breast tissue into the lymphatics and vascular spaces, to gain access to the regional nodes (axillary and, less often, internal mammary) and systemic circulation.
- Systemic spread can involve almost any organ, but most commonly the bone, lung or pleura, liver, skin, and CNS.
- The histological grade (I–III) of the tumour is assessed from three features and predicts the tumour behaviour. The features are:
  - tubule formation
  - nuclear pleomorphism
  - mitotic frequency.
- ER and PR status is commonly assessed by immunocytochemistry.
- Other biological markers (e.g. HER2) are of value both as a predictor of prognosis and as a guide to therapy, assessed by immunocytochemistry or FISH.

### Oestrogen receptor-positive breast cancer

- 60–70% of breast cancers express the nuclear ER.
- This dependence on natural sex hormones to control tumour growth conveys a better prognosis, compared with ER-negative tumours which have a higher risk of spread to lymph nodes and distant sites at presentation.

### *HER2-positive breast cancer*

- Amplification of the growth factor receptor gene *HER2* occurs in 25–30% of breast cancers.
- Associated with aggressive behaviour, high risk of lymph node involvement, and haematogenous spread.

### *Triple negative breast cancer*

- These tumours do not express ER, PR, or HER2.
- Account for 15% of breast cancers.
- Commoner in pre-menopausal women and in association with *BRCA1*.
- Most express EGFR.
- Paradoxical high risk of early relapse, but relative sensitivity to chemotherapy.

## Ductal carcinoma of special type

A number of pathological variants are identified, with relatively good prognosis, namely medullary carcinoma, tubular carcinoma, and mucinous carcinoma. Paget's disease of the breast is ductal carcinoma of the ducts with involvement of the skin of the nipple and areola. All have an underlying invasive ductal carcinoma.

## Invasive lobular carcinoma

Lobular carcinomas account for 5–10% of breast cancers. About 20% develop contralateral breast cancer. Unusual patterns of spread are recognized, including the propensity for spread to the peritoneum, meninges, ovaries, and uterus.

**Table 14.1** Histological types of breast malignancy

- Invasive ductal carcinoma:
  - no special type
  - combined with other type
  - medullary carcinoma
  - mucinous carcinoma
  - Paget's disease.
- Invasive lobular carcinoma.
- Mixed lobular and ductal carcinoma.
- Sarcoma (various).
- Lymphoma.
- Metastases (e.g. breast cancer, SCLC).

**Gene expression profiling**

Three gene expression-based prognostic cancer tests are licensed for the prediction of prognosis and treatment benefit for women with early-stage breast cancer. Two use real-time reverse transcriptase polymerase chain reaction (RT-PCR) to examine gene profiles of 21 and 70 genes; the third uses DNA microarray technology to evaluate two genes. All require pathological review of specimens to check the tumour content and evaluate the RNA quality. Such approaches should pave the way to the individualization of therapy for women with breast cancer, but, at present, further clinical trials are ongoing to clarify how best such assays be integrated into standard clinical practice.



## Breast cancer screening

- There have been at least seven RCTs of mammographic screening over the last 40y.
- The Health Insurance Plan (HIP) study of New York and the Two Counties Study from Sweden both showed a 30% reduction in mortality in the >50-year-old age group who were screened with mammography.
- A meta-analysis of all the published trials confirms a significant benefit for the over 50s.
- None of the trials published so far have shown a mortality benefit for women under the age of 50y.
- Two meta-analyses report a 14%, but non-significant, reduction in mortality in younger women.
- A recent review of the UK breast screening programme has clarified concerns with regards to the number of patients treated for breast cancer which would not have caused health problems.
- It is estimated that, for every 235 women invited for screening, one breast cancer death will be prevented, representing 43 breast cancer deaths prevented per 10 000 women aged 50 invited to screening for the next 20y.
- Against this, 19% of breast cancers diagnosed in women invited for screening would not have caused problems if left undiagnosed and untreated (129 per 10 000 women).
- It is generally agreed that the benefits of screening outweigh the harms.

### Imaging modality

- The aim of screening for breast cancer is to identify pre-invasive disease or invasive disease before dissemination (through the lymphatics or blood).
- No evidence that simple breast self-examination is an effective means of screening for breast cancer.
- X-ray mammography is the most sensitive technique for detecting breast cancer and is also the most specific.
- Mammography is most sensitive, once involution of the breast tissue has occurred (i.e. post-menopausal women).
- Mammography is less sensitive in women with dense breasts—i.e. those with predominantly glandular tissue or residual stromal tissue.
- Breast ultrasound, useful for assessment of focal abnormalities, is also useful in detecting impalpable lesions.
- Ultrasound examination of axillary lymph nodes may reveal abnormal nodes in the presence of suspected breast cancer.
- Telediaphanography (infrared scanning of the breast tissue) has both low sensitivity and low specificity for malignancy and is not used routinely.
- MRI with dynamic IV contrast is a very sensitive technique, but variable specificity has been reported. It has a role in young women with a family history of breast cancer.

### Mammographic technique

- The breast is compressed to flatten the breast tissue to reduce movement, overlapping shadows, and radiation dose.
- The uniform thickness of the tissue improves the image quality and contrast.
- Low-energy radiation is passed through the breast, resulting in a high-contrast image.
- The image is digitally recorded, with display on a high-resolution computer screen.
- Two views of each breast are performed—one in the lateral oblique position diagonally across the chest, the other in the cranio-caudal position.
- Compression of breast tissue lasts only a few seconds, but 7% of women find the examination very painful, and a large proportion find it uncomfortable.

### Radiation dose

- Low radiation dose (72mGy per examination).
- The radiation risk is 1–2 excess cancers per million women screened after a latent period of 10y in the post-menopausal age group but is higher in women under 30y.
- Dose to the breast 75 times that of a CXR.

### Organization of the UK breast screening programme

In the UK, women aged 50–70y are invited, through their GP, to attend either a breast screening centre or a mobile van for mammography every 3y. Women aged over 70y are not routinely called for screening but are encouraged to make their own appointments at breast screening units every 3y.

Currently, the age group for screening is being extended to 47–73y between 2010 and 2016 in England.

The mammograms are read by a consultant radiologist (double reading is now the usual practice). If an abnormality is seen that is thought to be suspicious, the woman is recalled to an assessment clinic at the breast screening centre. A clinical examination is performed at the recall visit, with further X-rays, an ultrasound examination, and a core biopsy, if appropriate. Women diagnosed with cancer are referred promptly to a breast surgeon who will arrange appropriate treatment.

- An average of 77% of women accept the invitation to be screened.
- 4% of women are recalled for further tests.
- 7.8 cancers per 1000 women screened are found.
- A rigorous quality control system monitors the performance in all breast screening centres annually.

**Interval cancers**

These are cancers that occur in the interval between two screening episodes. They fall into five categories:

- *true interval cancer*—appears in the 3y interval and was not present on the previous screening mammogram
- *false negative*—the lesion was present on the previous screening mammogram
- *technical*—cancer was not on the film due to its position
- *mammographically occult*—cancer is not visualized on either the screening mammogram or at the time of diagnosis
- *unclassifiable*—no mammogram taken at the time of diagnosis.

There are an estimated 5.5 interval cancers per 10 000 women screened in the first year after screening, 11.3 in the second, and 12.2 in the third.

- Many European countries offer screening every 2y.

**Screening for high-risk groups**

- Women at moderate to high risk of breast cancer because of their family history should be offered annual breast MRI between ages 40 and 50y.

**Features of screen-detected breast cancer**

The reduction in breast cancer deaths resulting from mammographic screening is attributed to:

- the diagnosis and effective treatment of asymptomatic pre-invasive disease (DCIS)
- the diagnosis and effective treatment of early invasive breast cancer, which would otherwise not present until systemic spread had occurred.

A number of studies have found good evidence to support this, including the following observations:

- 10–20% of screen-detected lesions are non-invasive
- >30% of screen-detected invasive cancers are <10mm
- <20% are grade 3
- 70–80% node-negative.

**Further reading**

Independent UK Panel on Breast Cancer Screening (2012). The benefits and harms of breast cancer screening: an independent review. *Lancet* **380**, 1778–86.

Moss SM, Cuckle H, Evans A, Johns L, Waller M, Bobrow L; Trial Management Group (2006). Effect of mammographic screening from age 40 years on breast cancer mortality at 10 years' follow-up: a randomised controlled trial. *Lancet* **368**, 2053–60.

NHS Breast Screening Programme. Available at: <http://www.cancerscreening.nhs.uk/breast-screen/index.html> (accessed November 2012).

Nyström L, Andersson I, Bjurstram N, Frisell J, Nordenskjöld B, Rutqvist LE (2002). Long-term effects of mammography screening: updated overview of the Swedish randomised trials. *Lancet* **359**, 909–19.

Van Goethem M, Tjalma W, Schelfont K (2006). Magnetic resonance imaging in breast cancer. *Eur J Surg Oncol* **32**, 901–10.





## Presentation and staging

The most common presentations of breast cancer include the following (see Table 14.2):

- abnormal screening mammogram:
  - now accounts for around 25% of cases
  - microcalcification, mass lesion, distortion
- breast lump or thickening
- axillary tumour
- breast skin changes—dimpling, puckering, erythema
- nipple changes—inversion, discharge, rash (Paget's disease)
- persistent breast tenderness or pain
- infrequently, symptoms from metastatic disease, e.g. bone pain, spinal cord compression
- worrying symptoms are highlighted by the GP's 'red flag' referral letter (breast lump, ulceration or retraction of the skin, eczema or retraction of the nipple) and should be seen within 2wk.

### Investigations

The diagnosis of breast cancer is made by 'triple assessment':

- full clinical examination:
  - including calliper measurement of any lump in either breast, and clinical assessment of the tumour, including fixity to the adjacent skin and pectoral muscle
  - lymphadenopathy, in particular the axillae and SCF (although clinical assessment of the axillary lymph nodes correlates poorly with the pathological spread to the nodes). If nodes are palpable, FNA cytology should be done with ultrasound guidance
- bilateral mammography, usually combined with ultrasound examination of the breast lesion and axilla
- core biopsy of suspicious breast lesions:
  - impalpable lesions will require stereotactic or ultrasound-guided FNA or biopsy
  - core biopsy is the preferred diagnostic test, avoiding the risk of false positive cytology and allowing the differentiation between CIS and invasive cancer in the majority. Core biopsy can also provide valuable prognostic information, such as the tumour grade and receptor status, which may be valuable in planning treatment.

This combined approach to assessment has >90% sensitivity and specificity.

- In a few cases where there is still uncertainty, excision biopsy of the breast lesion may be required. This is now unusual.
- Preoperative assessment of the axilla by ultrasound-guided FNA cytology of enlarged or abnormal lymph nodes is recommended, to allow appropriate axillary treatment.
- No serum tumour markers have been found to be useful.
- In the absence of locally advanced disease (see Table 14.2) or symptoms/signs of metastatic disease, routine radiological staging investigations, such as CXR, bone scan, or CT scan, have not been found to be of benefit.

### TNM staging system

Changes have been made in the staging system to take account of improvements in the pathological assessment of this disease. Pathological assessment of the extent of disease may differ considerably from clinical staging. See  <https://cancerstaging.org> to download the TNM staging.

**Table 14.2** Indications for referral to breast clinic

- Screen-detected breast cancer.
- Breast lump:
  - any new discrete lump
  - new lump in pre-existing nodularity
  - asymmetrical nodularity persisting after menstruation
  - abscess/inflammation which does not settle after one course of antibiotics
  - persistent or recurrent cyst.
- Pain:
  - associated with a lump
  - intractable pain that interferes with the patient's life and fails to respond to simple measures (well-supporting bra, simple analgesics, abstinence from caffeine, evening primrose oil)
  - unilateral persistent pain in post-menopausal women.
- Nipple discharge:
  - in any woman aged >50y
  - in younger women if bloodstained, persistent single duct, or bilateral, sufficient to stain clothes.
- Nipple retraction, distortion, or eczema.
- Change in breast contour.

## Management of non-invasive (*in situ*) breast cancer

DCIS and lobular carcinoma *in situ* (LCIS) are rarely symptomatic, although extensive pre-invasive disease may present with a mass or thickening of breast tissue. The former is often diagnosed during screening.

### Management options

#### Simple mastectomy

- *In situ* breast cancer was rarely diagnosed before the advent of mammographic screening.
- The standard treatment until the 1980s was mastectomy.
- Following mastectomy, relapse rates are very low (2–3%).
- Loco-regional recurrence and metastatic disease are attributed to undiagnosed micro-invasive cancer.
- Axillary surgery/staging is not routinely indicated because of the low risk of positive nodes. If the DCIS is multifocal and widespread, sentinel lymph node biopsy (SLNB) should be offered.
- Mastectomy remains the standard treatment for large *in situ* cancers and for multifocal disease (with breast reconstruction, if desired).

#### Wide excision alone

- With the increased diagnosis of small localized non-invasive cancers by mammographic screening, breast-conserving surgery has been adopted for the majority. Because the lesion is usually screen-detected and impalpable, the lesion (often microcalcification) is localized first by the radiologist. A specimen X-ray is essential to ensure complete excision of the abnormality.
- Cavity wall shavings to exclude residual disease are increasingly routine.
- However, 20–30% develop local recurrence within 5y.
- The highest risk of recurrence is with high-grade DCIS and excision margin involved or <1mm clear—excision margin of at least 2mm is now recommended.
- Half of the recurrences are non-invasive, but the rest contains invasive cancer.

#### Wide excision and post-operative radiotherapy

- Three large randomized studies have now confirmed the benefit of radiotherapy in this setting.
- The whole breast is irradiated.
- Risk of recurrence of <10% at 5y.
- The majority of patients are treated with radiotherapy following breast-conserving surgery for DCIS, with the exception of patients with small foci of low-grade DCIS excised with wide resection margins.

#### Adjuvant hormone therapy

- Results of two large clinical trials are contradictory.
- Tamoxifen 20mg daily, taken for 5y, reduces the frequency of recurrence of DCIS by about 30%, but there is uncertainty with regard to the recurrence of invasive cancer.
- Clinical trials with aromatase inhibitors are ongoing.

Most breast specialists now view LCIS as a marker of increased risk for developing breast cancer, rather than as a precursor lesion like DCIS. It is generally managed by excision only, and clear resection margins are not generally required for these reasons. All patients with a diagnosis of LCIS, whether on core biopsy or excision biopsy, are followed up with mammographic surveillance.

For all patients with early breast cancer, the key to selection of the optimum treatment is multidisciplinary discussion, including radiology, pathology, surgery, and oncology input. Appropriate treatment options can then be presented to the patient to help them decide their individual preference.

### Further reading

- Barnes NLP, Bundred NJ (2007). Treatment of ductal carcinoma in situ. In: Dixon JM, ed. *Breast surgery*, 3rd edn. Edinburgh: Elsevier, pp. 149–66.
- Van la Parra RF, Ernst MF, Barneveld PC, Broekman JM, Rutten MJ, Bosscha K (2008). The value of sentinel lymph node biopsy in ductal carcinoma in situ (DCIS) and DCIS with microinvasion of the breast. *Eur J Surg Oncol* 34, 631–5.

## Management of early invasive breast cancer

Early breast cancer is defined as disease that can be completely removed by surgery, i.e. T1–3, N0–1 tumours. The management of this disease comprises the following:

- surgical treatment of the breast and axilla
- pathological assessment and staging to direct adjuvant therapy
- adjuvant therapy:
  - chemotherapy
  - radiotherapy
  - endocrine therapy
- follow-up.

Again, multidisciplinary discussion and planning of treatment are essential to optimize treatment outcomes.

- Consensus guidelines do not recommend routine staging investigations such as CXR, liver ultrasound, bone scan, or CT imaging of the chest and abdomen.
- However, individuals at high risk of metastatic disease should be identified by the MDT and imaged accordingly.
- Similarly, breast MRI can improve loco-regional staging in selected cases.

### Breast surgery

- All patients require complete removal of the 1° tumour by either wide local excision or mastectomy.
- Halsted mastectomy was the operation most extensively applied to breast cancer patients during the first half of the twentieth century, but it has gradually been replaced by a variety of less radical operations.
- Simple mastectomy and axillary node dissection (AND) is a less mutilating operation, preserving the pectoralis major muscle and its neurovascular bundle. Seroma and numbness of the axillary skin are common sequelae. Lymphoedema may also be seen in around 16–28% of cases.
- Quadrantectomy, introduced at the beginning of the 1970s, is a breast-conserving operation that removes the 1° cancer with a margin of 2.0cm of normal breast tissue. Infrequently performed now because of poor cosmesis.
- Wide local excision removes the tumour mass with a limited margin of normal tissue (0.5–1cm)—this is now the most commonly performed procedure for early breast cancers but must be followed by radiotherapy to prevent local recurrence.
- Breast-conserving surgery alone was followed by local recurrence of breast cancer in up to 30% of patients.
- Several large randomized trials comparing breast-conserving surgery followed by breast radiotherapy with mastectomy alone have demonstrated similar local control rates and survival.
- Wide local excision, followed by breast irradiation, is the preferred treatment for the majority of T1–2 breast cancers.
- A wide variety of specialist oncoplastic surgical techniques can be used for resecting tumours where there is a relatively high tumour-to-breast

volume and can optimize aesthetic outcomes, following breast-conserving surgery. These techniques have been demonstrated to be oncologically safe, with local recurrence rates comparable to those of 'conventional' breast-conserving surgery.

- Breast conservation may not be appropriate, e.g.:
  - multifocal disease
  - large tumour in a small breast
  - where breast irradiation would be contraindicated
  - recurrent tumour after previous breast-conserving surgery and radiotherapy.
- Some patients simply prefer mastectomy, not least because of the possible avoidance of radiotherapy (not always).
- Irrespective of the choice of local treatment, it should result in a local recurrence rate of <10% after 10y follow-up.
- Patients where breast-conserving surgery is not technically possible, due to tumour size, may be candidates for neoadjuvant systemic therapy. Chemotherapy has been shown to be effective in downstaging tumours and increasing rates of breast-conserving surgery when given preoperatively. It has also been shown to be equally as effective as adjuvant treatment, in terms of DFS and OS.
- Breast reconstruction can be offered after mastectomy, either at the time of 1° surgery or at a later date—transverse rectus abdominis muscle (TRAM) flap, latissimus dorsi flap, and implants all have a role. These are well described by Cordeiro (2008). Generally, 1° (immediate) reconstruction is best carried out either by a plastic surgeon or increasingly by a full-time oncoplastic breast surgeon.
- Patients with Paget's disease are usually best served with a mastectomy, due to the risk of occult *in situ* or invasive disease within the breast and the high risk of in-breast recurrence following breast conservation.

### Axillary surgery

- Clinical assessment of axillary nodes is inaccurate; palpable mobile lymphadenopathy is associated with reactive lymph node changes as commonly as metastasis.
- At least 30% of positive nodes are impalpable.
- Ultrasound examination of the axilla and FNA cytology of abnormal nodes improves the accuracy of preoperative assessment.
- Aims of axillary surgery:
  - to provide pathological staging of axillary lymph nodes
  - to clear the axilla of disease in order to reduce the risk of uncontrolled axillary tumour.
- Axillary clearance:
  - completes staging of the axilla
  - provides regional control of the disease, unless the nodes are fixed or extracapsular spread of cancer beyond the lymph node
  - problem of overtreatment, particularly for small low-grade cancers with low probability of positive nodes—particularly in screen-detected disease.
  - side effects—lymphoedema, arm pain, stiff shoulder, sensory deficit. Must preserve the long thoracic nerve and thoracodorsal nerve.

- Sentinel lymph node biopsy (SLNB):
  - the aim is the identification and removal of the first draining lymph node for careful pathological examination
  - should allow node-negative patients to avoid axillary clearance
  - sentinel node-positive patients may then be treated by axillary clearance (usually) or axillary radiotherapy (less often)
  - dye and radiolabelled colloid injected in the peri-areolar region (usually both techniques together are used)
  - any blue-stained node or nodes with radioactivity count >10 times the background are excised (there may be >1 sentinel node)
  - several trials have demonstrated the advantages of SLNB over axillary node sampling and clearance. There is less morbidity, but there is a definite learning curve. SLNB is now routinely used in the management of women with breast cancer with clinically and radiologically negative axillae
  - the role of frozen sections, touch imprint cytology, or molecular methods to assess the sentinel lymph node intraoperatively are currently being evaluated
  - the prognostic impact of isolated tumour cells (<0.2mm) and micrometastases (>0.2mm and <2mm) in the sentinel node is controversial—the former is currently considered node-‘negative’, and the latter node-‘positive’ and may require chemotherapy
  - the recent American College of Surgeons Oncology Group randomized trial examined the role of completion AND following positive SLNB and found no additional survival or regional recurrence benefit in women undergoing AND. However, this trial is controversial due to the debate about the extent of axillary radiotherapy used. A more recent European trial examined the same issue in women with sentinel lymph node micrometastases and similarly found no benefit from completion AND. This remains a controversial issue, and the UK POSNOC trial is currently being established to attempt to provide further data on the management of the positive sentinel node.

### Further reading

- Cordeiro PG (2008). Breast reconstruction after surgery for breast cancer. *N Eng J Med* **359**, 1590–601.
- Fitoussi AD, Berry MG, Fama F, et al. (2010). Oncoplastic breast surgery for cancer: analysis of 540 consecutive cases. *Plast Reconstr Surg* **125**, 454–62.
- Galimberti V, Cole BF, Zurrada S, et al. (2013). Axillary dissection versus no axillary dissection in patients with sentinel-node micrometastases (IBCSG 23-01): a phase 3 randomised controlled trial. *Lancet Oncol* **14**, 297–305.
- Giuliano AE, Hunt KK, Ballman KV, et al. (2011). Axillary dissection vs no axillary dissection in women with invasive breast cancer and sentinel node metastasis. A randomised clinical trial. *JAMA* **305**, 569–75.
- Rastogi P, Anderson SJ, Bear HD, et al. (2008). Preoperative chemotherapy: updates on National Surgical Adjuvant Breast and Bowel Project Protocols B-18 and B-27. *J Clin Oncol* **26**, 778–85.
- Salem AA, Douglas-Jones AG, Sweetland HM, Mansel RE (2006). Intraoperative evaluation of axillary sentinel lymph nodes using touch imprint cytology and immunohistochemistry. Part II. Results. *Eur J Surg Oncol* **32**, 484–7.
- Zavagno G, Del Bianco P, Koussis H, et al. (2008). Clinical impact of false-negative sentinel lymph nodes in breast cancer. *Eur J Surg Oncol* **34**, 620–5.



## Loco-regional radiotherapy

- Breast irradiation reduces the risk of local recurrence after breast-conserving surgery from about 30% to <10% at 10y.
- In addition to the 75% reduction in the local recurrence rate, it is estimated that, for every four local recurrences prevented, one cancer-related death at 10y is avoided.
  - Breast irradiation is recommended for all patients after wide local excision for invasive breast cancer.
  - The whole breast is treated with tangential fields to a dose of 40Gy in 15 fractions (or an equivalent dose fractionation regimen).
  - Care taken to minimize the volume of the lung and heart irradiated; most centres now using CT planning.
  - Boost of 10–15Gy is commonly delivered to the tumour bed, using electrons or <sup>192</sup>Ir implant.
  - Post-operative irradiation of the breast now accounts for a large proportion of the work of most radiotherapy departments, and efforts are being made to reduce this.
  - Risk-adjusted strategies are under investigation, e.g. no radiotherapy in women >70y who have undergone wide local excision for ER-positive T1, N0 breast cancer.
  - Accelerated partial breast irradiation, e.g. high-dose-rate brachytherapy, IMRT, or IORT are also being assessed in clinical trials.
- Post-mastectomy radiotherapy to the chest wall reduces the risk of loco-regional recurrence:
  - recommended for patients with four or more positive axillary nodes and for patients with T3 disease
  - there is a modest survival benefit
  - trials are ongoing to determine the benefits of post-mastectomy radiotherapy in patients with 1–3 positive lymph nodes.
- Axillary radiotherapy:
  - certainly indicated after a lymph node sampling that is positive
  - generally should be avoided after axillary clearance because of the high risk of lymphoedema and brachial plexopathy
  - the SCF may be irradiated after axillary clearance if four or more nodes positive.

In general, radiotherapy should begin as soon as possible after surgery. However, enhanced normal tissue damage can result when radiotherapy and adjuvant chemotherapy are given together, and radiotherapy is often postponed until completion of chemotherapy.

## Adjuvant systemic therapy

Despite effective local therapy with surgery and radiotherapy, many women with 'early breast cancer' harbour occult micrometastases, and, if untreated, these give rise to overt metastatic disease, which leads to the eventual death of the patient. There is now a large body of evidence that effective systemic treatment directed against micrometastatic disease at the time of diagnosis of breast cancer conveys a significant survival benefit in the majority of women.

- The risk of micrometastatic disease correlates well with the recognized prognostic factors, simply summarized by the Nottingham prognostic index (NPI).
- Similarly, the potential gains from systemic therapy, in terms of improved survival, are greatest in patients with poor prognosis.
- There have been many trials amongst women with operable breast cancer, examining the effects of systemic treatment, either endocrine manoeuvres or chemotherapy or both, on the survival of these patients.
- The basis of all these therapies is the reduction or eradication of microscopic systemic metastatic disease in women in whom all macroscopic local tumour has been effectively removed.
- In 1992, the Early Breast Cancer Trialists' Collaborative Group published an overview of 133 randomized trials involving 75 000 women with early breast cancer.
- This has had major impact, setting standards of care for adjuvant therapy for this disease, with regular revisions published to keep pace with clinical research.
- It was most recently updated in 2011, with a meta-analysis of 100 000 women treated within 123 adjuvant chemotherapy trials.

### Adjuvant chemotherapy

(See Table 14.3.)

Combination chemotherapy reduces recurrence rates and mortality by approximately one-third in all groups of women. This results in an absolute gain in DFS and OS which is greatest in women at high risk.

- Age <50y:
  - node-negative, 5.7% increase in 10y survival
  - node-positive, 12.4% increase in 10y survival.
- Age 50–69y:
  - node-negative, 6.4% increase in 10y survival
  - node-positive, 2.3% increase in 10y survival.
- Chemotherapy should therefore be considered in all, but very good prognosis in pre-menopausal breast cancer and in post-menopausal women with intermediate or poor prognosis breast cancer.
- In the 1980–90s, 'standard' adjuvant regimens included 6mo of CMF (cyclophosphamide, MTX, fluorouracil) or 12wk of AC (Adriamycin® (doxorubicin), cyclophosphamide).
- Similar benefits from the shorter anthracycline regimen, but this was unsuitable for some patients with, e.g. past history of cardiac disease.
- In 2006, positive results established the epirubicin CMF regimen as the new standard for the UK, with a 7% improvement in 5y survival, compared with 6mo treatment with CMF (82% versus 75%).

- Similar benefits were seen with six 4wk cycles of CAF or CEF.
- Addition of a taxane to anthracycline adjuvant chemotherapy also provides further modest benefit.
- HER2-positive breast cancer has a relatively poor prognosis, despite adjuvant chemotherapy, but several large cooperative trials have demonstrated significant survival benefits when the monoclonal antibody trastuzumab is given, in addition to adjuvant chemotherapy.
- Clinical trials with trastuzumab have helped to address some questions, including:
  - the optimum duration of adjuvant therapy appears to be 12mo
  - the optimal timing is to deliver trastuzumab after anthracycline chemotherapy is complete, but trastuzumab can be given along with non-cardiotoxic cytotoxics, e.g. docetaxel
  - cardiotoxicity with anthracyclines can be avoided using regimens such as carboplatin/docetaxel/trastuzumab.
- Estimates of benefit from adjuvant chemotherapy with different regimens may be calculated for individual patients, available via [www.adjuvantonline.com](http://www.adjuvantonline.com).

**Table 14.3** Examples of adjuvant chemotherapy regimens

<b>CMF six cycles over 24wk</b>			
Cyclophosphamide	100mg/m <sup>2</sup> PO or 600mg/m <sup>2</sup> IV	Days 1–14 Days 1 and 8	q 4wk q 4wk
MTX	40mg/m <sup>2</sup> IV		
Fluorouracil	600mg/m <sup>2</sup> IV	Days 1 and 8	q 4wk
<b>AC four cycles over 12wk</b>			
Doxorubicin	60mg/m <sup>2</sup>	Day 1	q 3wk
Cyclophosphamide	600mg/m <sup>2</sup>	Day 1	
<b>EpiCMF eight cycles over 28wk</b>			
Epirubicin then	100mg/m <sup>2</sup>	q 3wk	4 cycles
CMF	As above	q 4wk	4 cycles
<b>FEC six cycles over 24wk</b>			
Fluorouracil	500mg/m <sup>2</sup> IV	Days 1 and 8	q 4wk
Epirubicin	60mg/m <sup>2</sup> IV	Days 1 and 8	q 4wk
Cyclophosphamide	75mg/m <sup>2</sup> PO	Days 1–14	q 4wk
<b>FEC three cycles, followed by docetaxel three cycles over 18wk</b>			
<b>FEC as above, followed by:</b>			
Docetaxel	100mg/m <sup>2</sup>	Day 1	q 3wk
<b>TAC 6 cycles over 18wk</b>			
Docetaxel	75m <sup>2</sup>	Day 1	q 3wk
Doxorubicin	75mg/m <sup>2</sup>	Day 1	
Cyclophosphamide	500mg/m <sup>2</sup>	Day 1	

**Adjuvant endocrine therapy**

- 60% of breast cancers are ER-positive.
- Adjuvant hormone therapy confers survival benefits in these patients, in some cases, greater than with chemotherapy.
- Toxicity is less than for chemotherapy, mainly menopausal symptoms.
- No benefit in ER-negative breast cancer.
- For pre-menopausal women, ovarian ablation after resection of early breast cancer provides a 10.6% improvement in 10y survival—node-negative 6.8%, node-positive 13%.
- Adjuvant tamoxifen, 20mg daily for 5y, improves survival in both pre-and post-menopausal women:
  - 10y survival improved by 5% in node-negative, 11% in node-positive patients
  - reduced risk of contralateral breast cancer and osteoporosis
  - however, risk of thromboembolic disease and increased incidence of endometrial cancer ( $\times 2.5$ )
  - recent results show continued benefit, in terms of reduced breast cancer recurrence rates, with 10y of tamoxifen, compared with 5y. These benefits clearly outweigh the increased risks of thromboembolic disease and endometrial carcinoma. Prolonged therapy is most appropriate in young pre-menopausal women with ER-positive cancer.
- Several clinical trials have shown aromatase inhibitors to be superior to tamoxifen as adjuvant therapy in post-menopausal women:
  - improved relapse-free survival
  - reduced risk of thromboembolic disease and endometrial cancer
  - however, the optimum duration of therapy remains uncertain.
- Endocrine therapy may result in long-term health problems in breast cancer survivors, e.g. osteoporosis, and efforts to prevent these are under investigation (routine bone densitometry, prophylactic bisphosphonate therapy).
- Interaction with chemotherapy:
  - tamoxifen, given simultaneously with chemotherapy, reduces its benefit
  - adjuvant hormone therapy should only be commenced after completion of chemotherapy.

**Neoadjuvant therapy**

1° chemotherapy or hormone therapy for operable breast cancer provides early systemic treatment and allows assessment of the response to treatment; by definition, this is impossible with adjuvant therapy. Its disadvantages are the delay in definitive local surgery and the risk of over-treatment with chemotherapy in the absence of pathological staging (e.g. post-menopausal, ER-positive, node-negative tumour).

Several large randomized trials (e.g. NSABP-B18 and B27) have shown no difference in survival when pre- and post-operative chemotherapy were compared. Preoperative treatment can downstage the 1° tumour and, in some women, facilitates breast-conserving surgery where mastectomy would otherwise be required.

Adjuvant and neoadjuvant therapy are compared in Table 14.4.

**Table 14.4** Comparison of adjuvant and neoadjuvant therapy

	Adjuvant therapy	Neoadjuvant therapy
Advantages	<p>Pathological staging available for patient selection</p> <p>Immediate surgical removal of all macroscopic disease</p>	<p>Tumour response is visible to both clinicians and patients</p> <p>Reduction in tumour volume can facilitate breast conservation</p> <p>Lack of response gives opportunity to change chemotherapy</p> <p>Response to chemotherapy is a predictor of long-term outcomes</p>
Disadvantages	<p>No visible benefit in individual patients</p> <p>No means of assessing efficacy of treatment regimen in individual patients</p> <p>Mastectomy required for many tumours &gt;3cm in diameter</p>	<p>Risk of overtreatment, particularly in low-risk post-menopausal women</p> <p>Disease progression may occur prior to surgery (clinical trials have shown this is a rare event)</p>

### Further reading

- Davies C, Pan H, Godwin J, et al. (2013). Long-term effects of continuing adjuvant tamoxifen to 10 years versus stopping at 5 year after diagnosis of oestrogen receptor-positive breast cancer: ATLAS, a randomized trial. *Lancet* **381**, 805–16.
- Early Breast Cancer Trialists' Collaborative Group (1992). Systemic treatment of early breast cancer by hormonal, cytotoxic or immune therapy—Parts I and II. *Lancet* **339**, 1–15, 71–85.
- Early Breast Cancer Trialists' Collaborative Group (1998). Tamoxifen for early breast cancer: an overview of the randomized trials. *Lancet* **351**, 1451–67.
- Early Breast Cancer Trialists' Collaborative Group (1998). Polychemotherapy for early breast cancer: an overview of the randomized trials. *Lancet* **352**, 930–42.
- Early Breast Cancer Trialists' Collaborative Group (2000). Favourable and unfavourable effect on long-term survival of radiotherapy for early breast cancer: an overview of the randomized trials. *Lancet* **355**, 1757–70.
- Early Breast Cancer Trialists' Collaborative Group (2005). Effects of chemotherapy and hormonal therapy for early breast cancer on recurrence and 15 year survival: an overview of the randomized trials. *Lancet* **365**, 1687–717.
- Early Breast Cancer Trialists' Collaborative Group (2011). Effect of radiotherapy after breast conserving surgery on 10 year recurrence and 15 year breast cancer death: meta-analysis of individual patient data for 10,801 women in 17 randomised trials. *Lancet* **378**, 1707–16.
- Early Breast Cancer Trialists' Collaborative Group (2012). Comparisons between different polychemotherapy regimens for early breast cancer: meta-analyses of long-term outcome among 100,000 women in 123 randomised trials. *Lancet* **379**, 432–44.
- National Institute for Health and Care Excellence (NICE) (2009). Early and locally advanced breast cancer: diagnosis and treatment. *Clinical guideline* 80. London: NICE. Available at: <http://www.nice.org.uk/guidance/cg80>.

## Management of locally advanced breast cancer

Locally advanced disease is defined by the presence of infiltration of the skin or the chest wall or fixed axillary nodes, i.e.:

- T4a–d
- N2–3.

The probability of metastatic disease is high (>70%), but long-term survival is possible, and the median survival of these patients exceeds 2y.

At presentation, in addition to mammography and core biopsy, staging investigations should include:

- CXR
- isotope bone scan
- liver ultrasound or CT scan—increasingly MRI is used for staging.

Local control of the tumour and the prevention of tumour fungation are of major importance to the quality of life of these women, irrespective of the presence of metastases. A combination of 1° systemic treatment and radiotherapy is commonly used.

Many of these patients are elderly and have indolent ER-positive disease that responds well to endocrine therapy. First-line therapy in this group should be with one of the aromatase inhibitors (anastrozole, letrozole, or exemestane), which have been shown to be superior to tamoxifen in advanced breast cancer. Following maximal response, radical radiotherapy is delivered to the breast, axilla, and SCF.

Younger patients and patients with ER-negative disease are treated with 1° chemotherapy, usually an anthracycline-based combination. In some patients with a good response to systemic treatment, surgery may be feasible, followed by loco-regional radiotherapy. Hormone therapy is started after chemotherapy for ER-positive tumours:

- pre-menopausal—ovarian suppression (LHRH agonist) and tamoxifen
- post-menopausal—aromatase inhibitor.

Promising results have been reported in HER2+ locally advanced breast cancer treated with 1° chemotherapy plus trastuzumab.



## Management of metastatic breast cancer

Between 15% and 20% of patients present with metastatic breast cancer, and currently around 50% of patients with operable breast cancer relapse with metastatic disease. Despite advances in the systemic treatment of breast cancer, metastatic breast cancer is incurable with current therapies. The principles of its management include the following:

- the aim of treatment is palliation
- however, 20% survive 5y, so key aims also include the extension of life and maintenance of its quality
- ER-positive bone disease commonly demonstrates an indolent growth, with prolonged survival
- ER-negative visceral disease has worse prognosis
- response to chemotherapy may be quicker than to hormone therapy, response to hormones often more durable
- common sites of spread include the lung and pleura, liver, bone, brain, lymph nodes, and skin
- rarer sites include the peritoneum (lobular carcinoma), choroid, and pituitary.

### Endocrine therapy

Treatment with tamoxifen, ovarian ablation, progestins, or aromatase inhibitors will provide an objective response or prevent disease progression in 50–60% of those with ER-positive tumours. It is preferred over chemotherapy in older patients and for non-visceral metastatic disease.

Disease that responds to endocrine therapy and then progresses has a 25% response rate with second-line treatment; the response rate to a third agent is 10–15%. Randomized studies now suggest that the first-line treatment with the best response rate and longest progression-free interval is not tamoxifen, but:

- pre-menopausal—ovarian suppression (LHRH agonist) plus tamoxifen
- post-menopausal—aromatase inhibitor (anastrozole, letrozole, or exemestane)
- these treatments are also effective in patients who relapse during or after adjuvant tamoxifen
- subsequent second-, third-, and fourth-line therapy with agents to which the patient has not been exposed previously can be of benefit:
  - megestrol acetate (progestin)
  - fulvestrant (anti-oestrogen).

### Chemotherapy

(See Table 14.5.)

Advanced breast cancer is moderately chemosensitive. Active agents include:

- anthracyclines (doxorubicin, epirubicin)
- alkylating agents (cyclophosphamide)
- anti-metabolites (fluorouracil, capecitabine, MTX, gemcitabine)
- taxanes (docetaxel, paclitaxel)
- vincas (vinorelbine)
- platinum complexes (carboplatin, cisplatin).



**Table 14.5** Examples of chemotherapy regimens for advanced breast cancer

<b>FAC</b>		
Fluorouracil	500mg/m <sup>2</sup>	3-weekly
Doxorubicin	50mg/m <sup>2</sup>	
Cyclophosphamide	500mg/m <sup>2</sup>	
<b>EC</b>		
Epirubicin	75mg/m <sup>2</sup>	3-weekly
Cyclophosphamide	600mg/m <sup>2</sup>	
<b>Taxanes</b>		
Docetaxel	75–100mg/m <sup>2</sup>	3-weekly
or		
Paclitaxel	175mg/m <sup>2</sup> , or 90mg/m <sup>2</sup>	3-weekly Weekly
<b>Other agents</b>		
Vinorelbine	25mg/m <sup>2</sup> days 1 and 8	3-weekly
Capecitabine	1250mg/m <sup>2</sup> PO bd	3-weekly
Trastuzumab	4mg/m <sup>2</sup> loading dose	Wk 1
	2mg/m <sup>2</sup>	Wk 2 onwards, weekly
	or	
	8mg/m <sup>2</sup> loading dose	Wk 1
	6mg/m <sup>2</sup> weekly	Wk 4 onwards, 3-weekly

Vinorelbine, capecitabine, and trastuzumab may be used as a single agent or in combination, e.g. with paclitaxel or docetaxel.

Combination chemotherapy is the preferred treatment for patients with visceral metastatic disease:

- the liver and lung, rather than soft tissue, pleura, and bone
- ER-negative tumours.

Combinations, such as FAC (fluorouracil, doxorubicin, cyclophosphamide), produce response rates of 40–60%, with a median TTP of around 8mo. Despite the toxicity of such combinations (alopecia, nausea, mucositis, lethargy, myelosuppression), clinical trials have shown that the QoL of women improves, as they respond to treatment. Patients who have previously received anthracycline-based adjuvant chemotherapy may be treated with a taxane instead when they develop metastatic disease.

Following disease progression, 25–50% of women respond to second-line chemotherapy, e.g. with a taxane. In patients who remain fit for further chemotherapy, third- and fourth-line treatments may result in tumour response. Treatment options include capecitabine, vinorelbine, gemcitabine, and eribulin (a novel spindle poison).

Although phase II studies have suggested that high-dose chemotherapy may produce durable remissions from metastatic breast cancer, no survival benefit has yet been proven for such treatment.

### **Targeted therapy**

#### *Trastuzumab*

Between 25% and 30% of breast cancers overexpress HER2, a growth factor receptor associated with poor-prognosis disease. Trastuzumab is a recombinant mAb against HER2, administered IV weekly or 3-weekly. This drug has significant benefits in the treatment of HER2-positive advanced breast cancer, either as a single agent after failure of other chemotherapy regimens (response rate of 10%) or, more effectively, in combination with chemotherapy. When trastuzumab is given in combination with taxanes in the first-line treatment of metastatic breast cancer, it improves both the response rate and survival time. However, a combination with anthracyclines is contraindicated because of cardiotoxicity. Similar promising results are reported with trastuzumab in combination with other cytotoxics, e.g. capecitabine.

#### *Lapatinib*

In patients refractory to trastuzumab, the receptor TKI lapatinib, which inhibits EGFR and HER2, has shown positive results, in combination with capecitabine.

#### *Other agents*

A variety of growth factor receptor TKIs and anti-angiogenesis agents are under investigation in the setting of metastatic breast cancer refractory to conventional endocrine therapy. The mTOR inhibitor everolimus, given in combination with exemestane, improves the progression-free interval, compared with exemestane alone, in patients with hormone receptor-positive advanced breast cancer previously treated with non-steroidal aromatase inhibitors.

### **Radiotherapy**

Low-dose radiotherapy (e.g. 20Gy/five fractions) provides effective palliation for:

- painful bone metastases
- soft tissue disease
- spread to the brain or choroid.

### **Bisphosphonates**

These drugs have important roles in patients with bone metastases from breast cancer:

- treatment and prevention of malignant hypercalcaemia
- healing of osteolytic metastases
- reducing bone pain
- delaying the progression of bone disease, with reduced requirement for radiotherapy and reduced fractures.

Prolonged treatment is recommended, starting from the time of diagnosis of bone metastases and continuing even in the face of progressive disease.

Osteonecrosis of the jaw (ONJ) is a rare, but serious, toxicity of bisphosphonates, particularly when given continuously over a long period for metastatic disease, and may be precipitated by dental extractions. Ongoing trials are exploring:

- prophylactic treatment with these agents, hoping to prevent the future development of bone metastases in women with high-risk early breast cancer
- monitoring biomarkers of bone turnover, such as collagen cross-links, to determine the optimum frequency/dose/duration of therapy.

#### *Bisphosphonates for bone metastases from breast cancer*

- Zoledronate, 4mg—15min IV infusion, 4-weekly.
- Pamidronate disodium, 90mg—2h IV infusion, 4-weekly.
- Ibandronic acid, 6mg—2h IV infusion, 4-weekly.
- Ibandronic acid, 50mg—PO daily.
- Sodium clodronate, 1600mg—PO daily.

#### **Further reading**

National Institute for Health and Care Excellence (NICE) (2009). Advanced breast cancer: diagnosis and treatment. *Clinical guideline* 81. London: NICE.

## Management of male breast cancer

♂ breast cancer is rare, accounting for only 1% of all breast cancers. Although frequently diagnosed with advanced disease in older patients (median age 60–70y), stage for stage, the prognosis is similar to women. The pathology is the same, although 85% demonstrate ER positivity, and HER2 overexpression is uncommon (probably only 5%). Presentation is most commonly with a subareolar solid mass, nipple retraction, or bleeding from the nipple.

Staging of ♂ breast cancer mirrors the TNM system described earlier, and, for many patients, the appropriate 1° treatment is mastectomy and either SLNB or axillary clearance. Post-mastectomy radiotherapy is recommended for local disease control in patients with large 1° tumours (T3 or 4) and/or involved lymph nodes (N2 or 3).

Adjuvant tamoxifen is given to all men with ER-positive breast cancer for 5y, and adjuvant chemotherapy should be considered, again in similar fashion as in women, most frequently using anthracycline combinations (FAC or FEC). No proven benefit has been shown with other adjuvant endocrine therapies, in particular aromatase inhibitors.

The treatment of metastatic breast cancer in men is determined by the presence or absence of ERs and the sites of disease, in particular whether these are bone/soft tissue only or visceral, the latter potentially requiring initial chemotherapy for a prompt response. A number of endocrine therapies have shown benefit in men who develop progressive disease after initial response to tamoxifen, and these include LHRH agonists, progestins, androgens, and aromatase inhibitors. The range of cytotoxic therapies appropriate for visceral metastases and for metastatic disease progressing after endocrine therapy is identical to that used in women. In men with breast cancer which overexpresses HER2, trastuzumab therapy should also be considered.

## Prognosis

Table 14.6 summarizes the 10y survival rates, according to the stage of the disease at presentation. Although many women with metastatic breast disease survive 5y, despite progress in all aspects of treatment, this stage of the disease remains incurable.

**Table 14.6** Treatment outcomes: breast cancer survival rates

Stage	10y survival (%) <sup>a</sup>
0	>95
I	75–95
IIA	45–85
IIB	40–80
IIIA	10–60
IIIB	0–35
IIIC	0–30
IV	0.5

<sup>a</sup> Wide range of survival rates, individual prognosis determined by the TNM stage, grade, ER status, and treatment, e.g. chemotherapy.



# Colorectal cancer

Introduction 300

Colorectal cancer: surgery 302

Adjuvant chemotherapy of colorectal cancer 304

Chemotherapy for advanced colorectal cancer 306

Radiotherapy in colorectal cancer 310

## Introduction

- Colorectal cancer is the fourth commonest cancer worldwide.
- Affects men and women almost equally.
- Environmental factors (diet) play a major role in the aetiology of the disease.
- A minority of cases (<8%) are associated with genetic predisposition syndromes such as FAP and HNPCC.
- Almost always adenocarcinoma.
- Loco-regional lymph nodes tend to be involved before the development of disseminated disease.
- In rectal cancer, there is also a propensity for the tumour to infiltrate laterally into the peri-rectal fat and lymph nodes.





## Colorectal cancer: surgery

- Surgery is the mainstay of curative therapy for colorectal cancer.
- Curative resection requires excision of the 1° tumour and its lymphatic drainage, with an enveloping margin of normal tissue.

### Preoperative preparation

- The precise site and local extent of the tumour should be known before laparotomy or laparoscopic resection. In the latter, the site of the tumour must be carefully marked with ink via the colonoscope before laparoscopic resection; knowledge of distant spread is helpful.
- Full colonoscopy or proctosigmoidoscopy and air-contrast barium enema (in the absence of obstruction or perforation) are required.
- The liver is imaged with CT and/or ultrasound examination; CT and endo-anal ultrasound imaging of the pelvis may offer additional information of the depth of invasion of rectal cancers. MRI of the pelvis to stage rectal cancer is useful and considered mandatory in some institutions.
- Perioperative antibiotics and thromboembolic prophylaxis are mandatory.

### Principles in primary resection

- The bowel segment and its lymphatic field are excised intact.
- If an anastomosis is planned, it is fashioned without tension, ensuring a good lumen, secure apposition, and good blood supply.
- Minimally invasive colon cancer surgery is now commonplace. Whilst there is a distinct learning curve, the benefits in the short term are proven, and long-term data show no adverse impact on survival.

### Rectal cancer

- Total excision of the mesorectum (TME) is considered essential. This involves removal of the rectum itself, together with a sleeve of surrounding tissue contained within the mesorectal fascia. This has been shown to reduce local relapse rates.
- A proximal limit of 5cm clearance and a distal limit of 2cm clearance are adequate. There is now increasing evidence that rectal cancer surgery should be done in high-volume units by specialists.

### Post-operative care

- There is now clear evidence that the routine use of the enhanced recovery programme leads to speedier recovery and (perhaps) fewer post-operative complications.

### Local excision

- Preoperative assessment with MRI and endo-anal ultrasound is essential.
- 5% of rectal cancers may be removed by non-radical transanal surgery. In specialized centres, transanal endoscopic microsurgery has a role in very selected patients.
- Particularly appropriate in small, low, well-differentiated cancers on the posterior wall.

- If the pathologist reports incomplete excision, spread through the rectal wall, or poorly differentiated carcinoma, radical surgery may be required to obtain local extirpation of the tumour, if the patient is fit.

### Surgery of recurrent cancer

- Local recurrence occurs most commonly in rectal cancer, usually outside the bowel lumen. This is less common with adequate TME. If investigations suggest that a recurrence is isolated and potentially resectable, further surgery should be considered.
- Patients with metastases confined to the liver that are potentially resectable should be carefully considered in the context of an MDT which includes a hepatobiliary surgeon, as there is up to 30% chance of cure in carefully selected cases. Laparoscopic liver resection of 2° is routine in specialized centres.
- Repeat liver resection of further colorectal 2° is helpful in selected patients. In a few centres, this is also being done laparoscopically.
- Resection of other 'solitary sites', such as the lung, may also have long-term benefits.

### Further reading

- Baatrup G, Elbrand H, Hesselfeldt P (2007). Rectal adenocarcinoma and transanal endoscopic microsurgery. *Int J Colorectal Dis* **22**, 1347–52.
- Colon Cancer Laparoscopic or Open Resection Study Group (2009). Survival after laparoscopic surgery versus open surgery for colon cancer: long-term outcome of a randomised clinical trial. *Lancet Oncol* **10**, 44–52.
- den Dulk M, van de Velde CJ (2008). Time to focus on the quality of colon cancer surgery. *Lancet Oncol* **9**, 815–16.
- Hendry PO, Hausel J, Nyggen J, et al. (2009). Determinant of outcome after colorectal resection within an enhanced recovery programme. *Br J Surg* **96**, 197–205.
- Hogan AM, Kennelly R, Winter DC (2009). Volume–outcome analysis in rectal cancer: a plea for enquiry, evidence and evaluation. *Eur J Surg Oncol* **35**, 111–12.
- Liang Y, Li G, Chen P, Yu J (2008). Laparoscopic versus open colorectal resection for cancer: a meta-analysis of results of randomized controlled trials on recurrence. *Eur J Surg Oncol* **34**, 1217–24.
- Tythenleigh MG, Warren BF, Mortensen NJ (2008). Management of early rectal cancer. *Br J Surg* **95**, 409–23.

## Adjuvant chemotherapy of colorectal cancer

### Rationale

Half of the patients undergoing apparently curative resection of bowel cancer are destined to relapse and eventually die with either locally recurrent or distant metastatic disease. This is due to the presence of residual micrometastases, invisible at the time of surgery. The aim of adjuvant chemotherapy is to eradicate these micrometastases and thereby prevent future relapse.

### Indications

Adjuvant chemotherapy is an exercise in risk reduction. Questions to be considered, after a potentially curative operation, are the following:

- what is the probability of micrometastases?
- will adjuvant therapy prevent/delay relapse?
- what are the side effects?

MDT discussion is essential.

The risk that the patient has micrometastases is estimated after surgery by examining the pathological features of the 1° cancer.

- Dukes' C cancers, which have spread to the nearby lymph nodes, carry a much higher risk (around 50%). There is good evidence that this risk is reduced by adjuvant chemotherapy, which is now offered routinely in most centres, unless there is a strong contraindication.
- Dukes' B cancers, which have breached the muscle layers, but not spread to lymph nodes, carry an intermediate risk of around 30%. There is evidence to support the use of adjuvant chemotherapy in these patients, but this is an area of ongoing controversy. Research efforts are being made to provide tests which can better delineate the risk–benefit equation in this group.
- Rectal cancer, which accounts for nearly 40% of bowel cancers, presents some special considerations. A relative lack of a barrier to lateral spread and increased technical difficulty of surgery in the pelvis combine to make local recurrence a particular problem. Radiotherapy, targeted to the pelvis either before or after surgery, reduces local recurrence rates. Adjuvant therapy for rectal cancer may therefore include both radiotherapy and chemotherapy aimed, respectively, at local and systemic micrometastases.

### Chemotherapy used in adjuvant setting

- Until recently, the standard was fluorouracil, given in combination with FA, by bolus IV injection for a total period of 6mo. A variety of alternative regimens are used in different countries and institutions.
- Oxaliplatin is a platinum analogue which, when added to fluorouracil and FA, has been shown to result in superior survival at the cost of some (mainly short-lived) extra toxicity. This regimen (FOLFOX) has become a standard in many countries in those patients who are deemed suitable for such therapy. More recently, the addition of oxaliplatin has been questioned, especially in the more elderly patients, and the standard of care is thus highly variable.

- Capecitabine (which is an oral pro-drug of fluorouracil) has been shown to be active in the adjuvant setting and has replaced IV chemotherapy in some institutions. The dosing and potential combinations with oxaliplatin (XELOX) have also been tested and shown to be equivalent in efficacy to FOLFOX, but with a slightly different toxicity profile.
- Studies investigating the addition of agents that target EGFR or VEGF receptor have failed to show real benefits, and these agents are not indicated in the adjuvant setting.
- Fluorouracil (and capecitabine) is also a radiosensitizer. For patients with rectal cancer, pre- or post-operative pelvic radiotherapy is sometimes given concurrently with chemotherapy, to harness this effect. This may be followed by a more prolonged course of standard adjuvant chemotherapy, aimed at distant micrometastases.

### Side effects

The clinical activity of fluorouracil and its side effects are both critically dependent upon the dose and schedules used and vary considerably from patient to patient. The side effect profile should, for most patients, be quite easily tolerable and consistent with continuing normal activity, including work. Treatment is feasible, even in the elderly. Capecitabine is associated with a higher incidence of hand-foot syndrome, but this can usually be managed by judicious dose reductions.

#### *Common side effects*

- Nausea and vomiting.
- Oral mucositis.
- Diarrhoea.
- Red, painful palms and soles (hand-foot syndrome).
- Peripheral neuropathy (when oxaliplatin is included).

## Chemotherapy for advanced colorectal cancer

- Defined as disease that is outwith the possibility of curative resection.
- Mostly, this is defined by the presence of metastatic disease which is unresectable.
- Poor prognosis and, in most cases, the aim of therapy is palliation, although prolongation of survival has been achieved by application of modern chemotherapy agents.
- The median survival time for such patients without further therapy is of the order of 6mo.
- In most cases, therapy is based on chemotherapy, but this does not preclude the use of combined modalities such as localized radiotherapy or ablative techniques for liver metastases.
- A small proportion of patients have so-called pauci-metastatic disease, in other words, disease that is potentially resectable or could be made so by volume reduction using chemotherapy (downstaging). These highly selected patients should be identified and treated within an MDT setting, with a view to surgical resection and potential cure of the disease.
- There are multiple choices of chemotherapy combined with targeted therapies, but no consensus has been reached as to the optimal pathway of care. This has led to a profusion of clinical guidelines, with marked variation in practice across the globe.

### First-line chemotherapy

(See Table 15.1.)

Fluorouracil is still the most widely used single agent. There is no consensus as to the optimal dosing and scheduling of this drug. However, most authorities now accept that infusional regimens result in better response with less toxicity. Biochemical modulation by the use of concurrent FA (leucovorin) also seems to improve response rates. Response rates of between 10% and 50% have been quoted for regimens combining fluorouracil/FA.

This variability is probably a reflection of patient selection as much as the efficiency of the chemotherapy employed. Various regimens have been able to demonstrate survival improvements of about 6mo over patients treated with best supportive care alone. Different regimens have differences in the toxicity profile, with boluses tending to cause more marrow toxicity, and protracted infusions causing more diarrhoea and hand-foot syndrome (see Table 15.2).

Oxaliplatin is a platinum analogue that is active in colorectal cancer. Synergy with fluoropyrimidines has been demonstrated in clinical trials. Combination studies with fluorouracil-based regimens (so-called FOLFOX regimens, known as XELOX when capecitabine is used in the place of fluorouracil/FA) versus the same regimen without oxaliplatin have confirmed a higher response, with some studies also showing survival benefits. A striking feature of these studies is the numbers of patients who are 'downstaged' by the combination therapy and then go on to have salvage surgery, with some achieving long-term remission. Even though there are no prospective studies, this combination is often used in patients with pauci-metastatic disease.

Table 15.1 Commonly used regimens in first-line treatment of advanced colorectal cancer

Regimen	Dose	Route	Dose interval	Repeat
5-FU-leucovorin	Highly variable	IV bolus and infusion	Variable	Variable
Capecitabine		PO	14 days	3wk
FOLFIRI/XELIRI—substitute capecitabine for FU/FA	Irinotecan 130–180mg/m <sup>2</sup>	FA 400mg/m <sup>2</sup> bolus	fluorouracil 2400–3000mg/m <sup>2</sup> IVI over 46h	2wk
FOLFOX/XELOX—substitute capecitabine for FU/FA	Oxaliplatin 85mg/m <sup>2</sup>	FA 400mg/m <sup>2</sup> bolus	fluorouracil 600mg/m <sup>2</sup> as 22h IVI	3wk
FOLFIRI/XELIRI				14 days XELOX

IVI, intravenous infusion.

**Table 15.2** Second-line chemotherapy

	FU/leuc	FOLFOX	FOLFIRI	Capecitabine
Nausea/vomiting	+	+	+	+
Diarrhoea	+++	++	+++	++
Mucositis	+++	+	+	+
Myelosuppression	++	+	+++	+
Alopecia	–	–	+	–
Hand-foot syndrome	+	–	++	+++

In the last few years, the introduction of a number of new agents into this therapy area has dramatically changed how this disease is treated.

Irinotecan is a topoisomerase inhibitor. The drug has shown single-agent activity in first- and second-line use. In combination with FU/FA (commonly known as FOLFIRI, or XELIRI when capecitabine replaces the FU/FA components), first-line trials confirmed improved response and overall survival, such that this combination became an accepted standard of care. However, the combination does have the potential to cause severe toxicity such as diarrhoea and neutropenia. As a result, there is no current consensus as to the optimal regimen for therapy of advanced colorectal cancer.

Capecitabine is an orally administered pro-drug of fluorouracil. In advanced colorectal cancer, it has shown improved response over a fluorouracil regimen and equivalent survival. The convenience to the patient of replacing infusional regimens of fluorouracil with oral medication is an important factor. Studies combining capecitabine with irinotecan or oxaliplatin have shown favourable results, and the drug is now considered as part of the standard of care in most countries. Although other oral fluoropyrimidines have been developed, none are as widely used as capecitabine.

Bevacizumab is an agent which targets the vascular supply of the cancer. It has shown very modest single-agent activity, but, when combined with FOLFIRI or FOLFOX-like regimens, there is a clear additional benefit. This agent has been licensed in this indication in many countries, but its use is still somewhat controversial. It does produce some specific side effects such as hypertension and clotting issues. There is no evidence that the benefits of bevacizumab are limited to subsets of patients, and, despite extensive research, no biomarkers which define activity have been discovered.

Cetuximab is a mAb that targets the EGFR. The drug has shown activity both as a single agent and in combination with cytotoxic drugs, particularly irinotecan. Although now considered part of the standard of care, there remains controversy over its place. In particular, the relative benefits of bevacizumab versus cetuximab are unclear, and it is increasingly becoming the norm that patients will be exposed to all agents at some time in the course of their treatment time. Cetuximab has two unique attributes which help define its place in therapy.

First, it produces an acneiform rash which occurs in at least 30% of people. Interestingly, the severity of the rash correlates with the beneficial effect.



Second, the drug benefits only those patients who have *K-ras* wild-type tumours. So molecular selection is used by analysis of the tumour tissue, so that those who have *K-ras* mutations in their cancer are not exposed to an ineffectual therapy.

Combinations of the agents listed above have been tested in a large number of clinical trials. Consensus exists that combination therapy offers higher response rates at the cost of some increase in subjective toxicity. Since, in most cases, the aim of therapy is palliation, a number of important issues arise:

- which combination is best?
- which sequence of agents?
- continuous or intermittent exposure to treatment?
- how to best combine the targeted drugs?
- which regimen is best to downstage patients who may be candidates for resection of metastases?

These and other questions will form the basis of clinical research in this area for some time to come.

### Second-line chemotherapy

Irinotecan was the first agent to show real activity in patients who had relapsed, following fluorouracil, or progressed whilst on this therapy. Various combinations of irinotecan with fluorouracil (known as FOLFIRI) are widely used. No consensus exists as to the optimal combination doses or schedules.

Oxaliplatin has not been tested as extensively as a single agent in second-line therapy. However, the addition of oxaliplatin into a regimen of fluorouracil, where the patient has 'failed', has shown activity. Likewise, there are a number of regimens which collectively are known as FOLFOX. Once more, there is no real consensus as to the best doses and schedules.

The optimal sequencing of these regimens is also not clear. The common practice is to start therapy with a FOLFOX-like regimen and replace this with FOLFIRI when the tumour is no longer responsive, or the vice versa sequence of regimens.

Regorafenib is a novel agent which acts by inhibiting multiple TKs in the oncogenic pathways of colorectal cancer. It has recently shown survival benefit in so-called 'last line' patients, i.e. those that have exhausted the agents described earlier. It is undergoing regulatory review in various countries at present, and its place in standard of care is not yet defined.

## **Radiotherapy in colorectal cancer**

- In colonic cancer, radiotherapy is limited to the palliative situation in most circumstances.
- The rectum is immobile and fixed within the pelvis, and therefore a suitable target for radiotherapy.
- Radiotherapy has been used in both the preoperative and post-operative setting in this disease.
- In the preoperative situation, there is a group of patients (10–15%) who present with large fixed or tethered tumours that are non-resectable. Only half of this group will have distant metastases at presentation. The conversion rate to resectability is 35–75%, with a dose of 50–60Gy given over a 5wk period.

# Anal cancer

Introduction 312

Anal squamous cell carcinoma 314

Rarer tumours 316

Practical points 316

## Introduction

- 3–5% of all large bowel malignancies.
- Most anal tumours arise from the epidermal elements of the anal canal lining (squamous cell—85% of anal tumours), although some arise from the glandular mucosa of the uppermost part of the anal canal or from the anal ducts and glands (adenocarcinomas—10% of anal tumours).
- Malignant melanoma of the anus is very rare (<5% of anal tumours) and carries a poor prognosis.



## Anal squamous cell carcinoma

### Epidemiology

- Rare cancer, around 250 UK cases per annum.
- ♂:♀ ratio 1:3.
- Usually >50y.
- Areas with a high incidence of anal cancer also tend to have a high incidence of cervical, vulval, and penile tumours.

### Aetiology

- HPV infection.
- Receptive anal intercourse.
- Sexually transmitted disease, >10 sexual partners.
- Previous cervical, vulval, or vaginal cancer.
- Immunosuppression after solid organ transplant.
- Human immunodeficiency virus (HIV) infection.
- Cigarette smoking.

### Pathology and natural history

- Included within the category of epidermoid tumours are:
  - SCCs
  - basaloid (or cloacogenic) carcinomas
  - mucoepidermoid cancers.
- The anal sphincter and recto-vaginal septum, the perineal body, and the vagina are common sites of direct invasion.
- Lymph node spread occurs initially to the peri-rectal group of nodes and thereafter to the inguinal, haemorrhoidal, and lateral pelvic lymph nodes.
- 10% of patients will present with inguinal lymph node involvement, but this rises to ~30% when the 1° tumour is >5cm in diameter.
- Blood-borne spread tends to occur late and is usually associated with advanced local disease. The most common sites of metastases are the liver, lung, and bones.

### Clinical presentation

- Symptoms of epidermoid anal cancer:
  - pain
  - bleeding
  - itch
  - discharge
  - mass.
- Later symptoms:
  - faecal incontinence
  - ano-vaginal fistula.

Approximately one-third of patients with anal carcinoma have enlarged inguinal lymph nodes on presentation, but less than half this number has metastatic nodes. Often the nodes are secondarily infected or reactive.

## Investigation and staging

- Careful examination under anaesthetic, with biopsy of the lesion, documentation of the length, site, and extent of 1° tumours.
- FNA cytology—enlarged inguinal lymph nodes.
- CT or MRI scan—abdomen and pelvis.
- Staging commonly uses the TNM system (see  <https://cancerstaging.org> to download the TNM staging).

## Management

Over the last 20y, treatment of this cancer has moved from surgery (abdomino-perineal resection) to organ-conserving therapy, and chemo-irradiation is now a standard treatment for the majority (T2–4, and all node-positive patients).

Randomized trials, such as ACT 1 (Anal Cancer Trial), have demonstrated a 20% improvement in local control with chemo-irradiation, compared with radiotherapy alone.

- Most recurrence is loco-regional.
- Small lesions at the anal margin may still best be treated by local excision alone, obviating the need for protracted courses of non-surgical therapy. The most recent development is SLNB of the inguinal nodes, and it has been well demonstrated in a recent German study to be efficient and practical.
- An important role for the surgeon is in treatment after failure of 1° non-surgical therapy, either early or late. The appearance of the 1° site can be misleading after radiotherapy. A proportion of patients develop complications, such as radio-necrosis, fistula, or incontinence, following radical radiation or combined therapy.

## Treatment outcomes

- 60–70% 5y survival.
- 70–80% anal preservation.
- The prognosis depends on the tumour size, lymph node status (node-positive—50% 5y survival).

## Further reading

Gretschel S, Warnick P, Bembenek A, et al. (2008). Lymphatic mapping and sentinel lymph node biopsy in epidermoid carcinoma of the anal canal. *Eur J Surg Oncol* 34, 890–4.

## Rarer tumours

### Adenocarcinoma

Adenocarcinoma in the anal canal is usually a very low rectal cancer that has spread downwards to involve the canal, but true adenocarcinoma of the anal canal does occur, probably arising from the anal glands that arise around the dentate line and pass radially outwards into the sphincter muscles. This is a very rare tumour; although it is radiosensitive, it is still usually treated by radical surgery.

### Malignant melanoma

This tumour is excessively rare, accounting for just 1% of anal canal malignant tumours. The lesion may mimic a thrombosed external pile due to its colour, although amelanotic tumours also occur. It has an even worse prognosis than at other sites. As the chances of cure are minimal, radical surgery as 1° treatment has been all but abandoned.

## Practical points

- Rectal bleeding and anal pain are common—a high degree of suspicion is required to diagnose anal cancer correctly.
- Multifocal anal and genital disease may coexist—be sure to examine the anal and genital areas.
- Examination under anaesthetic is essential for adequate staging and also permits a generous biopsy.
- Biopsy or needle aspiration of enlarged inguinal lymph nodes is essential prior to treatment.
- Local excision may be appropriate for small anal margin cancers.
- Chemo-irradiation is the treatment of choice for most anal squamous carcinomas.



# Upper gastrointestinal cancer

- Oesophageal 318
- Gastric 324
- Small Intestinal 330
- Hepatic 336
- Treatment of hepatocellular carcinoma 344
- Liver metastases 350
- Treatment of colorectal liver metastases 352
- Pancreatic: ductal adenocarcinoma 358
- Pancreatic: pancreatic neuroendocrine tumours 364
- Ampullary carcinoma 368
- Gall bladder 372
- Biliary tract 376

## Oesophageal

### Epidemiology

- Ninth commonest cancer in Western countries, including the UK where it accounts for 3% of new cancer cases.
- ~2.5 times as common in ♂, compared with ♀.
- The incidence increases with age, with an 8-fold increase between the age ranges of 45–54y and 65–74y.
- Highest rates are seen in South Africa and China.
- In the UK, in 2010, 8477 people were diagnosed with oesophageal cancer, and 7610 died of the disease.
- Accounts for ~5% of cancer-related deaths in Western countries.

### Aetiology

- Aetiological factors vary with geographical region and with histological subtype.
- Risk factors for SCCs include smoking, excess alcohol consumption, dietary factors (nitrate-containing preserved foods, low levels of antioxidants), betel nut chewing; achalasia, lye strictures, Paterson–Brown–Kelly syndrome (Plummer–Vinson syndrome), tylosis palmaris, HPV infection, mediastinal radiotherapy, and consumption of very hot drinks.
- Risk factors for adenocarcinomas include gastro-oesophageal reflux disease, Barrett's oesophagus (especially high-grade dysplasia), achalasia, and obesity. Heavy smoking, alcohol, and a poor diet are weakly associated, as are scleroderma, achalasia, and lye strictures.
- Currently, no definite genetic predisposition to oesophageal carcinoma is recognized.

### Pathology

- The two main types of tumour are SCC and adenocarcinoma, with the former affecting the proximal two-thirds, and the latter the middle and distal oesophagus.
- Historically, SCCs were the predominant histological subtype, but there has been a decline in the number of these patients. Squamous carcinoma is the commoner tumour type in the middle and Far East and in Africa.
- There has been a striking rise in incidence of adenocarcinoma of the lower oesophagus and GOJ, and this is now the commonest subtype in the UK. It is also more prevalent than squamous carcinoma in Western Europe and the US.
- Adenocarcinomas arising around the oesophago-gastric junction are regarded as a separate entity, and their behaviour is more aggressive than more proximal oesophageal adenocarcinomas. They are classified, as shown in Table 17.1.
- Rarer histological subtypes include leiomyosarcoma and GIST.

**Table 17.1** Siewart classification of junctional tumours

Type I	Distal oesophageal	Centre of tumour lies 1–5cm above the anatomic cardia
Type II	Cardia of stomach	Centre of stomach from 1cm above to 2cm below the anatomic cardia
Type III	Proximal stomach	Centre of tumour lies 2–5cm below the anatomic cardia

Adapted from Siewert JR, Feith M, Werner M, Stein HJ (2000). Adenocarcinoma of the esophagogastric junction: results of surgical therapy based on anatomical/topographic classification in 1,002 consecutive patients. *Ann Surg*; 232: 353–361, with permission from Lippincott Williams & Wilkins.

## Presentation

- The typical history is of progressive dysphagia, initially to solids and later liquids. Patients may report regurgitation of food. Dysphagia is one of the upper GI alarm symptoms, and British Society of Gastroenterology (BSG) guidelines advise that patients require urgent referral (within 2wk) for investigation; 25% of patients with true dysphagia will have an underlying oesophageal carcinoma.
- Often associated with weight loss, anorexia, and emaciation that are frequently of rapid onset.
- Other symptoms include odynophagia (painful swallowing), hoarseness (recurrent laryngeal nerve invasion), chest pain due to bolus impaction, respiratory symptoms (aspiration or tracheo-oesophageal fistula (TOF)), and halitosis due to residual food matter.
- Examination is usually non-contributory for early disease, but cervical lymph nodes, weight loss, anaemia, and hepatomegaly may be seen with advanced disease.

## Diagnosis

- Endoscopy and biopsy are the investigation of choice, as they allow direct visualization of the tumour and provide an opportunity for obtaining tissue for histological analysis. They allow documentation of the site and size of the lesion and allow biopsies to be performed (minimum of six).
- In areas of high incidence, population screening with endoscopy is undertaken.
- Barium/Gastrografin® swallow examinations are sometimes used and demonstrate irregular strictures in the case of carcinoma. However, endoscopic biopsy is still required prior to consideration of resection.
- CT scanning of the chest and abdomen is the first line of staging to detect distant metastatic disease and provides a good idea of local spread.
- For patients with no evidence of metastatic disease, EUS is used to better define the local infiltration of adjacent structures, including the aorta and trachea, and provide more accurate assessment of the tumour and adjacent lymph nodes. Targeted biopsies of suspicious lymph nodes can also be performed, if their presence would influence the treatment course.

- A PET scan with  $^{18}\text{F}$ -fluorodeoxyglucose, combined with CT (FDG-PET-CT), can improve detection of distant metastases but is less useful in staging 1° and loco-regional nodal disease. It is of particular benefit for oesophageal cancers, given the morbidity and mortality of oesophagectomy.
- Laparoscopy is important for patients with lower oesophageal or GOJ adenocarcinomas, to detect peritoneal and liver metastases.
- For tumours above the level of the carina, bronchoscopy may be used to assess bronchial invasion; however, EUS is usually sufficient.

### Staging

The staging of oesophageal carcinoma follows the TNM system (see <https://cancerstaging.org> to download the TNM staging).

### Treatment

- Treatment recommendations should be undertaken in the setting of an MDT approach, including surgeons, gastroenterologists, radiologists, oncologists, pathologists, dieticians, and specialist nurses. Patient co-morbidities, nutritional status, and patient preference should be considered, in addition to staging information.
- Patients with high-grade dysplasia, confirmed by two histopathologists (at least one of whom is an oesophago-gastric specialist), are also regarded as candidates for treatment and should be discussed at an oesophago-gastric MDT.

### Potentially curable disease

#### *Surgical resection*

- Endoscopic mucosal resection may be considered for early oesophageal neoplasms limited to the mucosa (T1a).
- Patients may be suitable for neoadjuvant chemotherapy or chemo-radiotherapy (see [Adjuvant/neoadjuvant therapy, p. 321](#)), and this should be determined in the MDT. The timing of surgery, following such treatment, is important, as is the need to re-stage the tumour.
- Resectable tumours are T1b–T3 ± N1. T4 tumours invading the diaphragm, pleura, or pericardium may also be considered candidates.
- For patients with resectable tumours, careful preoperative evaluation is required. The exact protocol is variable from unit to unit but should include cardiac and respiratory assessment, as patients undergoing resection will be maintained on single-lung ventilation during the thoracic phase of the surgery.
- Nutritional assessment is important, as many patients with dysphagia are malnourished (body mass index, BMI <18.5 or >20% weight loss). Following dietary assessment, preoperative nutrition may be desirable.
- Perioperative morbidity and mortality are lower in specialized centres, with mortality rates of <5% in contemporary series, and so all oesophagectomies are performed in designated cancer centres in the UK.
- Preoperative preparation includes thromboembolic prophylaxis, antibiotic prophylaxis, and provision of a high dependency unit (HDU)/intensive care unit (ICU) bed. The majority of patients are offered epidural analgesia.

- Surgical approaches include the Ivor Lewis 2 stage transthoracic oesophagectomy, in which separate incisions are made in the chest and abdomen, and transhiatal oesophagectomy, in which all the procedure is performed via the abdomen. The oncological outcomes of the two procedures have been shown to be comparable in an RCT. The transhiatal approach is limited to tumours of the lower oesophagus, as access is limited to more proximal tumours. Upper one-third tumours may require a three-stage oesophagectomy, with a cervical incision and anastomosis.
- Minimally invasive resection can be performed and has been shown to be safe with comparable oncological outcomes. However, it is currently limited to specialist centres and is being subjected to close scrutiny, as some major complications, including gastric tube necrosis, appear more common after a laparoscopic approach.
- The proximal resection margin should be at least 10cm clear of the macroscopic tumour and the distal 5cm or more.
- Following resection, continuity is usually restored, using a gastric tube as a conduit. Other options for extensive resections include the colon and jejunum.
- For carcinomas limited to the mucosa, the 5y survival is >80%, and >50% for disease extending into the submucosa. The overall 5y survival for oesophageal carcinoma post-resection is around 25%.
- The morbidity of an oesophagectomy is significant at around 40%. An anastomotic leak is the most serious operation-specific complication (5%), with others including respiratory (pneumonia, atelectasis), cardiac (MI, heart failure, AF), recurrent laryngeal nerve injury, DVT and PE, and chylothorax.
- Good analgesia, early mobilization, and judicious use of IV fluids help to reduce complication rates.

#### Adjuvant/neoadjuvant therapy

- Post-operative adjuvant therapy is difficult to deliver after major oesophageal surgery.
- Neither chemotherapy, radiotherapy, nor chemo-radiotherapy has a survival advantage when administered post-operatively.
- Neoadjuvant (i.e. preoperative) chemotherapy is easier to deliver and can treat micrometastatic disease.
- The UK MRC OE02 study (MRC 2002) ( $n = 802$  patients) demonstrated a significantly greater OS for patients who received two courses of preoperative chemotherapy with cisplatin ( $80\text{mg}/\text{m}^2$  on day 1) and fluorouracil ( $1\text{mg}/\text{m}^2$  by continuous infusion (days 1–4)) at 3wk intervals, compared with surgery alone.
- The median survival was significantly improved with preoperative chemotherapy (16.8mo), compared with surgery alone (13.3mo).
- There was no increase in perioperative morbidity and mortality in patients treated with preoperative chemotherapy.
- Further evidence to support the use of preoperative chemotherapy comes from the MRC MAGIC trial (see  Adjuvant/neoadjuvant therapy, p. 327; Cunningham (2006)). Although initially a study in gastric cancer patients, the study was subsequently extended to include patients with GOJ tumours (15% of the total) and lower oesophageal adenocarcinomas (11%).

- A number of other studies have not demonstrated a benefit from neoadjuvant chemotherapy in patients with oesophageal cancer. However, based on the MRC OE2 and MRC MAGIC studies, preoperative chemotherapy is recognized as standard practice in the UK.
- Some non-randomized studies of chemo-radiation suggest that this approach may give long-term survival results equivalent to surgical treatments and may be an alternative approach for patients with SCCs or for patients who are unfit for surgery.
- However, there have been no trials comparing surgery, with or without preoperative treatment, with chemo-radiation alone in operable disease.

### Locally advanced disease

- Surgical resection of the oesophagus for palliation should be avoided. Likewise, there is no real role for tumour bypass surgery.
- Treatment of dysphagia in the palliative setting is usually achieved by dilatation of the malignant stricture and stent insertion. This leads to a rapid resolution of symptoms and provides the patient the opportunity to eat again, although semi-solid diets are advised. The majority of stents now used consist of a metallic mesh. Complications of stenting include migration, perforation, occlusion, and tumour overgrowth.
- Other palliative therapies include laser ablation and alcohol injection. Complications of the former include perforation (0–5%) and TOF (0–5%). Complications are fewer with alcohol injection, but TF with mediastinitis is seen in up to 2% of cases. Photodynamic therapy is another option. However, availability is limited.
- Combined modality approaches incorporating cisplatin-based chemotherapy, in addition to radiation, is superior to radiotherapy alone for patients with locally advanced oesophageal cancer.
- Combined modality treatment results in a significantly better median survival (14mo), compared with radiotherapy alone (9.3mo), and a significantly better 5y survival (26% versus 0%). However, such combined modality therapy does carry significant morbidity and is not suitable for all patients. This is another example when the MDT approach is important.

### Metastatic disease

- Many patients have metastatic disease at presentation or develop metastases after treatment for localized disease.
- The combination of cisplatin and a fluoropyrimidine (either fluorouracil or capecitabine) is one of the most commonly used regimens for advanced disease.
- Epirubicin, in addition to cisplatin and a fluoropyrimidine, has been the standard in the UK for adenocarcinomas of the oesophagus or GOJ.
- The oral fluorouracil prodrug capecitabine and oxaliplatin are the standard agents used for patients with adenocarcinomas, in combination with epirubicin, in the UK, based on the results of a large randomized clinical trial (see ➔ Metastatic disease, p. 327).
- Trastuzumab is used in combination with cisplatin and a fluoropyrimidine in patients with HER2-positive adenocarcinomas of the GOJ (see ➔ Metastatic disease, p. 328).

## Further reading

- Allum WH, Blazeby JM, Griffin SM, Cunningham D, Jankowski JA, Wong R; Association of Upper Gastrointestinal Surgeons of Great Britain and Ireland, the British Society of Gastroenterology and the British Association of Surgical Oncology (2011). Guidelines for the management of oesophageal and gastric cancer. *Gut* **60**, 1449–72.
- Cancer Research UK (2013). Oesophageal cancer statistics. Available at: <http://www.cancer-researchuk.org/cancer-info/cancerstats/types/oesophagus>
- Cunningham D, Allum WH, Stenning SP, et al. (2006). Perioperative chemotherapy versus surgery alone for resectable gastroesophageal cancer. *N Engl J Med* **355**, 11–20.
- Hardwick RH; the Association of Upper Gastrointestinal Surgeons (AUGIS) and the Association of Laparoscopic Surgeons of Great Britain & Ireland (ALS) (2009). A consensus view and recommendations on the development and practice of minimally invasive oesophagectomy. Available at: [http://www.alsgbi.org/pdf/Augis\\_Brochure.pdf](http://www.alsgbi.org/pdf/Augis_Brochure.pdf).
- Herskovic A, Martz K, al-Sarraf M, et al. (1992). Combined chemotherapy and radiotherapy compared with radiotherapy alone in patients with cancer of the esophagus. *N Engl J Med* **326**, 1593–8.
- Mapstone NP (2011). *Standards and datasets for reporting cancers. Dataset for the histopathological reporting of oesophageal carcinoma*, 2nd edn. London: Royal College of Pathologists, pp. 1–15.
- Medical Research Council Oesophageal Cancer Working Group (2002). Surgical resection with or without preoperative chemotherapy in oesophageal cancer: a randomised controlled trial. *Lancet* **359**, 1727–33.
- National Oesophago-Gastric Cancer Audit (2010). Third annual report. London: The NHS Information Centre, pp. 1–69.
- Omloo JM, Lagarde SM, Hulscher JB, et al. (2007). Extended transthoracic resection compared with limited transhiatal resection for adenocarcinoma of the mid/distal esophagus: five-year survival of a randomized clinical trial. *Ann Surg* **246**, 992–1000.
- Siewert JR, Feith M, Werner M, Stein HJ (2000). Adenocarcinoma of the esophagogastric junction: results of surgical therapy based on anatomical/topographic classification in 1,002 consecutive patients. *Ann Surg* **232**, 353–61.

## Gastric

### Epidemiology

- Now the fourth commonest cancer worldwide, having ranked first in the mid 1970s.
- There is a ♂ predominance of ~2.2:1.
- The incidence increases with age and peaks in the eighth decade. Only 8% aged <55y.
- Highest rates are seen in Eastern Asia, Eastern Europe, and South America.
- The incidence varies considerably globally, with an 11-fold variation for ♀ and a 9-fold difference between the highest and lowest incidence for ♂.
- In the UK, it is the ninth commonest malignancy in ♂ and 14th in ♀.
- There has been a 32% reduction in incidence of the past decade in ♂ and a 28% fall in ♀.
- Despite an overall fall in the incidence of gastric cancer, the incidence of carcinomas of the cardia, as with oesophageal junctional tumours, has risen significantly.
- Remains the second commonest cause of cancer death worldwide, and seventh in the UK, accounting for 3% of cancer deaths.

### Aetiology

- The wide global variation in stomach cancer suggests environmental factors exert a strong effect.
- In the UK, 78% of ♂ and 69% of ♀ stomach cancers were linked to lifestyle or environmental factors.
- *Helicobacter (H.) pylori* infection is associated with a 3-8 fold increased incidence of gastric cancer. *H. pylori* eradication has been shown to reduce the risk of gastric carcinoma.
- Other significant environmental factors increasing the risk of stomach cancer include smoking, diet (eating of pickled or salt-preserved foods, low consumption of fruit and vegetables), heavy alcohol consumption, occupational (rubber industry), and a low socio-economic status.
- Other risk factors include reduced gastric acid production (pernicious anaemia, previous gastric surgery), infection with EBV, blood group A, and radiation exposure.
- Tumours of the cardia are associated with gastro-oesophageal reflux disease (GORD) and obesity.
- In a small proportion of patients (1-3%), there is an inherited germline inactivating mutation of the E-cadherin gene *CDH-1*. Also there is an increased risk for individuals with *BRCA2*, but not *BRCA1*, mutations. Also associated with Li-Fraumeni, FAP, HNPCC, and Peutz-Jeghers syndromes.

### Pathology

- The majority of gastric tumours (>90%) are adenocarcinomas, which are further divided into intestinal and diffuse types (Lauren classification).
- The intestinal type usually arises in association with a precancerous condition such as gastric atrophy or intestinal metaplasia. It is more common in men, and its incidence increases with age. This is the



dominant form in areas where gastric cancer is high. Lesions are usually well differentiated, occur in the distal stomach, and exhibit blood-borne metastases.

- The diffuse type of gastric carcinoma is usually poorly differentiated and is usually composed of signet rings. It is more common in younger patients and in ♀. The tumour spreads submucosally and disseminates via the lymphatic system. It is associated with blood group A and occurs in families, suggesting a genetic component to the aetiology.
- Other histopathologies include SCC, carcinoid, GIST, and lymphoma.

### Presentation

- Symptoms of gastric cancer are non-specific, especially in early disease, with dyspepsia being the most common symptom reported.
- In more advanced disease, weight loss, anorexia, early satiety, or vomiting.
- Junctional tumours may lead to dysphagia and odynophagia.
- There are no signs in early tumours, but, in more advanced, palpable mass, supraclavicular lymphadenopathy (Virchow's node), periumbilical mass (Sister Joseph's nodule), ascites, and jaundice. A succussion splash may be detected in cases where gastric outlet obstruction is present.

### Investigation

- The BSG have specific guidelines for the referral of patients with suspected gastric cancer for endoscopy and biopsy.
- All patients aged over 55y with recent-onset dyspepsia.
- Any patient with dyspepsia in combination with an alarm symptom (weight loss, anaemia, anorexia), regardless of age.
- Dyspepsia in combination with—family history in >1 relative; Barrett's oesophagus; pernicious anaemia; gastric surgery >20y ago; known dysplasia, atrophic gastritis, or intestinal metaplasia; jaundice; upper abdominal mass.
- Endoscopy allows documentation of the site and size of the lesion. Multiple biopsies (>6) should be performed from the ulcer edge, not the crater.
- A CT scan of the chest, abdomen, and pelvis is required to assess distant metastases.
- EUS is used, if required, to evaluate the depth of invasion and lymph nodes.
- PET-CT is used selectively to evaluate for distant metastases if the findings of CT are uncertain.
- Laparoscopy is used pre-resection in most patients with gastric cancer to examine for peritoneal disease, and it alters management in up to 30% of patients, based on CT/EUS findings. Peritoneal washings are also obtained and sent for cytological analysis. In patients with symptomatic cancers, laparoscopy may be omitted if the tumour is to be resected, regardless of the findings.

### Staging

The staging of gastric carcinoma follows the TNM system (see  <https://cancerstaging.org> to download the TNM staging).

**Treatment***Potentially curable disease*

- Surgery is the 1° treatment modality for gastric carcinoma.
- Early cancers (T1a mucosal and T1b submucosal) may be treated by endoscopic mucosal resection.
- ~50% of patients have resectable disease at presentation, but only half of these will undergo curative (R0) resections.
- The choice of operation is dependent on the tumour location, with a total gastrectomy the procedure of choice for proximal tumours, and a subtotal gastrectomy for distal tumours.
- The resection margins should be at least 5cm from the nearest tumour focus. The proximal resection margin should be at least 10cm clear of the macroscopic tumour, and the distal 5cm or more.
- The extent of lymphadenectomy is controversial. Non-randomized series from Japan have shown that extended lymphadenectomy (D2 resection) improves DFS in selected patients, compared to historical controls. Both the MRC and Dutch randomized controlled studies failed to demonstrate any benefit for D2 dissection, compared with limited dissection (D1). Differences are believed to be related to the different types of cancer seen.
- Minimally invasive gastric resections can be performed safely, with meta-analyses suggesting an equivalent oncological outcome, but with a lower morbidity. The majority of studies so far have been performed in the Far East, and confirmation in Western series is awaited.
- Following a total gastrectomy, continuity is restored by means of a Roux-en-Y reconstruction. A number of options are available for reconstruction following a subtotal gastrectomy, including Billroth II or Roux-en-Y.
- For carcinomas limited to the mucosa, the 5y survival is >95%, and >75% for disease extending into the submucosa. The OS for gastric carcinoma post-resection is around 42%.
- A number of complications are observed following gastrectomy. Important operation-specific early complications include bleeding (often short gastric vessel or splenic tear) and an anastomotic leak (usually after day 5). Important late complications include dumping syndrome (early or late—due to large volumes of high-osmolarity food entering the small bowel), anaemia (iron deficiency, folate deficiency, B12 deficiency—lack of intrinsic factor), impaired fat absorption, osteoporosis or osteomalacia, afferent loop syndrome after Billroth II gastrectomy or gastrojejunostomy (due to non-draining afferent loop), and reflux gastritis (following Billroth II).
- Enhanced recovery programmes help to reduce complication rates.

*Adjuvant/neoadjuvant therapy*

- Several adjuvant chemotherapy studies have used a number of regimens, and only one small study has shown an improved survival. A meta-analysis of over 2000 patients treated in adjuvant chemotherapy trials concluded that there was no survival benefit.
- Post-operative radiation, combined with concurrent fluorouracil-based chemotherapy, can improve the 3y OS rate (50%), compared with

surgery alone (41%). However, 54% of patients in this study had less than a D1 dissection, and <10% had a D2 dissection.

- The standard of care in the UK is perioperative ECF/ECX chemotherapy, based on the results of the MRC MAGIC study. Patients were randomized to either standard surgery alone, or surgery with three cycles of ECF (epirubicin, cisplatin, and continuous infusional fluorouracil preoperatively), with a further three cycles post-operatively. Perioperative chemotherapy yielded a statistically significant improvement in PFS and OS (5y survival of 36% versus 23%). The infusional fluorouracil is now usually replaced by the oral fluoropyrimidine capecitabine (ECX).

### Locally advanced disease

- For patients with advanced disease, surgical intervention is sometimes appropriate to relieve symptoms.
- Patients with gastric obstruction, not suitable for resection, can be palliated by means of endoscopic dilatation in the first instance. Some gastric lesions can be stented but displace more frequently than when used for oesophageal cancer.
- Patients with bleeding tumours may have the haemorrhage controlled endoscopically (injection of epinephrine, diathermy, heat probe, argon, clipping). If this fails, the bleeding may be addressed at laparotomy by oversewing or a palliative resection.

### Metastatic disease

- Numerous single-agent and combination chemotherapy regimens have activity in advanced gastric cancer.
- Combination chemotherapy regimens can improve survival in advanced disease, compared with best supportive care.
- The ECF regimen was developed in the UK and has a superior objective response rate (45% versus 21%), median survival (8.9mo versus 5.7mo), and 1y survival (36% versus 21%), compared with FAMTX, which was one of the previously used standard regimens.
- A randomized trial in the UK has compared four regimens in advanced gastric cancer in a 2 × 2 design—comparing infusional fluorouracil with the oral fluoropyrimidine pro-drug capecitabine, and comparing oxaliplatin with cisplatin. Capecitabine was equivalent to infusional fluorouracil, but with the added convenience of oral therapy, thereby removing the requirement for insertion of central venous catheters. Consequently, capecitabine has now replaced infusional fluorouracil in combination chemotherapy regimens in the UK. The combination of epirubicin, oxaliplatin, and capecitabine gave a further improvement in OS, and consequently oxaliplatin is invariably used, instead of cisplatin, in the UK.
- Other agents with activity in advanced gastric cancer include irinotecan and the taxanes (e.g. docetaxel).
- The addition of docetaxel to cisplatin and fluorouracil improves the OS, compared with cisplatin and fluorouracil. However, this regimen is also associated with a significant increase in toxicity.

- Docetaxel results in a statistically significant modest improvement in the OS, compared with supportive care alone, when administered as second-line therapy after previous platinum/fluoropyrimidine chemotherapy.
- The addition of trastuzumab to a cisplatin–fluoropyrimidine chemotherapy backbone further improves the OS to beyond 1y in patients with HER2-positive tumours.

### Further reading

- Allum WH, Blazeby JM, Griffin SM, Cunningham D, Jankowski JA, Wong R; Association of Upper Gastrointestinal Surgeons of Great Britain and Ireland, the British Society of Gastroenterology and the British Association of Surgical Oncology (2011). Guidelines for the management of oesophageal and gastric cancer. *Gut* **60**, 1449–72.
- Bang YJ, van Cutsem E, Feyereislova A, et al. (2010). Trastuzumab in combination with chemotherapy versus chemotherapy alone for treatment of HER2-positive advanced gastric or gastro-oesophageal junction cancer (ToGA): a phase 3, open-label, randomised controlled trial. *Lancet* **376**, 687–97.
- Cancer Research UK (2013). Stomach cancer statistics. Available at: <http://www.cancerresearchuk.org/cancer-info/cancerstats/types/stomach>.
- Cunningham D, Allum W, Stenning S, et al. (2006). Perioperative chemotherapy versus surgery alone for resectable gastroesophageal cancer. *N Engl J Med* **355**, 11–20.
- Cunningham D, Starling N, Rao S, et al. (2008). Capecitabine and oxaliplatin for advanced esophago-gastric cancer. *N Engl J Med* **358**, 36–46.
- Fuccio L, Zagari RM, Eusebi LH, et al. (2009). Meta-analysis: can *Helicobacter pylori* eradication treatment reduce the risk of gastric cancer? *Ann Intern Med* **151**, 121–8.
- MacDonald JS, Smalley SR, Benedetti J, et al. (2001). Chemoradiotherapy after surgery compared with surgery alone for adenocarcinoma of the stomach or gastroesophageal junction. *N Engl J Med* **345**, 725–30.
- Parkin DM, Boyd L, Walker LC (2011). The fraction of cancer attributable to lifestyle and environmental factors in the UK in 2010. *Br J Cancer* **105** (Suppl 2), S77–81.
- Webb A, Cunningham D, Scarffe H, et al. (1997). Randomised trial comparing epirubicin, cisplatin and fluorouracil versus fluorouracil, doxorubicin and methotrexate in advanced oesophagogastric cancer. *J Clin Oncol* **15**, 261–7.



## Small intestinal

### Epidemiology

- Rare, accounting for ~1–2% of all GI tumours.
- The overall UK incidence for small intestinal malignant tumours is 5–9 per million population.
- ~65% of all small bowel tumours are malignant.
- The commonest lesions are adenocarcinoma (45%), neuroendocrine (30%), and lymphoma (15%). Others include GI stromal tumours, leiomyosarcoma, and 2° tumours (melanoma, colonic, ovarian, cervical, lung, breast, and kidney).

### Adenocarcinomas

- Typically occur in patients aged 50–70y.
- Commoner in ♂.
- They are most commonly seen in the duodenum (50%), the majority being periampullary, with 30% in the jejunum and 20% in the ileum.
- Those associated with Crohn's disease are usually ileal in location.
- Adenocarcinomas have also been reported in long-standing ileostomies and ileal conduits.

### Neuroendocrine

- Neuroendocrine tumours are a family of neoplasms. Those arising from the small bowel are most frequently carcinoid tumours and have a peak incidence similar to that of adenocarcinomas but are more common in ♀. Other neuroendocrine tumours arising in the small bowel may produce GI hormones.
- There is a ♂ predominance, with a gender ratio of 1.5:1, and a mean age at presentation of 60y. Gastrin-producing tumours occur at a mean age of 45y and are slightly more frequent in men.
- 40% of GI carcinoids arise from the jejunum or ileum and are second only to the appendix in frequency. Duodenal carcinoids are uncommon.
- ~20% of all GI functional neuroendocrine tumours arise in the duodenum, and only 1% in the jejunum/ileum. Gastrin-secreting tumours are the most common (62%).
- The incidence is on the rise, increasing 3–5-fold over the past 35y.

### Lymphomas

- Lymphomas are seen in patients aged 60–70y, with a slight ♂ preponderance.
- Account for 25% of GI lymphomas.
- Predominantly NHL, with B-cell much commoner than T-cell lymphomas.
- May be 1° small bowel or 2° from systemic lymphoma.
- 1° lymphomas are commoner in patients of Eastern European or Mediterranean origin. They differ from 2° lymphomas in that there is no splenic/hepatic involvement, the white cell count is normal, and there is no extra-abdominal lymphadenopathy (Dawson's criteria).

### Aetiology

#### Adenocarcinomas

- The aetiology is poorly understood, but a low incidence, compared to colon cancer, is believed to be due to a combination of protection

provided by the lymphoid tissue and IgA, a lower bacterial load, more rapid transit time, less mucosal irritation from liquid stool, alkaline content, and higher concentration of detoxifying enzymes.

- Risk factors for adenocarcinomas include low-fibre and high-fat diet, smoking, and alcohol.
- Increased risk associated with Peutz–Jeghers syndrome, Crohn's disease (86-fold risk), coeliac disease, Gardner's syndrome, FAP, juvenile polyposis, and HNPCC. Also higher risk of ileal tumours in cystic fibrosis.

### Neuroendocrine

- A proportion of neuroendocrine tumours have a genetic aetiology, as they are seen in 10% of patients with MEN type 1 and also individuals with neurofibromatosis type 1.

### Lymphomas

- A number of predisposing factors related to immune dysfunction.
  - *Immunodeficiency syndromes*—Wiskott–Aldrich; severe combined immunodeficiency syndrome; and X-linked agammaglobulinaemia.
  - *Autoimmune disease*—rheumatoid arthritis; systemic lupus erythematosus (SLE); Sjögren's syndrome; Wegener's granulomatosis.
  - *Iatrogenic*—immunosuppressive therapy; chemotherapy.
  - *Infections*—HIV, EBV.
  - *GI disorders*—Crohn's disease; coeliac disease.
- T-cell lymphomas are usually jejunal and associated with coeliac disease.

## Pathology

### Adenocarcinoma

- Believed to arise from adenocarcinomas in an adenoma–carcinoma sequence.
- *Ki-ras* mutations are seen in half of the tumours, mainly those of duodenal origin, whereas *APC* gene mutations are uncommon.
- 60% are well or moderately differentiated, whilst the remainder is poorly differentiated.
- Duodenal tumours tend to be polypoid, whilst jejunal and ileal tumours are larger and annular.
- Patients with a 1° small bowel carcinoma should be monitored for the development of a second malignant tumour, most commonly in the colon.
- Genetic link, as patients with HNPCC have a 4% lifetime risk for adenocarcinoma, this being 100-fold that of the general population. One in 40 patients with Peutz–Jeghers syndrome develops cancers.

### Neuroendocrine

- Arise from enterochromaffin cells, most commonly seen in the submucosa.
- The malignant nature of a carcinoid tumour is based on the lymph node status and the presence of metastases, not on the 1° lesion.
- The malignant potential is based on the size and site of the 1°, with tumours that have metastasized invariably being >2cm in diameter.
- An intense desmoplastic reaction is frequently seen around the 1° tumour, and this can lead to small bowel obstruction itself, as well as the tumour occluding the lumen.

- The 'carcinoid syndrome' arises when a well-differentiated carcinoid tumour metastasizes to the liver and secretes vasoactive amines (histamine, 5-HT, 5-hydroxytryptophan (5-HTP), and 5-hydroxyindoleacetic acid (5-HIAA)) that reach the systemic circulation via the hepatic veins. Occurs in up to 10% of patients.
- Clinical manifestations of the carcinoid syndrome, including flushing, diarrhoea, bronchial constriction, and right-sided valvular heart disease.
- Up to a third have a synchronous non-carcinoid GI 1° tumour.

### *Lymphoma*

- Extra-nodal marginal zone B-cell lymphomas (previously known as MALTomas) arise from mucosa-associated lymphatic tissue that is particularly rich in the distal ileum.
- Mantle cell lymphomas are more aggressive, present as multiple fleshy nodules, and are seen throughout the small bowel. Early nodal and metastatic spread is common.
- T-cell lymphomas are usually jejunal and associated with coeliac disease.

### **Presentation**

- The overall presentation of small intestinal tumours is variable, the commonest symptoms being pain (65%) and anorexia and weight loss (50%). A quarter of patients will have a palpable mass.
- Modes of presentation include obstruction (25%), perforation (10%), and bleeding/anaemia (10%).

### *Adenocarcinomas*

- Pain is the commonest presenting feature, followed by obstruction, bleeding, and anaemia.
- Duodenal tumours may present with biliary obstruction or bleeding/anaemia, but pain due to obstruction is uncommon.

### *Neuroendocrine*

- The presentation of carcinoid is usually either early with vague pain, anorexia, and weight loss, or late with carcinoid syndrome; 15% develop bowel obstruction.
- More proximal tumours are more likely to be incidental findings or associated with symptoms due to hormone production; the commonest is related to gastrin hypersecretion (Zollinger–Ellison syndrome), leading to refractory peptic ulcer disease. Duodenal tumours may also present with jaundice. Ileal tumours are more likely to present with obstruction or carcinoid syndrome.

### *Lymphomas*

- 1° lymphomas present with colicky pain, symptoms and signs of obstruction, or GI bleeding.
- 2° lymphomas more typically report systemic symptoms such as weight loss, anorexia, and night sweats, although these may also be observed in 1° lymphomas.



### **Diagnosis**

- Small bowel follow-through is the usual 1° investigation and identifies up to 65% of lesions, including mass lesions, mucosal defects, and intussusception.



- Enteroscopy is a useful second-line investigation, in particular, for tumours presenting with bleeding. There are several options, including capsule endoscopy, push enteroscopy, and double balloon enteroscopy. Enteroscopy has the advantage of providing biopsies and allows for therapeutic intervention. However, push enteroscopy is limited to the first 60cm of the jejunum. Capsule endoscopy allows inspection of the entire small bowel, but it is a time-consuming investigation and cannot be used in cases of suspected obstruction.
- CT scanning of the abdomen and pelvis detects mass lesions and also allows assessment of the liver and peritoneum for metastatic disease. For known malignancies, a chest CT scan should also be requested. Carcinoid tumours usually enhance avidly with contrast.
- MRI imaging is preferred by some units for the evaluation of the bowel and also the assessment of liver metastases.
- PET-CT scanning is useful for the staging of lymphomas in particular.
- Patients with suspected carcinoid tumours should have blood chromogranin A levels measured and a 24h urine collection obtained for the determination of 5-HIAA levels. Somatostatin receptor scintigraphy, using radiolabelled octreotide, is also of use, as 90% of carcinoids express somatostatin receptor subtype 2.
- When a carcinoid tumour is diagnosed, consideration should be given to the presence of other familial tumours associated with MEN type 1 and screening guidelines followed (see Chapter 18).

### Staging

- The staging of small bowel carcinoma follows the TNM system (see  <https://cancerstaging.org> to download the TNM staging).
- There is no uniformly accepted staging and grading system for neuroendocrine tumours. The two most commonly used are the American Joint Committee on Cancer (AJCC) and the WHO systems.
- The TNM staging of small bowel neuroendocrine tumours can be downloaded from  <https://cancerstaging.org>.
- The WHO guidelines divide tumours into well differentiated (grades 1 and 2) and poorly differentiated (grade 3), with G1/2 tumours being known as carcinoids and G3 as neuroendocrine carcinomas (see Table 17.2).
- The staging of small bowel lymphomas follows the Ann Arbor system (see Table 24.8).

**Table 17.2** WHO grading of neuroendocrine tumours

Low (G1)	<2 mitoses/10 HPF and $\leq 2\%$ Ki-67 index
Intermediate (G2)	2–20 mitoses/10 HPF and 3–20% Ki-67 index
High (G3)	>20 mitoses/HPF and >20% Ki-67 index

HPF, high-powered field; Ki-67, proliferation index.

Reproduced from Rindi G, Arnold R, Bosman FT *et al.* (2010) Nomenclature and classification of neuroendocrine neoplasms of the digestive system. In Bosman FT, Hruban RH, Theise ND (eds), *WHO classification of tumours of the digestive system*. Lyon: IARC; 13–14, with permission from WHO.

## Treatment

### Adenocarcinoma

*Potentially curable disease: surgical resection*

- The treatment of choice for operable small bowel tumours, and 70–80% are resectable at presentation.
- For lesions of the proximal duodenum, a pancreatoduodenectomy is required, but, for the remainder of the duodenum, jejunum, and ileum, segmental resection is usually possible. For distal ileal lesions, a right hemicolectomy is often appropriate.
- Adjuvant/neoadjuvant therapy.
- The 5y survival of small bowel adenocarcinoma ranges from 65% for duodenal, jejunal, and proximal ileal tumours to 30% for distal ileal cancers.

*Locally advanced and metastatic disease*

- Palliative resection is sometimes worthwhile for locally advanced or metastatic tumours that are obstructing or bleeding.
- Palliative chemotherapy regimens are similar to those used to palliate advanced colon cancer.

### Neuroendocrine

*Potentially curable disease*

- Resection, where possible; however, metastases are common at presentation, even when 1° tumours are small.
- Small bowel carcinoids are frequently multifocal, and so a careful assessment of the whole bowel is required at laparotomy.
- The segment of the bowel should be excised with a good margin, and lymph nodes draining the excised segment should be removed en bloc.
- There is a benefit in resecting the 1° tumour, even in the presence of metastatic disease. However, if the carcinoid syndrome is present, then the patient should ideally receive octreotide (200 micrograms tds s/c), together with hydration and careful electrolyte management, to prevent a carcinoid crisis prior to surgical intervention. If a crisis does arise, it must be treated immediately with IV octreotide (300 micrograms), followed by an infusion of 50–100 micrograms/h.
- The 5y survival for neuroendocrine tumours of the small bowel is in the order of 60–75%.

*Adjuvant/neoadjuvant therapy*

- Somatostatin analogues are effective in controlling symptoms in patients with the carcinoid syndrome, in particular diarrhoea and flushing, with a reduction in biochemical markers in up to 40% of patients, stabilization of tumour growth in ~24–57% of patients, but with partial or complete tumour responses in <10% of patients. They block all GI hormones and so reduce the transit time and intestinal secretions, thus predisposing patients to malabsorption and gallstone formation. Doses commence at 50 micrograms tds and can increase to 500 micrograms tds. Depot preparations are available, once the symptoms are controlled.
- Interferon alfa is used in patients with symptoms, despite maximal somatostatin analogue therapy. Results are variable, with symptom control in ~50%, but low tumour response rates.

- Combination chemotherapy (one or more of streptozotocin, fluorouracil, doxorubicin carboplatin, paclitaxel, and topotecan) regimens are usually favoured for the management of faster-growing disease, and aggressive and atypical carcinoid tumours, but evidence for such therapy is limited.
- Both bevacizumab (VEGF inhibitor) and sunitinib (TKI) can improve PFS and OS in patients with pancreatic neuroendocrine tumours, compared to supportive care, but, so far, there have been no studies for small bowel carcinoids.

#### Locally advanced and metastatic disease

- Liver metastases may be suitable for resection in a small percentage of patients.
- Lesions not suitable for resection can be treated by means of RFA, with open/laparoscopic or percutaneous techniques.
- Liver transplantation can be considered for patients with liver-limited high-burden disease.
- Hepatic artery embolization may be used to palliate painful, refractory liver metastases.

#### Lymphoma

- The treatment of lymphoma depends on the subtype and stage.
- *Marginal*—stage I disease often responds to *H. pylori* irradiation therapy. Stage II lymphoma is treated by means of resection and post-operative chemotherapy (see  Management, p. 588). Stages III and IV disease is treated by means of combination chemotherapy.
- *Mantle*—combination chemotherapy, including rituximab, is the mainstay of treatment. Surgery is considered in diffuse disease because of risk of perforation during chemotherapy. Bone marrow transplantation may be considered in younger patients.
- The 5y survival for small bowel lymphoma is in the order of 25% but varies according to subtype.

#### Further reading

- Anzidei M, Napoli A, Zini C, Kirchin MA, Catalano C, Passariello R (2011). Malignant tumours of the small intestine: a review of histopathology, multidetector CT and MRI aspects. *Br J Radiol* **84**, 677–90.
- Delle Fave G, Kwekkeboom DJ, Van Cutsem E, et al. (2012). ENETS Consensus Guidelines for the management of patients with gastroduodenal neoplasms. *Neuroendocrinology* **95**, 74–87.
- Ghimire P, Wu GY, Zhu L (2011). Primary gastrointestinal lymphoma. *World J Gastroenterol* **17**, 697–707.
- International Agency for Research on Cancer. Tumours of the small intestine. Available at:  <http://www.iarc.fr/en/publications/pdfs-online/pat-gen/bb2/bb2-chap4.pdf>.
- Öberg K, Knigge U, Kwekkeboom D, Perren A; ESMO Guidelines Working Group (2012). Neuroendocrine gastro-entéro-pancreatic tumors: ESMO Clinical Practice Guidelines for diagnosis, treatment and follow-up. *Ann Oncol* **23** (Suppl 7), 124–30.
- Rindi G, Arnold R, Bosman FT, et al. (2010). Nomenclature and classification of neuroendocrine neoplasms of the digestive system. In: Bosman FT, Hruban RH, Theise ND, eds. *WHO classification of tumours of the digestive system*. Lyon: International Agency for Research on Cancer, pp. 13–14.
- Strosberg J (2012). Neuroendocrine tumours of the small intestine. *Best Pract Res Clin Gastroenterol* **26**, 755–73.
- Yao J, Hassan M, Phan A, et al. (2008). One hundred years after 'carcinoid': epidemiology of and prognostic factors for neuroendocrine tumors in 35,825 cases in the United States. *J Clin Oncol* **26**, 3063–72.

## Hepatic

The two commonest 1° hepatic tumours are HCC and intrahepatic cholangiocarcinoma, accounting for 75% and 20% of 1° tumours, respectively, in the UK. HCCs will be discussed in this section, and cholangiocarcinomas in  Biliary tract, p. 376. Liver metastases, the commonest indication for liver resection in Western countries, are also considered in this section.

### Hepatocellular carcinoma

#### Epidemiology

- The fifth commonest cancer worldwide, with >600 000 cases diagnosed annually, and the third commonest cause of cancer deaths.
- The gender ratio in the UK is 5:3, but, in high incidence areas, the ♂:♀ ratio is as high as 7:1.
- Presents in the sixth decade of life in the Western world, with 70% of cases in the UK aged 65y or older. In high incidence regions, HCCs are frequently seen in the 20–50y age range.
- In the UK, the incidence and mortality rates are similar, with roughly 4000 registrations and deaths annually.
- There is marked geographical variation, with the highest incidence (over 100 cases per 100 000 people) in parts of Southern Africa and Eastern and South Eastern Asia. In Europe, Greece, Italy, France, and Spain have the highest incidence rates. More than 80% of cases are in developing countries.
- The incidence is increasing in the UK, Europe, and North America, with a 3-fold rise due to the rising incidence of HBV and HCV, and increased alcohol consumption. HCCs developing on a background of fatty liver disease are likely to be responsible for the next spike in incidence in Western populations.

#### Aetiology

- >90% of cases arise in patients with chronic liver disease or cirrhosis. The risk is greatest with viral and alcohol-related cirrhosis, but also for cirrhosis of other aetiologies, including 1° biliary cirrhosis (6× risk).
- HBV and HCV account for 85% of HCC cases worldwide.
- HBV is associated with a 100-fold risk of HCC, with an annual risk for the development of HCC in HBV-related cirrhosis of 3–8%. Nationwide, vaccination of infants in Taiwan in the 1980s reduced the prevalence of HBV carriers in childhood from 15% to 1% and reduced the incidence of HCC by 60%, compared with children who had not been immunized.
- HCV is the commonest aetiological factor in low prevalence countries, and the risk is related to the viral load. HCV is associated with a 30-fold risk for the development of HCC. Overall, up to 30% of HCV patients develop HCC, with a latency period of 30–50y. The annual risk of HCC in HCV cirrhosis is 1–7%.
- Ingestion of aflatoxin B1 from *Aspergillus flavus* fungus, found in mouldy grain and cereals. Usually seen in high HBV prevalence areas, so may be acting as a co-carcinogen.

- Alcohol-induced liver disease is associated with a 5-fold risk for heavy drinkers, and an annual transformation risk of 1–4%. Alcohol also doubles the risk of HCC in patients with HBV/HCV. HCCs arising in alcohol liver disease represent 9% of cases in the UK.
- Obesity and the metabolic syndrome are the main risk factors for non-alcoholic fatty liver disease, and this, in turn, is associated with a significant rise in the incidence of HCC in Western populations. Diabetics have a 68–88% increased risk of HCC, independent of other risk factors.
- Other liver diseases associated with HCC include haemochromatosis (7–9% per year), porphyria, alpha-fetoprotein (AFP); Wilson's disease, and tyrosinaemia.
- Smoking is believed to be an associated factor in 23% of HCCs in the UK, with a 50% increased risk, compared to non-smokers.
- Patients with a positive family history have a 150% increased risk of HCC.
- Radiation exposure is said to account for 1% of HCCs in the UK.
- Immunosuppression, both HIV (5× risk) and iatrogenic with post-transplant immunosuppression (2× risk).
- 5% of hepatic adenomas undergo malignant transformation, with the risk greatest for adenomas >5cm in size. Adenomas, in turn, are linked to use of the oral contraceptive pill and anabolic steroids.
- There appears to be a genetic component, as HCC is linked to several rare inherited hepatic disorders—haemochromatosis (7–9% per year), type 1 glycogen storage disease (in pre-existing adenomas),  $\alpha$ -1 antitrypsin deficiency ( $\sigma$  homozygotes), hereditary tyrosinaemia (18–35% of patients), hypercitrullinaemia (14% of patients), porphyria cutanea tarda (7–47% of patients), Wilson's disease, hereditary haemorrhagic telangiectasia, ataxia–telangiectasia, intrahepatic biliary atresia, congenital hepatic fibrosis, and Byler's syndrome.

### Pathology

- Tumours are described according to whether they are unifocal or multifocal. Genetic analyses have shown the independent development of multifocal nodules, such that they do not represent intrahepatic metastases. Multicentric HCCs are usually small, have a well-differentiated periphery, but varying pathology. They have a high rate of local recurrence, even after curative resection.
- Most HCCs associated with cirrhosis show an expansile growth pattern with a fibrous capsule and intra-tumoral septae, whereas those in non-cirrhotic livers do not usually have a capsule and are generally larger at presentation. Haemorrhage and necrosis are commonly seen within HCCs.
- The tumour cells resemble hepatocytes, and the stroma is composed of sinusoid-like blood spaces, lined by endothelial cells. Microscopically, several different architectural patterns are observed: trabecular—most common in well- and moderately differentiated HCCs; pseudoglandular, also common; compact, appears solid; and scirrhous, rare.
- The degree of differentiation has prognostic importance; 40% of tumours of 1–3cm have two or more grades, with the lesser degree of

differentiation centrally surrounded by a better grade peripherally. The percentage of well-differentiated HCCs decreases, as size increases.

- Well—usually <2cm, minimal atypia, an increased nuclear:cytoplasmic ratio, mainly trabecular or pseudoglandular pattern, and fat is frequently seen.
- Moderate—usually >3cm, mainly trabecular or pseudoglandular, but sometimes a solid pattern, abundant eosinophilic cytoplasm and large round nucleoli with distinct nucleoli, and bile often seen.
- Poor—solid or scirrhous pattern, no distinct sinusoid-like blood spaces, increased nuclear:cytoplasmic ratio, prominent polymorphism, and giant cells.
- Tumour progression occurs through a number of mechanisms—local expansion and compression of surrounding structures, intrahepatic metastases, vascular invasion to the portal veins (35–80%) or hepatic veins (20%), and via the biliary tree (5%). Distant metastases are not uncommon, with sites including the lungs, lymph nodes, and bone.
- The carcinogenesis of HCC is not completely understood. However, it is clear there a progression from a normal liver through cirrhosis to dysplastic nodules and then HCC. The pathogenesis of HCC includes at least four distinct genetic processes: oncogene activation (*myc*, *K-ras*, *BRAF*); tumour suppressor inactivation (*p53*, *Rb*), reactivation of developmental pathways (Wnt, hedgehog) and growth factors and their receptors (TGF $\alpha$ , IGF receptor). It appears as though oxidative stress and inflammatory processes may be important in triggering these events.
- Fibrolamellar HCC is a rare variant, accounting for 5% of all HCCs. It typically affects patients at an average age of 25y, without gender bias. AFP is normal, and radiological imaging reveals a typical central scar. Can be differentiated from standard HCC, as they stain for CK7 and CD68. The background liver is not cirrhotic, and so resection is preferred to transplantation, but either modality may be used. The 5y survival is >75%.
- Other rare malignant hepatic neoplasms include epithelioid haemangioendothelioma, lymphoma, angiosarcoma, and hepatocellular cholangiocarcinoma.

#### Presentation

- In areas of high HBV prevalence, transmission often follows a vertical pattern, from mother to child, and hence the need for immunization programmes to prevent chronic HBV and the development of HCC. In these areas, patients develop HCCs at a young age, and they are usually associated with advanced liver disease and decompensation, so rarely operable.
- In patients with coexisting cirrhosis who are in screening programmes, the finding of an HCC is often an incidental finding. HCCs are also incidental findings in transplant specimens. With modern imaging, most HCCs are detected preoperatively, but unrecognized small tumours are not uncommon.
- Symptoms of HCCs are vague, in particular on a background of chronic liver disease. Some degree of abdominal pain is reported by 50–95% of patients but varies in severity. An acute onset of severe pain may represent intraperitoneal bleeding due to tumour rupture, this being

the presentation of 10% of HCCs in high prevalence regions. These patients are often shocked, although bleeding also occurs on a more chronic basis. Other symptoms include abdominal distension, weight loss, anorexia, and malaise. Patients also report increased abdominal swelling and fever. A small number of patients present with variceal bleeding which is believed to be due to tumour thrombus elevating the portal pressure. Jaundice is also noted and, in 90% of cases, is due to parenchymal insufficiency due to extensive tumour infiltration, and most are dead within 10wk of presentation. In a small percentage, the tumour may have invaded the biliary tree, there may be haemobilia clotting the bile duct, or there may be isolated compression of the biliary tree.

- Clinical examination in patients with cirrhosis may reveal ascites and stigmata of portal hypertension. An abdominal mass may be palpable. In patients with no known history of liver disease, such findings are more striking. A caval thrombus may propagate through the hepatic veins into the inferior vena cava (IVC) and lead to Budd–Chiari syndrome, with sudden onset of severe pitting oedema. Extra-hepatic metastases are present in up to 40% of patients at presentation. Osteolytic bone lesions cause pain as a result of pathological fractures and nerve compression, whilst lung metastases lead to dyspnoea, cough, and haemoptysis.
- Paraneoplastic syndromes are seen in around 20% and are present in 10% at presentation. The two commonest manifestations are hypoglycaemia and hypercalcaemia.

### Investigation

- The American Association for the Study of Liver Diseases (AASLD) and the European Association for the Study of the Liver (EASL) guidelines are used as a basis for planning treatment. The two are very similar and vary only on the size for instigating further investigations, the EASL guidelines (see Fig. 17.1) being a little more conservative. The UK-specific BSG guidelines are currently being updated.
- Ultrasound scan (USS) is the 1° modality for assessing the liver, and lesions appear as hypo- or hyperechoic nodules. It allows the documentation of the size, number, and location of lesions present. It also allows the identification of ascites and portal hypertension. Contrast-enhanced USS is useful in differentiating benign and malignant lesions in cirrhotic livers. USS is also used for screening patients at high risk of HCC.
- Triple-phase CT or MRI with contrast is used to better assess the local extent of the tumour, including the presence of vascular invasion and tumour thrombi. On cross-sectional imaging, there are three distinct patterns—expansile, infiltrating, and multifocal. These modalities frequently identify additional lesions not seen on USS. They also allow better assessment for the presence of cirrhosis and portal hypertension. In addition, cross-sectional imaging documents the presence of lymphadenopathy and extra-hepatic metastases, including lung and bone lesions. CT is also used to assess the functional liver remnant (FLR) and determine if portal vein embolization (PVE) is required prior to resection (see  Investigation, p. 351).

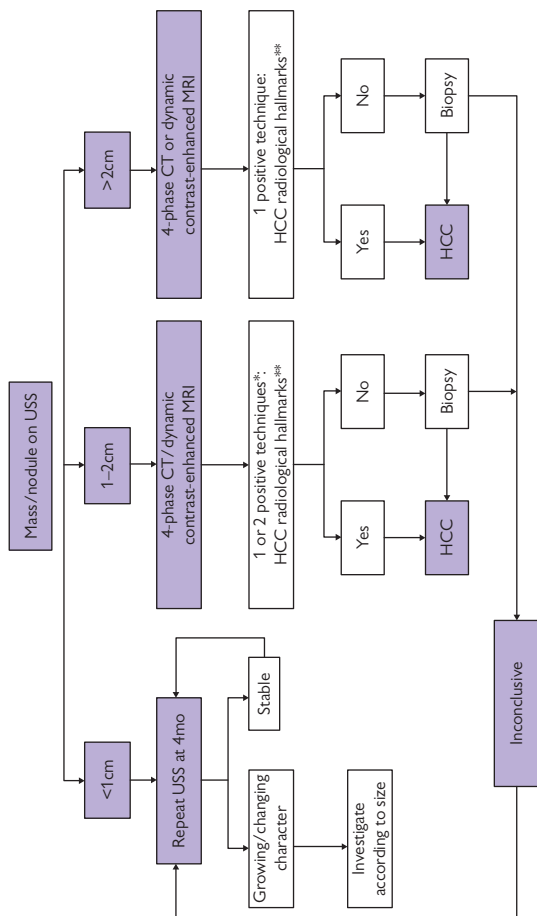

**Fig. 17.1** EASL guidelines for the investigation of HCC. \*One imaging technique only recommended in centres of excellence with high-end radiological equipment. \*\*HCC radiological hallmark: arterial hypervascularity and venous/late phase washout.

Reproduced from EASL-EORTC Clinical Practice Guidelines: Management of hepatocellular carcinoma. *Journal of Hepatology* 2012; vol. 56: 4, 908-943, reproduced under Open Access License.



- Identification of HCC on two modalities is usually adequate for diagnosis, in particular if AFP is elevated, and a histological diagnosis is not normally required prior to treatment. However, a biopsy may be carried out on occasions where the radiological diagnosis is in doubt.
- It is important to assess the synthetic function of the liver, as the degree of impairment of the liver function influences treatment decisions (see Table 17.3).
- AFP is increased in 40–60% of HCCs. AFP >400ng/mL is likely to represent HCC, and AFP levels correlate with the tumour stage. However, a normal AFP does not exclude HCC; indeed, AFP is not elevated in all patients with HCC and is normal in most patients with the fibrolamellar variant of HCC.
- Indocyanine green (ICG) clearance is used to provide a functional assessment of the liver and is the basis of determining suitability for resection (see Fig. 17.2).
- PVE is used to increase the volume of the FLR prior to resection in patients with Child–Pugh grade A cirrhosis. If the ICG clearance is <10%, then PVE is indicated if the FLR is  $\leq 40\%$ . For an ICG clearance of 10–15%, then PVE is indicated for an FLR of  $\leq 50\%$ . ICG is not indicated for an ICG clearance of >20%.

### Staging

- Staging of HCCs is usually performed according to the TNM classification (see <https://cancerstaging.org> to download the TNM staging). The Cancer of the Liver Italian Program (CLIP), Japanese integrated score (JIS), and Okuda scores are also used by some groups.

**Table 17.3** Child–Pugh scoring system for degree of hepatic impairment

	1	2	3
Encephalopathy (grade)	None	Mild	Marked
Albumin (g/L)	>35	28–35	<28
Ascites	None	Mild	Marked
Prothrombin time prolonged (s)	1–4	4–6	>6
Bilirubin (micromole/L)	<34	34–50	>50

Grade A, <7—good operative risk.

Grade B, 7–9—moderate operative risk.

Grade C, >9—poor operative risk.

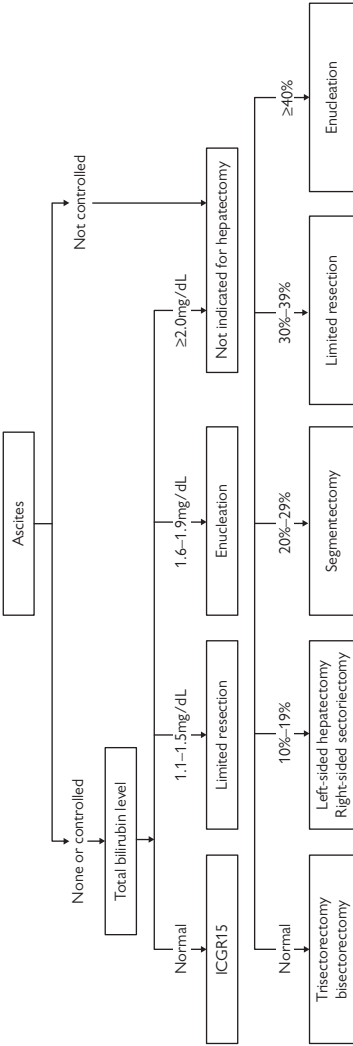

Fig. 17.2 Makuuchi schema for determining resectability, based on ICG clearance. Reproduced with permission from Professor M. Makuuchi.



## Treatment of hepatocellular carcinoma

### Potentially curable disease

#### *Surgical resection*

- ~5% of all patients are suitable for curative treatment.
- Liver resection and transplantation are both well-established options for the curative treatment of HCC, with the decision dependent on the presence, or not, of concomitant hepatic parenchymal disease and liver function. More recently, the results of ablation have suggested that this is a third option for the provision of long-term survival.
- The Barcelona Clinic Liver Cancer (BCLC) system is widely used to determine management (see Fig. 17.3) and is advocated by AASLD and EASL as a basis for planning treatment. The UK guidelines are currently awaiting an update but previously followed similar principles.

#### *Liver resection*

- The treatment of choice for patients with HCC in the absence of significant hepatic dysfunction, and so used for Child–Pugh A and B patients.
- A full work-up, followed by MDT discussion, is critical to ensure that defined management pathways are followed. Therefore, for HCCs, in addition to the standard preoperative work-up, the hepatic synthetic function must be assessed and classified, the FLR calculated on cross-sectional imaging, and the ICG clearance determined in tailoring care to the individual patient.
- Details of perioperative considerations and surgical technique are provided in  Treatment of colorectal liver metastases, p. 352.
- In modern series, the perioperative mortality is 2–3%. Morbidity is in the order of 40%, increasing as the degree of hepatic insufficiency increases.
- Recurrence rates following resection are ~80% at 5y, with factors associated with recurrence, including vascular invasion, tumour grade, and AFP level.
- Local recurrence may be treated by further resection or ablation. Liver-limited recurrence within the Milan criteria can be treated by salvage transplantation, yielding 5y survival of 70%.

#### *Liver transplantation*

- Transplantation is the treatment of choice in the presence of cirrhosis. It has the advantage of removing all HCCs and also potentially pre-neoplastic nodules. Transplantation also prevents complications related to end-stage liver disease.
- The main issue with transplantation has been the lack of availability of cadaveric organs. The increasing utilization of living-related organ donors has meant that, in such cases, an operation may be planned, with much shorter waiting times and hence less disease progression. For patients with HCCs on a waiting list for transplantation, RFA and trans-arterial chemoembolization (TACE) may be used as bridging therapies.

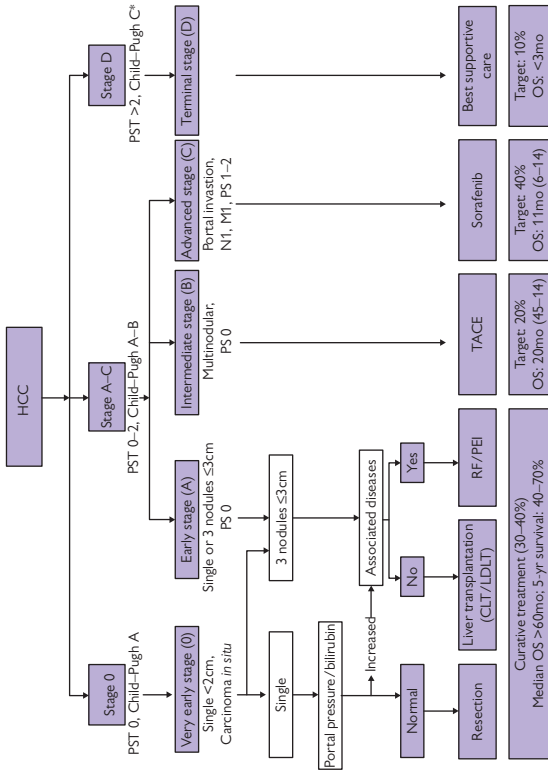

Fig. 17.3 BCLC schema for the management of HCC.

Reproduced from EASL-EORTC Clinical Practice Guidelines: Management of hepatocellular carcinoma, *Journal of Hepatology* 2012 vol. 56: 4, 908-943, reproduced under Open Access License.

- Suitability traditionally based on the Milan criteria that recommend transplantation for a single nodule of  $\leq 5$ cm or up to three nodules of up to 3cm in diameter. For both options, there should be no extra-hepatic disease and no evidence of vascular invasion.
- Now, the San Francisco criteria are commonly applied, allowing more patients to undergo transplantation. These allow the transplant of a single tumour of  $\leq 6.5$ cm or 2–3 lesions not exceeding 4.5cm with a total diameter of  $\leq 8$ cm. Again, extra-hepatic disease and vascular invasion are contraindications.
- The Model for End-stage Liver Disease (MELD) criteria determine the priority on the waiting list, based on a formula incorporating bilirubin, the international normalized ratio (INR), and creatinine. Patients with HCCs (who fit the Milan criteria) are awarded additional points, so that they are at a more favourable position on the waiting list, for organ allocation, thus decreasing the time to transplant and improving the outcome for this cohort.
- Assessment for transplantation is a detailed process, conducted by hepatologists and surgeons, with input from a number of allied disciplines. Cardiorespiratory performance and renal function are important considerations, as is the nutritional status. If a living-related transplant is being considered, then the donor must also undergo stringent assessment.
- There are numerous different techniques, but the basis of the operation is hepatectomy, followed by an anhepatic phase, followed by implantation. In the presence of severe portal hypertension, many surgeons would perform porto-caval bypass, whilst some utilize axillo-femoral bypass. When transplanting for HCC, attempts are made to limit mobilization of the liver during dissection. During the anhepatic phase, any residual synthetic ability the patient had will be lost, and the anaesthetist monitors coagulation profiles by thromboelastography and administers products, as directed by need. The first anastomosis is the vena cava, and, in the presence of HCC, most transplant surgeons excise the native IVC. Portal and hepatic arteries are then reconstructed and finally the bile duct, usually with an end-to-end anastomosis or a Roux-en-Y loop. Given the regenerative capacity of the liver, a donor cadaveric organ can be split to supply two recipients.
- In modern series, the perioperative mortality of transplantation is  $< 3\%$  and should be  $< 10\%$  at 1y. Post-operative morbidity is common, and major complications are seen in 25% and summarized in Table 17.4.

For living-related donors, there is a  $< 1\%$  risk of mortality, and so donor assessment and post-operative care are critical. Morbidity is in the order of 40%, increasing as the degree of hepatic insufficiency increases.

- Recurrence rates, following transplantation, are around 10–20% at 5y but are often not amenable to further attempts at cure.

Table 17.4 Complications of liver transplantation

Graft-specific	
Parenchyma	Early—1° non-function, acute rejection, ischaemia–reperfusion injury, chronic rejection Late—chronic rejection, disease recurrence (HCC or associated liver disease)
Biliary	Bile leak, anastomotic stricture, ascending cholangitis
Hepatic artery/portal vein	Thrombosis, stenosis Systemic immunosuppression Infection—local or systemic Drug-related toxicity—cardiovascular, renal, neurological, bone Post-transplant malignancies

### Ablation

- Traditionally, percutaneous alcohol injection and cryoablation were the main ablative therapies and were not considered a curative option. However, the development of RFA has changed the role of ablation, and RFA is now the mainstay ablative therapy due its greater efficacy. Microwave technology is also being used and may have further benefits.
- RFA is based on the use of an alternating electrical current to cause frictional heating, leading to coagulative necrosis and tissue dessication.
- Evidence would suggest that, for BCLC very early and some early-stage tumours, RFA is effective, offering cure in selected patients (although further data are required to confirm this) or at least a bridge to resection or transplantation.
- RFA may be performed percutaneously in the radiology suite or during an open or laparoscopic operation. The procedure involves inserting an ablation catheter into the tumour under ultrasound control. The number of ablations required to treat a lesion will depend on its size and accessibility, as well as the type of device used, as they differ in their characteristics. Tumour seeding is minimized by burning the needle tract, as it is withdrawn. Care must be taken not to burn too close to the bile ducts, as this may lead to stenosis or rupture of the bile duct, with subsequent biloma formation. Major vessels exert a cooling effect due to the 'heat sink' effect which may reduce the efficacy of the RFA. For subcapsular lesions, the risk of bleeding and tumour seeding are greater.
- The peri-procedural mortality of RFA is in the order of <0.5%, with an overall complication rate of around 5%, including biliary injury, colonic injury, bleeding (subcapsular haematoma, haemoperitoneum), respiratory (pneumothorax, haemothorax, hydrothorax, pleural effusion), infection (liver abscess, wound, peritonitis), and needle track seeding. Up to one-third of patients experience a post-ablation syndrome, consisting of a flu-like illness with low-grade fever, delayed pain, malaise, myalgia, nausea, and vomiting. It is usually self-limiting, resolving in 7–10 days.

- The main downside to RFA is a high local recurrence rate, reported to be 83% at 4y in one prospective study. Results of percutaneous RFA, in terms of recurrence and survival, are inferior to RFA performed under direct vision.
- The OS for HCC is in the order of 5% at 5y. Following liver resection, the 5y survival is around 70%, and a similar success is reported, following transplantation (up to 75%). The results of RFA for HCC at 40–70% approach those of resection in some series, but a recent meta-analysis has shown that, whilst the early morbidity of resection is greater, the long-term outcomes, in terms of recurrence and survival, are superior for resection.
- A number of factors are associated with prognosis, following resection/transplantation for HCC, the most commonly reported in multivariate analyses being the presence of vascular invasion, the tumour stage, the tumour grade, and the AFP level.

#### *Adjuvant and neoadjuvant therapy*

- No adjuvant or neoadjuvant therapies are recommended for HCC, although both approaches are the subjects of ongoing research studies.

#### **Locally advanced and metastatic disease**

- Ablative techniques (as described in  Ablation, p. 347) may be used to treat unresectable locally advanced disease and help in the palliation of metastatic disease.
- Two, out of seven, RCTs have shown a survival benefit for TACE, compared with conservative management, which is confirmed by a meta-analysis of these seven studies.
- Patient selection for TACE is crucial to avoid treatment-induced liver failure.
- Most patients are not suitable for surgery, percutaneous ablation, or TACE, or develop progressive disease after these interventions.
- Cytotoxic chemotherapy regimens have low objective response rates and no survival benefit in advanced disease.
- The multi-targeted TKI sorafenib significantly improves the median OS (10.4mo), compared with placebo (7.9mo;  $p < 0.001$ ), in patients who are not suitable for, or have progressed following, surgery or loco-regional therapy and with Child–Pugh liver function class A. There was also a significantly improved median time to objective disease progression (5.5mo versus 2.8mo).
- Sorafenib is standard of care in advanced HCC. Other targeted therapies are currently being evaluated, either in combination with sorafenib as first-line therapy of advanced disease or as second-line therapy after sorafenib failure.
- Several other loco-regional therapies, such as radiolabelled microspheres, lipid-based radioisotope formulations, and stereotactic radiotherapy, have been explored. Some are in common use, but evidence for their benefit in RCTs is lacking at this time.



## Further reading

- American Association for the Study of Liver Diseases (2011). *AASLD practice guideline*. Available at: <http://www.aasld.org/practiceguidelines/documents/bookmarked%20practice%20guidelines/hccupdate2010.pdf>.
- Cancer Research UK (2013). *Liver cancer statistics*. Available at: <http://www.cancerresearchuk.org/cancer-info/cancerstats/types/liver/>.
- European Association for the Study of the Liver, European Organisation for Research and Treatment of Cancer (2012). *EASL-EORTC clinical practice guidelines: management of hepatocellular carcinoma*. Available at: [http://www.easl.eu/assets/application/files/d38c7689f123edf\\_file.pdf](http://www.easl.eu/assets/application/files/d38c7689f123edf_file.pdf).
- Farid SG, Morris-Stiff G, Prasad R (2013). Postoperative management after hepatic surgery. *Br J Hosp Med* **74**, C89–93.
- Hirschfield GM, Gibbs P, Griffiths WJ (2009). Adult liver transplantation: what non-specialists need to know. *BMJ* **338**, b1670.
- Kim DY, Han K-H (2012). Epidemiology and surveillance of hepatocellular carcinoma. *Liver Cancer* **1**, 2–14.
- Li N, Wu YR, Wu B, Lu MQ (2012). Surgical and oncologic outcomes following laparoscopic versus open liver resections for hepatocellular carcinoma: a meta-analysis. *Hepatol Res* **42**, 51–9.
- Lin S, Hoffmann K, Schemmer P (2012). Treatment of hepatocellular carcinoma: a systematic review. *Liver Cancer* **1**, 144–58.
- Llovet JM, Burroughs A, Bruix J (2003). Hepatocellular carcinoma. *Lancet* **362**, 1907–17.
- Llovet JM, Ricci S, Mazzaferro V, et al. (2008). Sorafenib in advanced hepatocellular carcinoma. *N Engl J Med* **359**, 378–90.
- Makuuchi M, Kosuge T, Takayama T, et al. (1993). Surgery for small liver cancers. *Semin Surg Oncol* **9**, 298–304.
- Qi X, Tang Y, An D, Bai M, et al. (2013). Radiofrequency ablation versus hepatic resection for small hepatocellular carcinoma: a meta-analysis of randomized controlled trials. *J Clin Gastroenterol* **48**, 450–7.
- Roxburgh P, Evans TRJ (2008). Systemic therapy of hepatocellular carcinoma: are we making progress? *Adv Ther* **25**, 1089–104.
- Shindoh J, Tzeng C-WD, Vauthey J-N (2012). Portal vein embolization for hepatocellular carcinoma. *Liver Cancer* **1**, 159–67.
- Shiraha H, Yamamoto K, Namba M (2013). Human hepatocyte carcinogenesis. *Int J Oncol* **42**, 1133–8.
- Torbenson M (2012). Fibrolamellar carcinoma: 2012 update. *Scientifica* **2012**, 1–15.

## Liver metastases

By far, the commonest tumours metastasizing to the liver are those arising from the colon and rectum. This section will therefore concentrate on colorectal liver metastases (CRLM), and other tumours developing liver metastases will be considered in the chapters relevant to the 1° lesions. There have been great advances in the management of CRLM, and there are now many options, so a detailed MDT discussion of every case is imperative.

### Colorectal liver metastases

#### Epidemiology

- Liver metastases develop in ~50% of patients with colorectal cancer.
- ~ half of CRLM are identified at the time of diagnosis of the 1° (synchronous), and the others are detected later (metachronous), usually within 3y of the index presentation.
- In the UK, there are 42 000 new colorectal cancers diagnosed each year, and so around 20 000 would be expected to present with, or develop, CRLM.
- The gender of CRLM follows that of colorectal cancer, with a ♂ predominance.
- Incidence is highest in countries where colorectal cancer is highest.

#### Aetiology

- The aetiology of colorectal cancer is discussed fully in the chapter on colorectal cancer (see Chapter 15).

#### Pathology

- CRLM are adenocarcinomas and represent stage IV colorectal cancer.
- Liver metastases occur as a result of haematogenous spread from the colorectal 1° and reach the liver via the mesenteric, and subsequently the portal, veins.
- The right portal vein follows on from the main portal vein at a less acute angle than the left, and therefore these metastases are seen more frequently in the right side of the liver (segments 5–8) than the left.
- They usually grow locally within the liver but, unlike HCC, rarely spread via the hepatic veins or invade local structures such as the diaphragm.

#### Presentation

- The majority of synchronous liver metastases are detected during the work-up of the 1° carcinoma.
- With modern imaging techniques, very few are detected intraoperatively at the time of colonic surgery, but this does occasionally occur.
- Some patients, generally those that have neglected symptoms from their 1° tumour, may present with advanced disease and evidence of jaundice and ascites due to volume replacement of the liver parenchyma. These patients may complain of pain, due to capsular stretching, and have a palpable abdominal mass.
- The vast majority of patients with metachronous disease have their tumours diagnosed during follow-up surveillance cross-sectional imaging.

### Investigation

- The majority of patients will have their liver metastases diagnosed on a CT scan, performed either for staging or follow-up of colorectal cancer. It is important that a triphasic CT scan is performed and that imaging includes the chest and pelvis, as well as the abdomen, as extra-hepatic disease may preclude resection. CT provides information on the number and distribution of lesions and their relationship to the hepatic and portal veins, as this is important in determining resectability. CT may also identify the presence of steatotic changes related to irinotecan-based chemotherapy.
- CT also provides information regarding the potential FLR. This computer-generated volume, along with knowledge of the state of the parenchyma in relation to exposure to chemotherapy (or underlying liver disease), will help to determine the safe extent of resection. If the FLR is believed to be inadequate, then PVE or a staged procedure can be considered.
- MRI is preferred by some units to examine the liver, as it has been shown to have a greater sensitivity in the characterization of lesions of <10mm. Contrast-enhanced MRI is also of value in assessing chemotherapy-related toxic injury, in particular sinusoidal obstructive syndrome related to oxaliplatin.
- FDG-PET scanning is now more widely used as a result of studies that suggested it changed management in 10–20% of cases. However, there is currently no consensus for its use.
- Contrast-enhanced ultrasound (CEUS) may also be used to help characterize lesions that appear atypical on cross-sectional imaging.
- Laparoscopy is sometimes applicable if the findings of imaging suggest, but cannot confirm, extra-hepatic metastatic disease that would prevent curative resection.
- Intraoperative ultrasound (IOUS) is routinely used during hepatic surgery to delineate the anatomy. It may also detect lesions not seen on cross-sectional imaging, in particular small lesions. This process is enhanced by the use of a contrast agent.
- Carcinoembryonic antigen (CEA) and carbohydrate antigen 19.9 (Ca19.9) are used to monitor disease recurrence, following resection of the 1° lesions and CRLM. Levels of both tumour markers typically fall to 0, following curative resection, and so an increase indicates recurrence, which is sometimes not always evident on cross-sectional imaging.
- Tissue biopsy is not required prior to treatment; indeed, the risk of needle track seeding means the process is contraindicated. However, a review of the histology of the 1° tumour is advisable (K-RAS, EGFR, and BRAF status), as this may guide adjuvant or neoadjuvant chemotherapy.

### Staging

- There is no TNM staging, or indeed any formal staging, system for CRLM.

## Treatment of colorectal liver metastases

### Potentially curable disease

#### *Surgical resection*

- Resection is the treatment of choice for resectable CRLM. There is no RCT evidence for resection, but the natural history of the disease illustrates that resection is superior to chemotherapy and all other modalities.
- Represents the commonest indication for liver resection in the Western world.
- ~15–20% of patients with CRLM are resectable at the time of presentation. The use of preoperative chemotherapy to downsize CRLM means that up to a further 12–15% may become resectable.
- The definition of resectability has evolved considerably over the past two decades, and CRLM are now considered resectable, as long as they can be resected with a negative histopathological margin (R0) and leaving an adequate volume of functional liver parenchyma. The concept of needing to have a minimum margin of 1cm is no longer considered relevant, and a 1mm margin is considered R0.
- The presence of extra-hepatic disease is no longer considered an absolute contraindication to liver resection. Data from a large series has demonstrated that extra-hepatic intra-abdominal disease, such as hilar pedicle lymph nodes, may be excised, with good long-term survival. Lung metastases from colorectal cancer are now also targeted for resection. There is also early experience with debulking and hyperthermic intraperitoneal chemotherapy, together with liver resection for patients with advanced disease.
- The timing of liver resection is dependent on the treatment plan determined by the MDT review. If the patient is receiving chemotherapy, or neoadjuvant therapy is planned, then surgery should be performed after an interval of 6–8wk because of the risk of associated chemotherapy-related parenchymal damage (sinusoidal obstruction syndrome with oxaliplatin, and steatosis/steatohepatitis with irinotecan). The patient should be re-imaged, prior to finalizing a decision, to insure there has not been disease progression.
- In patients undergoing chemotherapy, the metastases sometimes exhibit a complete response on imaging studies, so it is important that, in such cases, the area or tissue previously occupied by the metastasis is also excised, as histological studies have demonstrated viable tumour cells in 25–45% of cases.
- Data on repeat hepatic resections for CRLM has shown that, as long as an R0 resection is obtained, the long-term results of repeat liver resections are similar to those of the first resection.
- The types of resection performed have changed significantly, with a tendency in most units to perform parenchymal-sparing resections—so-called non-anatomical resections. This equates to excising isolated metastases, when possible, rather than excising large portions of the liver with a large volume of normal parenchyma along the tissue planes (anatomical resection), as this is less of an insult to the patient. The liver anatomy is discussed in terms of Couinaud segments, as illustrated in Fig. 17.4, along with some common operations.

- Many resections can be performed, using either open or laparoscopic techniques, with data suggesting comparable oncological outcomes.
- Liver resections are typically performed under low CVP anaesthesia, as this has been shown to reduce the risk of perioperative haemorrhage, this being an important factor in determining outcome.
- All surgeons perform IOUS to delineate the lesions, examine for additional lesions, and check the anatomy, in particular the hepatic and portal veins. A prospective transection line can also be marked at this time.
- A number of different techniques are used to transect the parenchyma, including parenchymal crushing (often referred to as 'Kellyclasia'), cavitron ultrasonic surgical aspirator (CUSA) device, and water jet dissection. In each case, small vessels are tied or clipped. Other commonly utilized techniques include radiofrequency or bipolar diathermy. The majority of surgeons divide the hepatic pedicles and hepatic veins, using a stapling device after dissecting the parenchyma, but an alternative approach is to isolate and divide the inflow into the segment to be resected upfront, the so-called Glissonian pedicle technique. Although more important for patients with cirrhotic livers, this may assume importance in the future when more patients have chemotherapy-related hepatotoxicity.
- There is debate as to the need to control the inflow and outflow during hepatic resection, but most surgeons use a Pringle manoeuvre (isolation of the hepatic artery and portal vein at the hilum of the liver) in major resections to control the inflow to the liver. Other techniques, including the isolation of the outflow and vena cava, are limited to extended resections.

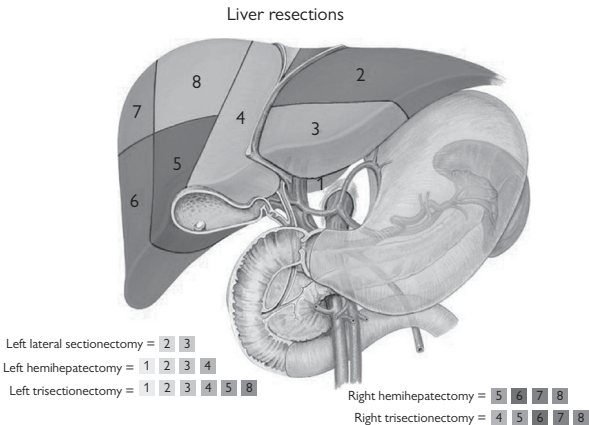

Fig. 17.4 Couinaud segmental anatomy of the liver.

Reproduced with permission from Professor JA Peter Lodge.

- At the end of the procedure, the CVP is increased back to normal levels, and the cut surface of the liver inspected for bleeding points and bile leaks. These are controlled by suture or staple. There is a wide range of haemostatic agents that can be applied to the surface of the liver, and those chosen are consultant preference.
- Only in extended resections where the biliary tree is divided are anastomoses constructed. This is typically done by creating a Roux loop and connecting the open end of the biliary tree to the jejunum.

#### *Synchronous colorectal liver metastases*

- There are several different approaches to patients with synchronous CRLM.
- As long as the 1° tumour is not obstructing (or can be stented), one commonly adopted option would be for neoadjuvant systemic chemotherapy with oxaliplatin or irinotecan-based regimens, together with a mAb (if appropriate), for 3mo. After this time, the patient is re-imaged, with a view to surgery. Liver surgery, in isolation or in combination with resection of the 1°, may be undertaken 5–6wk following completion of chemotherapy in patients who exhibit a partial response or stable disease. Following liver surgery, the patients then have further adjuvant treatment. Patients who progress on first-line treatment are considered poor candidates for liver resection due to early relapse, following surgery, and are generally subjected to second-line treatment, in an attempt to obtain systemic control, before any liver-directed treatment is considered.
- A second option, and one commonly adopted for obstructing lesions, is to perform a combined resection of hepatic and colonic disease, followed by adjuvant therapy, depending on the extent of the liver disease. If the liver disease is extensive, then a colonic resection can be performed, together with resection of a portion of the liver disease, and the remaining hepatic disease can be resected, following adjuvant chemotherapy.
- A further option is to excise the hepatic disease, treat the patient with systemic chemotherapy, and then deal with the 1° lesion.

#### *Metachronous colorectal liver metastases*

- Liver metastases presenting within 1y of resection of the 1° are best regarded as synchronous and treated as such.
- Metachronous disease presenting after 1y is usually treated with surgery upfront, if the disease burden is resectable. This may be by means of a single-stage operation or a two-stage procedure, if there is extensive disease. In the two-stage operation, the first stage may include surgery or RFA.
- The role of neoadjuvant chemotherapy in the presence of resectable CRLM was evaluated in the EORTC 40983 that failed to show any advantage, in terms of survival, over surgery alone.
- Patients whose disease is thought to be unresectable or borderline resectable should have systemic chemotherapy, in an attempt to downsize the disease and allow the patient to undergo surgery.

- The morbidity following resection for CRLM are lower than for HCC at around 20%, as the parenchyma is invariably not cirrhotic. The prevalence of complications does, however, increase with the extent of resection. Most are classified as being minor complications not requiring further surgical intervention. Although the parenchyma is often affected by chemotherapy-related changes, the exact effects these pathological changes have on outcome, in terms of morbidity and mortality, are uncertain.
- The 5y survival in contemporary series is in the order of 50–60%. The results of surgery, following downsizing chemotherapy, is similar to that of upfront resection, and the results of second and third resections are also similar, provided all disease is excised.
- The Fong score (see Box 17.1) is used to provide the prognostic outcome, following the resection of CRLM. Each factor is scored 0 or 1, with a median survival of 74mo reported for patients scoring 0, and 14mo for those with five risk factors.

### Box 17.1 Fong score and outcome of CRLM

- Extension of 1° colorectal carcinoma into the serosa.
- Time to develop CRLM >1y.
- Number of lesions >1.
- Size of largest CRLM >5cm.
- CEA >200ng/mL.

### Locally advanced and metastatic disease

- If the disease is inoperable, due to its extent (inadequate reserve) and involvement of critical anatomical structures (hepatic/portal veins), or when there is progression whilst on chemotherapy, there is no role for surgical resection.
- RFA is recommended by NICE to treat lesions in patients that are unsuitable or unfit for resection.
- In the most recent assessment, NICE stated there were inadequate data to support microwave ablation at present outside of a clinical trial.

## Further reading

- Adam R, De Gramont A, Figueras J, et al. (2013). The oncosurgery approach to managing liver metastases from colorectal cancer: a multidisciplinary international consensus. *Oncologist* **17**, 1225–39.
- Adam R, Delvart V, Pascal G, et al. (2004). Rescue surgery for unresectable colorectal liver metastases downstaged by chemotherapy: a model to predict long-term survival. *Ann Surg* **240**, 644–57.
- Bischof DA, Clary BM, Maitheil SK, Pawlik TM (2013). Surgical management of disappearing colorectal liver metastases. *Br J Surg* **100**, 1414–20.
- Carpizo DR, D'Angelica M (2009). Liver resection for metastatic colorectal cancer in the presence of extrahepatic disease. *Lancet Oncol* **10**, 801–9.
- Folprecht G, Gruenberger T, Bechstein WO, et al. (2010). Tumour response and secondary resectability of colorectal liver metastases following neoadjuvant chemotherapy with cetuximab: the CELIM randomised phase 2 trial. *Lancet Oncol* **11**, 38–47.
- Fong Y, Fortner J, Sun RL, Brennan MF, Blumgart LH (1999). Clinical score for predicting recurrence after hepatic resection for metastatic colorectal cancer: analysis of 1001 consecutive cases. *Ann Surg* **230**, 309–18.
- Garden OJ, Rees M, Poston GJ, et al. (2006). Guidelines for resection of colorectal cancer liver metastases. *Gut* **55** (Suppl III), 1–8.
- Hillingso JG, Wille-Jørgensen P (2009). Staged or simultaneous resection of synchronous liver metastases from colorectal cancer: a systematic review. *Colorectal Dis* **11**, 3–10.
- Huang SY, Aloia TA, Shindoh J, et al. (2013). Efficacy and safety of portal vein embolization for two-stage hepatectomy in patients with colorectal liver metastasis. *J Vasc Interv Radiol* **25**, 608–17.
- International Hepato-Pancreato-Biliary Association (2000). *IHPBA Brisbane 2000 terminology of liver anatomy and resections*. Available at: <https://ihpba.memberclicks.net/liver-resection>.
- Karagkounis G, Torbenson MS, Daniel HD, et al. (2013). Incidence and prognostic impact of KRAS and BRAF mutation in patients undergoing liver surgery for colorectal metastases. *Cancer* **119**, 4137–44.
- Khan AZ, Morris-Stiff G, Makuuchi M (2009). Patterns of chemotherapy-induced hepatic injury and their implications for patients undergoing liver resection for colorectal liver metastases. *J Hepatobiliary Pancreat Surg* **16**, 137–44.
- National Institute for Health and Care Excellence (2009). *Radiofrequency ablation for colorectal liver metastases*. Available at: <http://www.nice.org.uk/guidance/IPG327>.
- National Institute for Health and Care Excellence (2011). *Microwave ablation for the treatment of liver metastases*. Available at: <http://www.nice.org.uk/guidance/IPG406>.
- National Institute for Health and Care Excellence (2011). *Selective internal radiation therapy for non-resectable colorectal metastases in the liver*. Available at: <http://www.nice.org.uk/guidance/IPG401>.
- Nielke MC, Bipat S, Stoker J (2010). Diagnostic imaging of colorectal liver metastases with CT, MR imaging, FDG PET, and/or FDG PET/CT: a meta-analysis of prospective studies including patients who have not previously undergone treatment. *Radiology* **257**, 674–84.
- Nordlinger B, Sorbye H, Glimelius B, et al. (2013). Perioperative FOLFOX4 chemotherapy and surgery versus surgery alone for resectable liver metastases from colorectal cancer (EORTC 40983): long-term results of a randomised, controlled, phase 3 trial. *Lancet Oncol* **14**, 1208–15.
- Sarpel U, Bonavia AS, Grucela A, Roayaie S, Schwartz ME, Labow DM (2009). Does anatomic versus nonanatomic resection affect recurrence and survival in patients undergoing surgery for colorectal liver metastasis? *Ann Surg Oncol* **16**, 379–84.
- Van Cutsem E, Nordlinger B, Cervantes A (2010). Advanced colorectal cancer: ESMO Clinical Practice Guidelines for treatment. *Ann Oncol* **21** (Suppl 5), 93–7.
- Vauthey JN, Kopetz SE (2013). From multidisciplinary to personalized treatment of colorectal liver metastases: 4 reasons to consider RAS. *Cancer* **119**, 4083–5.
- Wong R, Cunningham D, Barbachano Y, et al. (2011). A multicentre study of capecitabine, oxaliplatin plus bevacizumab as perioperative treatment of patients with poor-risk colorectal liver-only metastases not selected for upfront resection. *Ann Oncol* **22**, 2042–8.





## Pancreatic: ductal adenocarcinoma

The majority of pancreatic cancers (98%) arise from the exocrine pancreas, and the vast majority are ductal adenocarcinomas (95%). This chapter will concentrate on these lesions, and neuroendocrine tumours will be covered separately at the end of this section.

### Epidemiology

- The tenth commonest cancer in the UK, with around 8500 new cases per year.
- The gender incidence of pancreatic cancer is similar, and it represents the tenth commonest cancer in men and the eighth commonest in women.
- The incidence rates fell for both men and women over the last decades of the twentieth century, and since they have remained static for ♂ but are increasing in ♀.
- >80% of cases occur in patients aged 60 or over.
- Globally, the highest prevalence rates are seen in Central Europe (Latvia, Hungary, and Czech Republic), Japan, Germany, and the US.
- It is the fifth commonest cause of cancer-related deaths, with almost 8000 deaths annually, <20% surviving beyond 1y, and only 3% surviving 5y.

### Aetiology

- Increased risk of developing pancreatic cancer is associated with smoking. Up to 30% of cancers in the UK are linked directly to smoking. The risk also applies to smokeless tobacco and passive smoking (50% increased risk).
- There is a 2-fold risk in diabetic patients (types I and II).
- Obesity is an important risk factor.
- Important dietary factors, including high consumption of red meat and processed meat. High saturated fat consumption may be important too.
- There is an increased risk of developing pancreatic cancer for patients with chronic pancreatitis of between 2- and 20-fold.
- Post-gastrectomy, there is a 2–5-fold risk presumed to be due to reduced acidity, leading to change in bacterial flora and processing of carcinogens.
- Alcohol consumption is not believed to be a direct risk factor. However, it is linked strongly to chronic pancreatitis.
- Hereditary pancreatitis carries an increased risk of at least 50-fold and an absolute risk of 50% by 75y of age.
- There is a genetic component, with first-degree relatives having a 45% increased risk for pancreatic carcinoma.
- The vast majority of carcinomas arising from the exocrine pancreas are sporadic.
- Sporadic ductal adenocarcinomas have a high frequency of *K-ras* mutations (~90% of cases) and mutations of *p53* in ~50% of cases, and they commonly have mutations of *p21* and loss of expression of *SMAD4*.

- Familial syndromes associated with ductal adenocarcinomas include HNPCC, FAP, Peutz–Jeghers, cystic fibrosis, the familial atypical mole/malignant melanoma syndrome, hereditary pancreatitis, and familial breast/ovarian cancer syndrome associated with *BRCA2* mutations.

### Pathology

- The majority of carcinomas of the exocrine pancreas are ductal adenocarcinomas (95%). Other histopathological types include mucinous, adenosquamous, and carcinomas arising from IPMN, mucinous cystic neoplasms, or solid pseudo-papillary tumours.
- The majority of ductal adenocarcinomas are located in the head of the pancreas (70–80%), and the remaining 20–30% in the body and tail.
- At presentation, 10–20% have localized disease, 20–30% have locally advanced disease, and the remainder have metastatic disease.
- Lymphatic spread is common and occurs early, even with small tumours. Early perineural and vascular invasion are also common.
- Invasion at the posterior border of the pancreas, in relation to the mesenteric artery and vein, is common, thus explaining the high local recurrence rates. New guidelines on specimen reporting take this into account, and recurrence rates in contemporary series are now much greater but correlate much better with outcome.
- In addition to neuroendocrine tumours (discussed later), other rare types include lymphoma (1%) and metastases (breast, lung, melanoma, renal, colon) (<0.5%).

### Presentation

- Clinical manifestations depend on the anatomical location of the 1° tumour.
- The classical presentation of carcinomas arising in the head of the pancreas is with obstructive jaundice, usually in association with weight loss and anorexia that is seen in ~75% of cases. Epigastric pain radiating through to the back (as a result of coeliac plexus infiltration), associated with weight loss and anorexia, is the typical presentation for lesions of the body and tail.
- Malnutrition, as a result of steatorrhea and malabsorption, is also common, being seen in 50% and occurring as a result of occlusion of the pancreatic duct, impairing the flow of the pancreatic juice containing its digestive enzymes.
- Gastric outlet obstruction is evident at presentation or develops in one-third of cases.
- Other clinical presentations include diabetes mellitus in up to 5%; 1% of new-onset adult diabetics have an underlying pancreatic carcinoma; 5% of patients present with acute pancreatitis.
- Signs in early pancreatic cancer are few, hence its late presentation. A palpable gall bladder, in the presence of painless jaundice, is likely to be due to a pancreatic carcinoma (interpretation of Courvoisier's law) and is seen in one-third of patients.
- In advanced disease, clinical examination commonly reveals jaundice, in association with an epigastric mass. Other signs include ascites, supraclavicular (Virchow's) lymph node (Trousseau's sign), migratory thrombophlebitis, and acanthosis nigricans.

### Investigation

- The first investigation performed is usually an USS that confirms biliary obstruction and may identify a pancreatic mass, although bowel gas often impairs the view of the pancreas. It may also identify liver metastases and ascites in advanced disease.
- Cross-sectional imaging of the abdomen, chest, and pelvis with CT is the standard modality for investigating suspected pancreatic cancer. It identifies the 1° tumour and evidence of metastatic disease (liver, peritoneum, chest) and, for potentially resectable tumours, allows an assessment of the relationship between the tumour and superior mesenteric vessels/portal vein.
- Some units prefer assessment with MRI, as this provides similar information to CT.
- EUS is now regularly utilized to obtain better information on the relationship between the tumour and nearby anatomy, in particular the mesenteric vessels. It also allows a biopsy of the tumour to be performed which is important in planning neoadjuvant therapy.
- ERCP is now rarely used as an investigative tool. It is, however, used on a therapeutic basis with temporary or permanent stenting of the duct. Ideally, this should be performed after a decision is made at a pancreatic MDT regarding the patient's suitability for surgical resection. ERCP can also provide brushings to assist in the diagnostic process, if EUS biopsies are inadequate.
- Laparoscopy is used variably, with some surgeons performing routine assessment and others a selective approach. It allows visualization of the peritoneal cavity, the performance of a peritoneal wash, and cytological assessment of the aspirate, and it allows good visualization of the liver surface for small metastases.
- PET-CT scanning is being increasingly used for the staging of ductal adenocarcinomas and is beneficial in identifying metastatic disease.
- Ca19.9 is widely measured in suspected pancreatic cancer and is useful for both diagnosis and monitoring of therapy. False positives are seen in jaundice, biliary disease, and colon and stomach cancers. There is a false negative rate, as 5% of the population do not express the antigen.

### Staging

- Staging of ductal adenocarcinomas is according to the TNM classification (see  <https://cancerstaging.org> to download the TNM staging).

### Treatment

#### Resectable disease

- Resection is possible in only 15–20% of cases.
- Preoperative drainage is now generally avoided, as it is associated with higher post-operative morbidity. It is necessary if the patient has cholangitis or if there is likely to be a delay to surgery and bilirubin is rising.
- Operative mortality should be <5%. Outcome is related to hospital volume, with operative mortality of <2% in high-volume centres, and so it is recommended that all pancreatic surgery be carried out in tertiary referral units following MDT discussion.

- For lesions arising in the head of the pancreas, a pylorus-preserving pancreatoduodenectomy (PPPD), or a Whipple's procedure, is usually performed. For lesions of the body and tail, a distal pancreatectomy is the operation of choice. A total pancreatectomy is occasionally performed for multifocal disease.
- There is increasing evidence that venous resection is of value in order to obtain a clear margin in selected patients, but arterial resection is not advocated.
- Pancreatic surgery has traditionally been formed through a laparotomy, but recent developments in minimally invasive surgery have meant that laparoscopic resections are being performed. Most HPB units now perform distal pancreatectomies laparoscopically, and experience with PPPD is growing.
- Post-operative morbidity is common, being seen in around 40% of cases and include:
  - pancreatic fistula—incidence of 10–30%. Commoner with soft glands and small ducts. Graded A–C, of which ~10% are clinically significant. Octreotide appears to reduce the incidence of pancreatic fistula
  - delayed gastric emptying—incidence of 20–40%. Graded A–C, of which 40% are clinically relevant
  - bleeding—incidence of 5%, but associated with high mortality rate. Graded A–C, of which 60% require clinical intervention
  - biliary and enteric leaks are less common and do not have any specific classification systems
  - intra-abdominal abscesses occur 2° to leaks and can usually be managed percutaneously.
- All the above major complications are commoner after resection of the pancreatic head.
- Pancreatic insufficiency—common after pancreatic surgery and often requires enzyme supplementation.
- Diabetes—incidence varies with the type of surgery and indication for surgery. Commoner after distal pancreatectomy due to the distribution of islet cells.
- Cardiorespiratory and thrombotic complications are also common after major pancreatic resections, and appropriate preoperative work-up and perioperative prophylaxis are required.
- There has been significant debate about the techniques in pancreatic resection and how these impact morbidity. The current evidence would suggest:
  - pylorus-preserving versus Whipple resection—there would appear to be little difference in the two techniques on a meta-analysis. A large, hopefully definitive, study is under way
  - pancreaticogastrostomy versus pancreaticojejunostomy reconstruction—a gastric anastomosis to the pancreas may reduce the incidence of pancreatic fistula. If a pancreaticojejunostomy is performed, invagination reduces the incidence of fistula, when compared to a duct-to-mucosa anastomosis
  - antecolic versus retrocolic gastroenterostomy—the choice of method does not appear to impact the prevalence of delayed gastric emptying

- standard versus extended lymphadenectomy—the extended operation does not improve survival but is associated with increased morbidity, and it is not recommended as standard of care
- stent versus no pancreatic stent—internal pancreatic duct stenting does not appear to reduce the incidence of pancreatic fistula, but new data suggest that external drainage may be useful in this regard, in particular for soft pancreas with small ducts.
- Surgical resection is the only chance of cure, but survival remains poor after surgery alone for adenocarcinoma of the head of the pancreas—the median survival is 20mo, the 5y survival 20–25%. Ductal carcinomas of the body do worse due to local infiltration, making the vast majority unresectable.

#### *Adjuvant/neoadjuvant therapy*

- The ESPAC-1 trial demonstrated a significant benefit from the use of adjuvant (post-operative) chemotherapy using six cycles of fluorouracil and FA administered in a modified Mayo clinic schedule. There was a significant improvement in the median, 2y, and 5y survival, with chemotherapy (21mo, 40%, 21%, respectively), compared with observation alone (15.5mo, 30%, 8%, respectively). There was no benefit for post-operative chemo-radiotherapy.
- The benefits of post-operative chemotherapy have been confirmed in a subsequent meta-analysis of five RCTs.
- The ESPAC-3 study demonstrated similar PFS and OS with gemcitabine, compared with fluorouracil and FA, in the adjuvant setting. There are significant variations in practice throughout the world. In the US, use of radiotherapy is far commoner than in most European centres.

#### *Locally advanced and metastatic disease*

- A small proportion of patients with locally advanced disease due to vascular invasion may be suitable for resection. There is some evidence that preoperative chemotherapy may increase resectability in this cohort.
- The mainstay of treatment is symptom control. For patients with jaundice, stenting is the currently favoured modality, with the insertion of a metallic stent at ERCP or PTC if ERCP fails to gain access to the bile duct. Interest in surgical bypass has rekindled in recent years, with the use of minimally invasive surgical techniques.
- For patients developing gastric outlet obstruction, duodenal stenting may be attempted or patients may be suitable for a surgical bypass.
- For those deemed fit enough to tolerate chemotherapy, combined modality treatment with chemo-radiotherapy is commonly used.
- Most clinical trials are small and non-randomized.
- Two randomized studies have consistently shown that fluorouracil-based chemo-radiation has a survival advantage, compared to radiotherapy alone.
- The limited available data suggest a benefit for combined-modality treatment, compared with chemotherapy alone, although this benefit is small.
- Capecitabine may be preferable to a gemcitabine-based regimen as consolidation chemo-radiation, following induction chemotherapy.

- However, many patients with advanced disease are not fit for palliative chemotherapy, and so the mainstay of their treatment is pain control and nutritional support.
- The median survival of these individuals is 6–11mo.
- Until recently, gemcitabine monotherapy was the standard of care for the palliation of patients with advanced disease.
- The objective response rate with gemcitabine monotherapy is disappointing ( $\leq 10\%$ ). However, gemcitabine has a superior clinical benefit response (24%), compared to fluorouracil (4%), and a modest, but significant, improvement in the median OS (5.65mo versus 4.41mo) and in 1y survival (18% versus 2%), compared with fluorouracil.
- The addition of erlotinib, an EGFR TKI, to gemcitabine resulted in a statistically significant improvement in OS, compared with gemcitabine in combination with a placebo.
- Combination chemotherapy with the 'FOLFIRINOX' regimen (fluorouracil, FA, oxaliplatin, and irinotecan) results in an improved objective response rate (31.6% versus 9.4%), median PFS (6.4mo versus 3.3mo), and median OS (11.1mo versus 6.8mo), compared with gemcitabine monotherapy, in patients with an adequate performance status.
- More recently, gemcitabine, in combination with *nab*-paclitaxel, has resulted in superior objective response rates (23% versus 7%), median PFS (5.5mo versus 3.3mo), and median OS (8.5mo versus 6.7mo), compared with gemcitabine monotherapy.
- The median survival of these individuals is 2–6mo.

## Pancreatic: pancreatic neuroendocrine tumours

### Incidence

- Incidence of 1 per 100 000 population.
- Equal gender distribution.
- Peak incidence 30–60y.
- Represent 2% of pancreatic carcinomas.

### Aetiology

- The vast majority of carcinomas arising from the endocrine pancreas are sporadic.
- No specific risk factors have been identified.
- 1–2% of endocrine tumours are associated with autosomal dominant conditions:
  - MEN type 1—80% have a pancreatic endocrine tumour; most are small; gastrinoma > insulinoma; 10% are symptomatic; defect of menin gene on 11q13)
  - von Hippel Lindau (vHL)—15% have a tumour, and almost all are non-functioning
  - neurofibromatosis type 1—seen in 10% and usually somatostatinomas, but do not cause a syndrome
  - tuberous sclerosis—very rare.

### Pathology and presentation

- 70% are functional, producing gut hormones, and the remainder are said to be 'non-functioning'.
- Functional tumours are usually suspected, based on symptoms generated through hormone production, and confirmed on measurement of a gut hormone profile.
- Non-functional tumours have a similar presentation to ductal adenocarcinomas and are usually larger.

#### *Insulinoma*

- Commonest, with an incidence of 1–4/million population.
- Commoner in ♀ (3:2), with an average age of 50 at presentation, but, in MEN type 1 patients, the mean age is mid 20s.
- Only 10% are malignant.
- Usually single, small, sporadic, and intra-pancreatic.
- 10% associated with familial syndromes, and these may be multicentric; 4% of MEN type 1 have an insulinoma.
- Causes hypoglycaemia with symptoms, including headaches, confusion, palpitations, anxiety, visual disturbances, weakness, and seizures.
- Diagnosis based on fasting hypoglycaemia in the presence of elevated insulin. A 72h fast may also be used if the initial assessment is equivocal. Proinsulin and C-peptide levels are also high.
- Often difficult to locate on cross-sectional imaging and may require additional studies such as pre-operative venous sampling, somatostatin scintigraphy, or intra-operative ultrasound.
- Evenly distributed through the pancreas.



- High resectability rate, even with metastatic disease, where debulking can be performed, as they are usually slow-growing.

### *Gastrinoma*

- Incidence of 0.5–3/million population.
- ♂ dominance of 2:1, with a mean age at presentation of 30–50y.
- 90% are malignant or have malignant potential.
- Mainly sporadic. Pancreatic lesions are single and large, with a mean size of 4cm. Only 20% are intra-pancreatic, and the majority (70%) are duodenal which are often smaller and multiple.
- 25% have a genetic link to MEN type 1, but almost all of these are duodenal.
- Patients usually have multiple ulcers in the stomach, oesophagus, and small bowel (Zollinger–Ellison syndrome), with modes of presentation including pain, bleeding, and perforation. Diarrhoea and steatorrhoea are also reported.
- Diagnosis is based on an elevated serum gastrin level, in association with increased basal acid production. Must be off a proton pump inhibitor (PPI) for at least 1wk, and placed on an H<sub>2</sub> inhibitor instead. Gastric pH should also be measured.
- Lesions are usually localized with cross-sectional imaging.
- Evenly distributed throughout the pancreas.
- Resectability rates are increasing, as now being diagnosed earlier due to greater awareness. Debulking is also an option for gastrinomas.

### *Glucagonoma*

- Rare—<300 cases in the literature.
- Equal gender distribution. Average age of 50 at presentation.
- The majority are malignant, with 60% having liver metastases at presentation.
- 90% sporadic. Usually single and large, with a mean size of 6cm.
- 10% linked to MEN type 1.
- The classic presentation is with necrolytic migratory erythema. Other features include diabetes, stomatitis, anaemia, and weight loss.
- Diagnosed on the basis of elevated glucagon and findings on cross-sectional imaging.
- Lesions are usually localized with cross-sectional imaging.
- 80% are located in the body and tail.
- Resectability rate is high, and debulking is often possible for metastatic disease.

### *VIPoma*

- 0.05–0.5/million population.
- Equal gender distribution. Most present during the fifth decade of life.
- 60–80% show malignant behaviour.
- Usually sporadic, with a mean size of 3cm at presentation.
- 5% associated with MEN type 1.
- The classic presentation is with profuse watery diarrhoea of up to 5L/day. Associated hypokalaemia, weakness, lethargy, nausea, and vomiting. Also known as Verner–Morrison syndrome or watery diarrhoea and hypokalaemia achlorhydria (WDHA) syndrome.
- Diagnosis is based on an elevated serum vasoactive intestinal peptide (VIP) in a patient with large-volume secretory diarrhoea.

- Lesions are usually localized with cross-sectional imaging.
- Mainly located in the body and tail of the pancreas.
- Resectability rate is high, and debulking is often possible for metastatic disease.

#### *Somatostatinoma*

- 0.025/million population.
- Equal gender distribution. Most present during the fifth decade of life.
- 50–60% are malignant.
- Usually sporadic, with a mean size of 5cm, and 50% are pancreatic, with the remainder in the duodenum or small bowel.
- 7% associated with MEN type 1.
- Non-specific symptoms—steatorrhoea, weight loss, hypochlorhydria, diarrhoea, diabetes mellitus, cholelithiasis, and anaemia.
- Diagnosis is based on the identification of an elevated serum somatostatin.
- Lesions are usually localized with cross-sectional imaging.
- Mainly located in the body and tail of the pancreas.
- Resectability rate is high, and debulking is often possible for metastatic disease.
- Other very rare functional endocrine tumours produce growth hormone-releasing hormone and ACTH.
- Non-functional neuroendocrine tumours are usually >5cm and are more advanced at presentation, when compared to functioning tumours, with the majority having liver metastases; 50% are malignant. Symptoms are typically pain, weight loss, and jaundice. The incidence is increasing as a result of being incidental findings on cross-sectional imaging. They may produce chromogranin A (70–100%) or pancreatic polypeptide (50–100%). Resection rates are lower, and debulking metastatic disease does not improve outcome.

#### **Diagnosis**

- The diagnostic and staging process is similar to that of a ductal adenocarcinoma, with cross-sectional imaging using CT and MRI being the commonest modalities. They are usually hypervascular, giving characteristic appearances. These modalities detect >70% of lesions of >3cm, but <50% of those of <3cm—usually insulinomas.
- Somatostatin receptor scintigraphy, using radiolabelled octreotide, is of use in localizing pancreatic endocrine tumours, as most express somatostatin receptors. This is useful to detect 1° lesions and metastatic disease and changes management in around 40% of cases. Not useful for insulinomas, as 90% do not express the receptor.
- EUS is useful to help identify small lesions, in particular insulinomas, as these are often octreotide-avid.
- PET scanning is increasingly being used and appears to be a sensitive means of localizing tumours.
- Intraoperative localization with ultrasound is of great value for small lesions.
- Assessment of venous gradients is now rarely performed.
- Functioning endocrine tumours also produce chromogranin A in 60–90% of cases, and insulinomas express chromogranin B.

## Staging

- The WHO staging, as described in the section on neuroendocrine tumours of small intestinal cancers → Neuroendocrine, p. 334, is used to classify pancreatic lesions.
- The staging of pancreatic endocrine tumours is according to the TNM classification, as per ductal adenocarcinomas.

## Treatment

### *Potentially curable disease*

- Important medical treatments include PPIs for gastrinomas and the use of somatostatin analogues which are beneficial for most functioning tumours.
- Surgical treatment options are similar to those of ductal adenocarcinomas.
- A proportion of small carcinomas are suitable for pancreas-sparing surgery such as enucleation or central pancreatectomy.
- For patients with metastatic disease in the liver, transplantation and resection may be therapeutic options. Advanced disease may also be treated with hepatic artery embolization or chemoembolization and RFA.
- The 5y survival for pancreatic endocrine tumours is dependent on the functionality, specific hormone production, and stage at presentation.

For insulinomas, as malignant disease is uncommon, the 5y survival is >90%. For gastrinomas, patients with no metastases have a similar survival (90%), whilst 20–30% of patients with liver metastases survive 5y. For glucagonomas, VIPomas, and somatostatinomas, the survival of non-metastatic lesions is >95%, and 60% for those developing liver metastases. Non-functioning tumours have a 50% 5y survival rate.

## Ampullary carcinoma

Describes tumours arising in the distal 1–2cm or so of the bile duct where it passes through the duodenal wall, as well as the ampullary papilla itself and the intra-duodenal pancreatic duct.

### Incidence

- Traditionally thought to be rare, accounting for around 7% of periampullary lesions, but new cutting and staining techniques suggest it probably accounts for a third of cases, with similar numbers to pancreatic carcinoma and distal cholangiocarcinoma.
- US data from the National Cancer Institute's (NCI) Surveillance Epidemiology, and End Results (SEER) Program suggested an increasing incidence, although others have cast doubt on this and suggest it may be due to increased recognition on cross-sectional imaging.
- More common in men.
- Peak incidence from 60–70y.

### Aetiology

- The majority of ampullary carcinomas are sporadic.
- 200–300-fold increased risk for patients with FAP and HNPCC.

### Pathology

- Tumours of the ampulla of Vater may arise in the ampulla (intra-ampullary type) or on the duodenal surface of the papilla (periampullary type) or may involve both the intra-ampullary and periampullary regions (mixed type). Thus, ampullary tumours may show biliary and/or intestinal features.
- The origin of the tumour may be difficult, and occasionally impossible, to determine; the differential diagnosis includes carcinoma of the distal common bile duct, main pancreatic duct, and duodenum.
- New sectioning techniques, developed by Verbeke and colleagues, allow a more accurate definition of the tumour origin. Can distinguish on the basis of mucin subtypes, with ampullary carcinomas typically producing sialomucins.
- Important to differentiate on the basis of the mucosa of the ampulla (pancreatic, intestinal, or mixed), as tumours arising in the different subtypes of the mucosa have different outcomes. This is also important in relation to the selection of adjuvant/neoadjuvant therapies.
- Tumour morphology may be papillary or ulcerated. Lesions with a papillary morphology have a better prognosis, as they cause obstruction at an earlier stage.

### Presentation

- As both ampullary and pancreatic carcinomas occlude the pancreatic and common bile ducts, the presentation is, in most cases, identical to that of pancreatic cancer.
- In a small number of patients with polypoid lesions, there may be intermittent jaundice, as these tumours occlude the lumen, but then, as the pressure within the bile duct increases, they are displaced, restoring biliary flow.

## Diagnosis

- As with pancreatic carcinoma, ultrasound is often the first modality requested, in the presence of jaundice, and confirms biliary obstruction and identifies liver metastases, if present. However, ampullary tumours are rarely identified on ultrasound, as, given the location of the ampulla, tumours often obstruct the biliary tree when only small.
- Cross-sectional imaging, using CT and MRI, are the main modalities used for diagnosis and staging. A recent study has suggested that diffusion-weighted MRI provides greater diagnostic accuracy over conventional MRI.
- EUS is useful in confirming the size and depth of invasion of the tumour, so as to allow planning of therapy. For larger lesions, it identifies the relationships between the tumour and major vessels.
- ERCP may be of use in ampullary lesions to view the tumour and obtain biopsies. As with pancreatic cancer, for patients not suitable for resection, a stent may be placed, following discussion at an HPB MDT meeting.
- As with pancreatic cancer, laparoscopy is used variably. Ampullary carcinomas less typically disseminate to the peritoneum.
- PET-CT is often performed for periampullary carcinomas, although there is no specific study assessing its role in ampullary cancer.
- Ca19.9 levels are frequently measured in the work-up of patients with jaundice. Levels are often elevated in patients with ampullary carcinomas, but usually less so than for pancreatic cancer.

## Staging

- Staging of ampullary carcinoma is according to the TNM classification (see <https://cancerstaging.org> to download the TNM staging).

## Treatment

### Potentially curable tumours

#### *Surgical resection*

- Surgical resection is the main treatment option, with a pancreatoduodenectomy performed for resectable ampullary carcinomas, with morbidity and mortality similar to those for pancreatic carcinoma.
- The 5y survival for ampullary carcinomas is in the order of 60%, and in the order of 70–80% for node-negative disease.

#### *Locally advanced and metastatic disease*

- As with pancreatic carcinoma, options for the palliation of jaundice include surgical bypass or stenting of the biliary tree.

### Further reading

- Albores-Saavedra J, Schwartz AM, Batich K, Henson DE (2009). Cancers of the ampulla of Vater: demographics, morphology, and survival based on 5,625 cases from the SEER program. *J Surg Oncol* **100**, 598–605.
- Aune D, Greenwood DC, Chan DS, et al. (2012). Body mass index, abdominal fatness and pancreatic cancer risk: a systematic review and non-linear dose-response meta-analysis of prospective studies. *Ann Oncol* **23**, 843–52.
- Bassi C, Dervenis C, Butturini G, et al.; International Study Group on Pancreatic Fistula Definition. (2005). Postoperative pancreatic fistula: an international study group (ISGPF) definition. *Surgery* **138**, 8–13.
- Berger AC, Howard TJ, Kennedy EP, et al. (2009). Does type of pancreaticojejunostomy after pancreaticoduodenectomy decrease rate of pancreatic fistula? A randomized, prospective, dual-institution trial. *J Am Coll Surg* **208**, 738–47.
- Burris HA 3rd, Moore MJ, Andersen J, et al. (1997). Improvements in survival and clinical benefit with gemcitabine as first-line therapy for patients with advanced pancreas cancer: a randomized trial. *J Clin Oncol* **15**, 2403–13.
- Cancer Research UK (2013). Pancreatic cancer statistics. Available at: <http://www.cancerresearchuk.org/cancer-info/cancerstats/types/pancreas/>.
- Carter JT, Grenert JP, Rubenstein L, Stewart L, Way LW (2008). Tumors of the ampulla of vater: histopathologic classification and predictors of survival. *J Am Coll Surg* **207**, 210–18.
- Conroy T, Desseigne F, Ychou M (2011). FOLFIRINOX versus gemcitabine for metastatic pancreatic cancer. *N Engl J Med* **364**, 1817–25.
- Diener MK, Fitzmaurice C, Schwarzer G, et al. (2011). Pylorus-preserving pancreaticoduodenectomy (pp Whipple) versus pancreaticoduodenectomy (classic Whipple) for surgical treatment of periampullary and pancreatic carcinoma. *Cochrane Database Syst Rev* **11**, CD006053.
- Duell EJ, Lucenteforte E, Olson SH, et al. (2012). Pancreatitis and pancreatic cancer risk: a pooled analysis in the International Pancreatic Cancer Case-Control Consortium (PanC4). *Ann Oncol* **23**, 2964–70.
- Eshuis WJ, van Eijck CH, Gerhards MF, et al. (2013). Antecolic versus retrocolic route of the gastroenteric anastomosis after pancreatoduodenectomy: a randomized controlled trial. *Ann Surg* **259**, 45–51.
- Ito K, Fujita N, Noda Y (2011). Endoscopic diagnosis and treatment of ampullary neoplasm. *Dig Endosc* **23**, 113–17.
- Jacobs EJ, Chanock SJ, Fuchs CS, et al. (2010). Family history of cancer and risk of pancreatic cancer: a pooled analysis from the Pancreatic Cancer Cohort Consortium (PanScan). *Int J Cancer* **127**, 1421–8.
- Jang KM, Kim SH, Lee SJ, et al. (2013). Added value of diffusion-weighted MR imaging in the diagnosis of ampullary carcinoma. *Radiology* **266**, 491–501.
- Koti RS, Gurusamy KS, Fusai G, Davidson BR (2010). Meta-analysis of randomized controlled trials on the effectiveness of somatostatin analogues for pancreatic surgery: a Cochrane review. *HPB (Oxford)* **12**, 155–65.
- Larsson SC, Wolk A (2012). Red and processed meat consumption and risk of pancreatic cancer: meta-analysis of prospective studies. *Br J Cancer* **106**, 603–7.
- Michalski CW, Kleeff J, Wente MN, et al. (2007). Systematic review and meta-analysis of standard and extended lymphadenectomy in pancreaticoduodenectomy for pancreatic cancer. *Br J Surg* **94**, 265–73.
- Moore MJ, Goldstein D, Hamm J, et al. (2007). Erlotinib plus gemcitabine compared with gemcitabine alone in patients with advanced pancreatic cancer: a phase III trial of the National Cancer Institute of Canada Clinical Trials Group. *J Clin Oncol* **25**, 1960–6.
- Mukherjee S, Hurt CN, Bridgewater J, et al. (2013). Gemcitabine-based or capecitabine-based chemoradiotherapy for locally advanced pancreatic cancer (SCALOP): a multicentre, randomised, phase 2 trial. *Lancet Oncol* **14**, 317–26.
- Neoptolemos JP, Stocken DD, Friess H, et al. (2004). A randomized trial of chemoradiotherapy and chemotherapy after resection of pancreatic cancer. *N Engl J Med* **350**, 1200–10.
- Neoptolemos JP, Stocken DD, Bassi C, et al. (2010). Adjuvant chemotherapy with fluorouracil plus folinic acid versus gemcitabine following pancreatic cancer resection. *JAMA* **304**, 1073–81.
- Pancreatic Section of the British Society of Gastroenterology, Pancreatic Society of Great Britain and Ireland, Association of Upper Gastrointestinal Surgeons of Great Britain and Ireland, Royal College of Pathologists, Special Interest Group for Gastro-Intestinal Radiology (2005). Guidelines

- for the management of patients with pancreatic cancer periampullary and ampullary carcinomas. *Gut* **54** (Suppl 5), v1–16.
- Parkin DM (2011). Tobacco-attributable cancer burden in the UK in 2010. *Br J Cancer* **105** (S2), S6–S13.
- Pessaux P, Sauvanet A, Mariette C, et al. (2011). External pancreatic duct stent decreases pancreatic fistula rate after pancreaticoduodenectomy: prospective multicenter randomized trial. *Ann Surg* **253**, 879–85.
- Ramage JK, Ahmed A, Ardill J, et al. (2012). Guidelines for the management of gastroenteropancreatic neuroendocrine (including carcinoid) tumours (NETs). *Gut* **61**, 6–32.
- Rebours V, Boutron-Ruault MC, Schnee M, et al. (2008). Risk of pancreatic adenocarcinoma in patients with hereditary pancreatitis: a national exhaustive series. *Am J Gastroenterol* **103**, 111–19.
- Royal College of Pathologists (2002). *Standards and minimum datasets for reporting cancers. minimum dataset for the histopathological reporting of pancreatic, ampulla of Vater and bile duct carcinoma*. London: Royal College of Pathologists.
- Topal B, Fieuws S, Aerts R, et al. (2013). Pancreaticojejunostomy versus pancreaticogastrostomy reconstruction after pancreaticoduodenectomy for pancreatic or periampullary tumours: a multi-centre randomised trial. *Lancet Oncol* **14**, 655–62.
- Verberke CS, Leitch D, Menon KV, et al. (2006). Redefining the R1 resection in pancreatic cancer. *Br J Surg* **93**, 1232–7.
- Von Hoff DD, Ervin TJ, Arena FP, et al. (2013). Randomised phase III study of weekly nab-paclitaxel plus gemcitabine versus gemcitabine alone in patients with metastatic adenocarcinoma of the pancreas (MPACT). *J Clin Oncol* **30** (Suppl 34), abstract LBA148.
- Wente MN, Bassi C, Dervenis C, et al. (2007). Delayed gastric emptying (DGE) after pancreatic surgery: a suggested definition by the International Study Group of Pancreatic Surgery (ISGPS). *Surgery* **142**, 761–8.
- Wente MN, Veit JA, Bassi C, et al. (2007). Postpancreatectomy hemorrhage (PPH): an International Study Group of Pancreatic Surgery (ISGPS) definition. *Surgery* **142**, 20–5.
- Winter JM, Cameron JL, Olino K, et al. (2009). Clinicopathologic analysis of ampullary neoplasms in 450 patients: implications for surgical strategy and long-term prognosis. *J Gastrointest Surg* **14**, 379–87.
- Xiong JJ, Altaf K, Mukherjee R, et al. (2012). Systematic review and meta-analysis of outcomes after intraoperative pancreatic duct stent placement during pancreaticoduodenectomy. *Br J Surg* **99**, 1050–61.

## Gall bladder

### Epidemiology

- Represents 0.2% of cancers, with 500 new cases per year in the UK, this being one of the lowest international rates.
- Fifth commonest GI cancer worldwide and the commonest tumour of the biliary tract.
- Globally, the incidence has dropped, possibly due to increasing rates of cholecystectomy or screening programmes in high-risk populations.
- Incidental finding in one per 100 cholecystectomies, representing 30–40% of all gall bladder cancers, and these are usually of early stage.
- The incidence increases with age, with a peak incidence in the seventh decade.
- The ♂:♀ ratio is 1:3.
- High incidence in Northern India, Chile, and Eastern Europe. Gall bladder cancer is the most common cancer in women in Chile. In the US, rates are highest amongst Hispanic and Native American populations.

### Aetiology

- Related to gallstone disease, as at least 80% have cholesterol stones which are usually large and long-standing. Gallstones are associated with a 5-fold risk overall, this being 10-fold greater for larger stones than for smaller stones. Overall, the risk of malignant transformation over a 20y period for patients with gallstones is 1%.
- Bacterial infection is seen in 80%, and its role is related to stasis and chronic inflammation, leading to carcinogenesis. *Salmonella typhi* and *paratyphi* are the main organisms isolated from patients with carcinomas.
- Adenomas occur in the gall bladder, but the adenoma–carcinoma sequence is not fully understood. Malignant polyps are typically seen in patients aged >50y, and are single and >1cm in diameter.
- Porcelain gall bladder is a pre-malignant condition, with up to 15% developing a carcinoma.
- 1° sclerosing cholangitis (PSC) is associated with an increased risk of gall bladder carcinoma and gall bladder polyps.
- Even in the absence of PSC, ulcerative colitis is associated with gall bladder carcinoma.
- ♀ hormone exposure is linked to gall bladder carcinoma, with case control studies indicating women with long oestrogen exposure are at highest risk.
- A number of chemicals have been implicated, including rubber, vinyl chloride, and organopesticides. Gall bladder carcinomas are also linked to heavy metals (cadmium, chromium, lead) and radon exposure.
- The presence of a choledochal cyst or an anomalous pancreatobiliary junction is also linked to a higher rate of gall bladder, as well as biliary, cancers.
- Obesity increases the risk by up to 66%.
- Genetic links may exist, as gall bladder cancers are seen with an increased incidence in Gardner syndrome, neurofibromatosis type 1, and HNPCC.



## Pathology

- Most tumours arise in the fundus of the gall bladder.
- The majority are adenocarcinomas (85%), with histological subtypes including papillary, tubular, and mucinous or signet cell.
- Carcinomas are also described according to their morphology and may appear on imaging as a mass lesion (40–65%), wall thickening (20–30%), or a polypoid lesion (15–25%).
- Papillary tumours have a lower incidence of lymph node metastases and are associated with less local invasion and so have a better prognosis.
- Modes of metastasis include lymphatic, venous, direct invasion, and transperitoneal spread, with peritoneal and liver capsule implants seen in 20% at presentation.
- At presentation, only 25% have tumours limited to the gall bladder; 35% have loco-regional disease, and 40% have metastatic disease.
- Other histopathological subtypes (15%) include squamous, anaplastic, sarcoma, adenosquamous, small-cell carcinoma, neuroendocrine, lymphoma, and melanoma.

## Presentation

- Asymptomatic tumours are seen on the background of symptomatic gallstone disease, and so right upper quadrant pain, nausea, and vomiting are the common presentation.
- More advanced tumours present with pain, weight loss, and abdominal distension. On examination, jaundice, abdominal mass, weight loss, and ascites may be seen.

## Investigation

- USS is the standard first-line investigation, with a sensitivity for gall bladder cancer of 50–75%.
- Cross-sectional imaging with CT or MRI is used to assess loco-regional disease, including hepatic invasion and lymph node metastases, as well as distant metastases to the chest.
- Gall bladder cancer is PET-avid, and so PET-CT is a good means of assessing distant metastases, lymphadenopathy, and residual disease in the gall bladder bed, and so it is particularly useful in staging incidentally discovered carcinomas prior to radical surgery.
- EUS may be useful in evaluating the gall bladder in selected cases where the diagnosis on cross-sectional imaging is unclear. It also allows the assessment of the lymph node status and allows biopsy of the tumour/nodes to be performed.
- Laparoscopy is useful for patients with known gall bladder cancer to exclude peritoneal metastases prior to resection.
- Ca19.9 is elevated in patients with gall bladder cancer, but the test is not sensitive for gall bladder cancer, as levels of Ca19.9 are also increased in cholelithiasis, xanthogranulomatous cholecystitis, and jaundice which are associated with the carcinoma.

## Staging

- Staging of gall bladder carcinomas is according to the TNM classification (see <https://cancerstaging.org> to download the TNM staging).

## Treatment

### Potentially curable disease

- If an unsuspected gall bladder carcinoma is found on histological assessment after cholecystectomy, management depends on the histopathological stage and radiological staging of the patient.
  - Tis/T1a—if the cystic duct margin is clear, then no further surgery is required, as the rate of positive lymphadenopathy is probably <1%. If the cystic duct margin is positive, bile duct excision and regional lymphadenectomy is indicated.
  - T1b—this is the watershed area for the management of gall bladder cancer. There is a paucity of RCTs on the subject, but data would suggest that 10–12% of patients with this stage of disease would die of relapsed disease. This makes the discussion of subsequent radical surgery important with the younger patients.
  - T2—a second radical surgical procedure should be performed, as residual tumour is present in 50–75% of cases, and positive lymph nodes identified in 15% and 50%, respectively. The precise nature of the surgery varies between HPB units, as there are no consensus guidelines, although evidence would suggest a more radical approach is beneficial. Surgery should include excision of hepatic segments 4b and 5, regional lymphadenectomy, and, if the cystic duct margin is positive, excision of the extra-hepatic bile ducts with biliary reconstruction. Port sites should also be excised, as metastases occur at these sites in around 20% of cases. Radical surgery confers a substantial survival benefit in this group of patients which can approach 80% at 5y, following radical surgery.
- For tumours detected during cholecystectomy, frozen sections should be sent, and, if positive, the operation should be converted to a radical cholecystectomy or closed and referred to a tertiary centre. Preoperative features raising the suspicion of a carcinoma include a mass lesion (40–65%), a polyp of size >10mm (15–25%), or asymmetric wall thickening (20–30%).
- For early tumours identified prior to cholecystectomy, an open radical cholecystectomy should be performed, as described for T2 lesions.
- Most T3 tumours are identified preoperatively but occasionally are incidental findings. A proportion of these lesions are suitable for resection and often require excision of adjacent organs, as there is evidence to suggest such a radical approach is worthwhile. Again, units with large experience favour a right hepatic trisectionectomy to obtain adequate margins. Occasionally, a pancreatoduodenectomy may be required in addition, the so-called hepatopancreatoduodenectomy.
- A very small proportion of patients with T4 tumours may be candidates for resection, along the lines described in ↻ Treatment, p. 360.
- OS rate of <5%, with a median survival of 6mo. The results are better for those amenable to surgery. For Tis/T1a disease, the survival rate is close to 100%, and for T1b/T2 70–100%. For T3 tumours, the 5y survival is in the order of 50% after radical surgery, and for T4 lesions <25%.

### Adjuvant and neoadjuvant therapy

- No established benefits for either, but clinical trials are ongoing.

### Locally advanced and metastatic disease

- For patients subjected to an exploratory laparotomy, based on preoperative imaging, and found to be irresectable, a hepaticojejunostomy may be possible.
- For advanced tumours presenting with jaundice, ERCP and PTC may be used to stent the bile duct and provide palliation.
- Palliative chemotherapy for advanced disease in fit patients comprises gemcitabine and cisplatin (the latter switched to oxaliplatin by some); in less fit patients, single-agent treatment options include fluorouracil/FA, capecitabine, or gemcitabine.

### Further reading

- Corvera CU, Blumgart LH, Akhurst T, et al. (2008). 18 F-fluorodeoxyglucose positron emission tomography influences management decisions in patients with biliary cancer. *J Am Coll Surg* **206**, 57–65.
- Diehl AK (1983). Gallstone size and the risk of gallbladder cancer. *JAMA* **250**, 2323–6.
- Foster JM, Hoshi H, Gibbs JF, et al. (2007). Gallbladder cancer: defining the indications for primary radical resection and radical re-resection. *Ann Surg Oncol* **14**, 833–40.
- Furlan A, Ferris JV, Hosseinzadeh K, Borhani AA (2008). Gallbladder carcinoma update: multimodality imaging evaluation, staging, and treatment options. *AJR Am J Roentgenol* **191**, 1440–7.
- Maker AV, Butte JM, Oxenberg J, et al. (2012). Is port site resection necessary in the surgical management of gallbladder cancer? *Ann Surg Oncol* **19**, 409–17.
- Rathanaswamy S, Misra S, Kumar V, et al. (2012). Incidentally detected gallbladder cancer—the controversies and an algorithmic approach to management. *Indian J Surg* **74**, 248–54.

## Biliary tract

### Epidemiology

- Cholangiocarcinomas may arise within the intrahepatic or extra-hepatic bile ducts. Extra-hepatic cholangiocarcinomas are further divided to those around the hilum of the liver (hilar) and those affecting the common bile duct (distal).
- 25–50% of tumours are intrahepatic, and 50–75% are extra-hepatic, of which 70% are hilar and 30% are distal.
- Intrahepatic cholangiocarcinomas are the second commonest hepatic 1°.
- Incidence of 1 per 100 000 in Western populations.
- Account for ~3% of all GI cancers worldwide.
- The ♂:♀ ratio is around 1.5:1.
- Typically seen in the seventh decade of life.
- Some data suggesting rates rising over the past decades for intrahepatic cholangiocarcinomas and falling for extra-hepatic tumours.
- There is a geographical variation in incidence, with high-risk areas including North East Thailand (100/100 000), Japan, Korea, Israel (7.3), and Eastern Europe. The rate of cholangiocarcinomas in Native Americans is 6-fold that of non-native populations.

### Aetiology

- 70% are sporadic.
- PSC is associated with a lifetime risk of 6–36%. PSC is the commonest risk factor in Western populations and is present in 10% of cholangiocarcinomas. Most develop within 1–2y of diagnosis of PSC and so are at a younger age; therefore, they need to be fully evaluated and followed.
- Parasitic infections with liver flukes (*Clonorchis sinensis* and *Opisthorchis viverrini*) in Asia are associated with a 5–28-fold risk. It is an attributable factor in 88% of cases of cholangiocarcinoma in endemic areas.
- Hepatolithiasis is associated with 20% of cholangiocarcinomas in Taiwan, but rare in the West. Often coexist with liver flukes, as these are seen in 30% of patients with hepatolithiasis. Two to 10% of patients with hepatolithiasis in high-risk areas develop intrahepatic cholangiocarcinoma.
- Choledochal cysts are associated with between a 10- and 50-fold risk, and an overall lifetime risk of 6–30%. Risk is greatest in Asian populations where the prevalence of cholangiocarcinoma is higher and the average age at presentation is 34y.
- A history of Thorotrast use is associated with a 300-fold risk.
- Malignant foci are identified in 40% of patients with biliary papillomatosis.
- Intrahepatic cholangiocarcinoma is associated with ulcerative colitis, but not Crohn's disease.
- Other possible risk factors include choledocholithiasis, cholangitis, chronic hepatitis B or C, cirrhosis, diet, obesity, smoking, alcohol consumption, industrial toxins (dioxin, nitrosamines, polyvinyl chloride), and aflatoxins.

## Pathology

- The commonest tumours are adenocarcinomas (95%). These are divided into sclerosing (75%), nodular (20%), and papillary (5%) subtypes, according to their morphology. The remaining 5% are mainly squamous tumours.
- Tumours are further classified according to growth patterns into mass-forming, periductal infiltrating, intraductal, and mixed types.
- Adenocarcinomas are believed to follow a sequence through hyperplasia to dysplasia and on to carcinoma as a result of chronic inflammation.
- Hilar cholangiocarcinomas were first regarded as a separate entity by Klatskin, and cancers in this region are referred to as Klatskin tumours.
- Metastases occur through lymphatic spread, direct invasion, and via the biliary tree. Fifty per cent of patients have lymph node metastases at presentation, and a further 20% have peritoneal or distant metastases.
- Given the extent of resections required for cholangiocarcinomas, histological confirmation is preferable prior to resection, although this may be difficult to obtain. Historically, 5% of tumours are benign, one of the commonest lesions being autoimmune cholangitis, and so serum measurement of, and tissue staining for, IgG4 are important.
- Resectability rates are highly variable and, in the best centres, are around 75%, with a negative margin rate of 75%. However, many centres report that only one-third of patients are resectable.

## Presentation

- Most patients present with painless jaundice (90%), and 66% note pruritus. The presence of pain, which is reported in 30–60% of cases, suggests the presence of advanced stage. Weight loss is another common symptom, seen in up to 50% of cases. ~20% of patients present with cholangitis.
- Clinical signs, apart from jaundice, are few in early-stage disease. In advanced tumours, an abdominal mass and/or ascites may be present.

## Investigation

- Ultrasound is the first-line investigation and is useful in confirming biliary dilatation and its level and in excluding gallstones as the cause of jaundice. USS may identify a tumour within the bile duct, and Doppler is useful for assessing the patency of vessels at the hilum and within the liver.
- CT scanning provides details of the size and location of the tumour, as well as an assessment of the presence of lymphadenopathy and distant metastases. Vascular reconstructions of the vessels provide detailed information on the likelihood of resection and may indicate the cause of liver atrophy, if this is present. Measurement of the FLR will determine the need for PVE ahead of liver resection.
- Magnetic resonance cholangiopancreatography (MRCP)/MRI are useful to determine the extent of invasion into the hepatic parenchyma, local lymph node involvement, and vascular involvement. It is often preferred over CT because of superior spatial resolution that allows better delineation of the biliary tree and the extent of tumour infiltration into the hepatic parenchyma. It is crucial that imaging is performed prior to stenting of the biliary tree.

- EUS allows an accurate assessment of the bile duct, in particular for distal lesions, and allows biopsy of the tumour or lymph nodes to be performed. PET-CT is beneficial in cholangiocarcinoma, as the tumour is FDG-avid.
- Percutaneous transhepatic biliary drainage (PTBD) is the preferred method for drainage of the biliary system, allowing the resolution of sepsis and the recovery of hepatic function. It is considered key in Eastern series where cholangiocarcinomas are commoner, and there is greater surgical experience with the condition. Multiple drainage catheters are inserted to ensure all liver segments are drained.
- Laparoscopy should be performed in all patients due to high rates of peritoneal spread. This is performed either as a staging operation or on the day of resection prior to laparotomy.
- Cholangioscopy, using the SpyGlass® system, is used by some centres to obtain adequate views of the tumour and tumour biopsies. Intraductal ultrasound is also in some centres to assess the depth of tumour invasion.
- Ca19.9 has a high specificity for distinguishing between benign and malignant hilar strictures. However, it is not so reliable in the presence of PSC.

### Staging

- The Bismuth–Corlette classification is commonly used for the classification of hilar tumours (see Table 17.5 and Fig. 17.5).
- The Blumgart classification (see Table 17.6) is also used for the classification of hilar cholangiocarcinomas and is used to predict the resectability of tumours.
- The TNM staging systems for intra- and extra-hepatic tumours vary, and there is further subdivision of the intrahepatic tumours, according to hilar or distal biliary location (see  <https://cancerstaging.org> to download the TNM staging).

**Table 17.5** Bismuth–Corlette classification of hilar cholangiocarcinomas

Type	Details
I	Involves the common hepatic duct, distal to the confluence
II	Involves the biliary confluence
IIIA	Involves the confluence and the right hepatic duct
IIIB	Involves the confluence and the left hepatic duct
IV	Multifocal, or tumour involving the confluence and both the right and left hepatic ducts

Adapted from Blechacz, Boris, Gores, Gregory. Cholangiocarcinoma, *Clin Liver Dis* 12 (2008) 131–150, with permission from Elsevier.

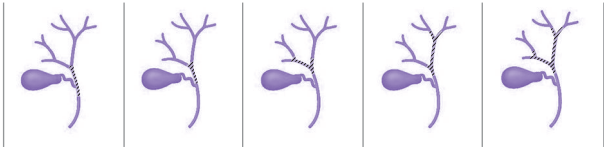

Fig. 17.5 Hilar cholangiocarcinomas.

Table 17.6 Blumgart classification of hilar cholangiocarcinoma

Type	Details
I	Tumour involves the biliary confluence with unilateral involvement up to the second-order biliary radicles. There is no portal vein involvement or liver atrophy
II	Tumour involves the biliary confluence with unilateral involvement up to the second-order biliary radicles. There is ipsilateral portal vein involvement or ipsilateral liver atrophy
III	Tumour involves the biliary confluence with bilateral involvement up to the second-order biliary radicles, or unilateral involvement up to 2° biliary radicles with contralateral portal vein involvement, or unilateral extension to 2° biliary radicles with contralateral liver atrophy, or main/bilateral portal vein involvement

Adapted from: Jarnagin WR, Fong Y, DeMatteo RP, et al. (2001) Staging, resectability, and outcome in 225 patients with hilar cholangiocarcinoma. *Ann Surg*; 234: 507–517, with permission from Lippincott Williams & Wilkins.

## Treatment

### Potentially curable disease

#### Surgical resection

- Surgical resection is the only potentially curative treatment. However, most patients (~80%) present with inoperable disease.
- *Intrahepatic cholangiocarcinomas*:
  - require a major or extended hepatectomy, with the extent of resection depending upon the anatomical location of the tumour.
- *Extra-hepatic cholangiocarcinomas*:
  - hilar tumours are treated by means of major hepatic resections, usually a right hemihepatectomy for Bismuth stages I, II, and IIIA, and a left hepatectomy for IIIB. A trisectionectomy is required for stage IV tumours. In all cases, a full lymphadenectomy of N1 nodes is performed, together with excision and reconstruction of the bile duct. It can be argued whether to excise the caudate for other right or left due to bilateral drainage—increases the 5y survival rates
  - distal tumours are treated by means of a pancreatoduodenectomy
  - small, early tumours arising in the middle portion of the duct may sometimes be amenable to hepaticojejunostomy without resection of the liver or pancreas

- a hepatopancreatoduodenectomy is sometimes indicated in fit young patients who have multifocal disease or in whom positive frozen section margins are identified
- it is important to perform frozen section analyses of the cut ends of the bile ducts, as tumours frequently spread submucosally
- mortality is <5% and morbidity around 50% in contemporary series of hilar cholangiocarcinomas. Fifty to 80% are infectious, including wound infection, cholangitis, intra-abdominal abscess, pneumonia, and hepatic abscess
- a protocol for liver transplantation, following neoadjuvant chemoradiotherapy, was developed by the Mayo clinic and has shown promise in highly selected populations, with other units currently adopting the protocol, but without replication of their excellent results
- the OS for cholangiocarcinoma is in the order of 6mo. For patients undergoing resection, the 5y survival for intrahepatic tumours is 20–60%, for hilar lesions 30–50%, and for distal cholangiocarcinomas 20–50%.

#### *Adjuvant and neoadjuvant therapy*

- No proven benefit from either.

#### *Locally advanced and metastatic disease*

- Biliary obstruction in patients with extra-hepatic cholangiocarcinomas may be relieved by surgical bypass in fit patients.
- Patients with obstructing intrahepatic cholangiocarcinomas and extra-hepatic lesions not amenable to surgical bypass should be palliated with metal stents. These may be inserted at either ERCP or PTC, depending on the location of the tumour, and, in many cases, a combined procedure may be required.
- Photodynamic therapy may also have a role in palliation, although further clinical trials are required.
- The combination of cisplatin and gemcitabine results in a significantly improved median OS (11.7mo), compared with gemcitabine alone (8.1mo), in patients with advanced disease, and it is the standard of care chemotherapy regimen.

#### **Further reading**

- European HPB Association (2008). Consensus conference on cholangiocarcinoma. *HPB* 2, 71–147.
- Khan SA, Davidson BR, Goldin RD, et al. (2012). Guidelines for the diagnosis and treatment of cholangiocarcinoma: an update. *Gut* 61, 1657–69.
- Nimura Y, Kamiya Y, Kondo S, et al. (2000). Aggressive preoperative management and extended surgery for hila cholangiocarcinoma: Magoya experience. *J Hepatobiliary Pancreat Surg* 7, 155–62.
- Rosen CB, Heimbach JK, Gores GJ (2012). Liver transplantation for cholangiocarcinoma. *Transplant Int* 23, 692–7.
- Tyson GL, El-Serag HB (2011). Risk factors for cholangiocarcinoma. *Hepatology* 54, 173–84.
- Valero V III, Cosgrove D, Herman JM, Pawlik TM (2012). Management of perihilar cholangiocarcinoma in the era of multimodal therapy. *Expert Rev Gastroenterol Hepatol* 6, 481–95.
- Valle J, Wasan H, Palmer DH, et al. (2010). Cisplatin plus gemcitabine versus gemcitabine for biliary tract cancer. *N Engl J Med* 362, 1273–81.



## Endocrine cancers

- Thyroid cancer 382
- Surgery for thyroid cancer 387
- <sup>131</sup>Iodine treatment for thyroid cancer 390
- External beam radiotherapy for thyroid cancer 392
- Targeted therapies for thyroid cancer 393
- Chemotherapy for thyroid cancer 394
- Surveillance, follow-up, and prognosis for thyroid cancer 395
- Adrenal cancer 396
- Neuroblastoma 400
- Further reading 402

## Thyroid cancer

### Epidemiology and aetiology

- The incidence of thyroid cancer has more than doubled over the last 30y. It accounts for ~1% of all malignancies in the UK, and 0.5% of all cancer deaths.
- In the UK, there are >2500 new cases/year (2010 data, Office for National Statistics).
- The ♀:♂ ratio is 3:1.
- The incidence peaks in the fourth decade, with a second peak at age >70y.
- Relatives of patients with thyroid cancer have a 10× ↑ risk.

### Differentiated (papillary, including follicular) carcinomas

- 70–75% of thyroid cancers are papillary carcinomas, i.e. differentiated epithelial tumours.
- The only well-established risk factor is previous head and neck irradiation, particularly in early childhood.
- ~5% have ≥1 affected first-degree relative.
- Few rare inherited syndromes, e.g.:
  - FAP
  - Gardner's syndrome.

### Anaplastic (undifferentiated) carcinomas

- ~5% of all thyroid cancers.
- Typically occurs in older patients than those with differentiated tumours; the mean age at presentation is 65y.
- ♀ > ♂.
- >1 in 5 will have a previous history or coexisting diagnosis of differentiated carcinoma.
- Up to 50% have a history of multinodular goitre.

### Medullary carcinoma

- 3–5% of all thyroid cancers.
- Typically in fifth to sixth decades of life.
- Slight ♀ preponderance only.
- 75% of cases are sporadic.
- 25% of cases are familial, tending to occur in younger age groups, i.e. third decade.
- If there is >1 case within the family, always consider the possibility of familial disease, e.g.:
  - MEN types 2a and b
  - isolated familial medullary thyroid cancer.

### Pathology and genetics

#### Differentiated (papillary, including follicular) carcinomas

- Typically unencapsulated ± cystic components.
- Papillae consisting of a few layers of tumour cells surrounding a fibrovascular core. Follicles and colloid are usually absent.
- ~50% contain calcified psammoma bodies—scarred remnants of tumour papillae.

- >50% of sporadic cases have somatic gene rearrangements, e.g.:
  - *RET* (rearranged during transfection) oncogene chimeric proteins (mutated fusion protein RET/PTC) with TK activity that contribute to the development of malignancy
  - oncogenic mutations in the serine kinase BRAF and the TK RAS.
- No germline mutations identified so far.

Several histological subtypes, most of which are rare. Examples include:

- follicular variant:
  - commonest subtype (~15%)
  - microscopically small to medium-sized follicles with near total absence of papillae
  - prone to haematogenous spread, but less likely to show lymphatic invasion.
- tall cell variant:
  - ~1% of papillary cancers
  - more aggressive than common-type papillary tumours—higher incidence of local invasion and distant metastases at presentation.

#### *Anaplastic (undifferentiated) carcinomas*

- Undifferentiated tumour of the thyroid follicular epithelium.

#### *Medullary*

- Unencapsulated neuroendocrine tumour arising from the parafollicular C-cells (the cell of origin of calcitonin).
- Variable histological appearances within a single tumour.
- 80% show amyloid deposition; 98% are calcitonin-positive.
- MEN type 2—autosomal, dominantly inherited syndromes arising from different mutations in the *RET* proto-oncogene.
  - MEN type 2a—100% get medullary thyroid cancer; ~50% develop pheochromocytomas, and ~30% get hyperplasia of the parathyroid glands
  - MEN type 2b—medullary carcinoma of the thyroid, which is often bilateral and more aggressive and occurs at an earlier age. Also marfanoid appearance, pheochromocytomas, but normal parathyroid hormone (PTH)
  - Familial medullary thyroid cancer—variant of MEN type 2a with similar high risk of medullary carcinoma, without the other associated diseases.
- 50% of sporadic cases have somatic *RET* gene mutations too.

#### *Other*

- 1° thyroid lymphoma.
- Metastases, e.g. from the breast or colon cancer.

## Screening and prevention

#### *Medullary carcinoma*

- Prophylactic thyroidectomy at an early age often appropriate, if known carrier of predisposing gene mutation. The assessment and surgery in these young patients are complex and should be carried out in tertiary referral centres.

- For example, in MEN type 2b, a total thyroidectomy (without a requirement for level VI central neck dissection) is recommended in the first year of life by both the British and American Thyroid Associations.
- Screening with serum calcitonin:
  - problematic
  - supranormal serum calcitonin response to IV calcium suggests C-cell hyperplasia or overt medullary carcinoma, but can get false positives, e.g. in autoimmune thyroid disease.
- Screening now usually by molecular analysis for germline *RET* gene mutations; ~7% of apparently 'sporadic' cases are also positive for germline mutations in the *RET* proto-oncogene, with significant implications for family members.

### Presentation

#### *Differentiated (papillary and follicular) carcinomas*

- Incidental microcarcinomas (<1cm) are a common finding at autopsy.
- The commonest clinical presentation is with a painless lump in the neck, i.e. a solitary thyroid nodule.
- Clinical regional lymph node involvement at diagnosis commoner in children (~50%) than in adults. However, occult nodal involvement in 40–90% of adults.
- 2–10% have disseminated disease at presentation, most commonly pulmonary or bony metastases.
- Most patients are clinically and biochemically euthyroid:
  - Graves's disease/toxic nodular goitre may coexist
  - carcinomas synthesizing functioning T<sub>3</sub>/T<sub>4</sub> (tri-iodothyronine/thyroxine) rare.

#### *Anaplastic (undifferentiated) carcinoma*

- Rapidly enlarging neck mass that may be painful.
- Confluent bilateral lymphadenopathy.
- 90% have regional or distant spread at diagnosis.
- The commonest sites of metastases are lungs and bones.
- ± SVCO and/or Horner's syndrome.

#### *Medullary carcinoma*

- Painless lump in the neck, i.e. a solitary thyroid nodule (>75%).
- Usually unilateral.
- 20% have locally advanced disease at presentation, e.g. symptoms of upper aerodigestive tract compression.
- ~50% have clinically detectable cervical lymph node involvement at diagnosis, and 15% have distant metastases.
- Large tumours may have an associated paraneoplastic syndrome, e.g. Cushing's syndrome due to corticotrophin secretion.

## Investigations

- Investigation of patients with suspected thyroid cancer, and their subsequent management, should be coordinated by a specialist MDT with expertise and interest in the management of thyroid cancer.
- The team will usually comprise a surgeon, endocrinologist, oncologist, pathologist, radiologist, medical physicist, biochemist, and a specialist nurse.
- Depending on the clinical situation, the following investigations may be considered:
  - FBC and LFTs
  - renal function—especially if considering radioiodine ( $^{131}\text{I}$ ) therapy
  - TFTs
  - calcitonin—produced by C-cells. Its role in the initial diagnostic evaluation of patients remains controversial due to the frequency of falsely high serum levels. Once a diagnosis of medullary carcinoma is confirmed, a baseline level will establish whether the tumour is capable of hypersecreting calcitonin, to assist with post-operative monitoring
  - high-resolution thyroid ultrasonography and FNA—the false negative rate varies from 0% to 5%, and the false positive rate is also usually <5%. NB FNA cannot distinguish a follicular adenoma from a follicular carcinoma; if the FNA report states ‘follicular lesion’, then at least a thyroid lobectomy is essential. FNA, in the hands of an experienced cytologist, can diagnose papillary, medullary, and anaplastic cancer.
  - A recent review of thyroid incidentalomas has suggested that, if the lesion is <10mm, without suspicious features, and the patient has no risk factors, the lesion should not undergo FNA. However, if the lesion is small (<10mm), but there is a bad family history, or if the lesion is >10mm, with suspicious features on ultrasound, or solid and larger than 15mm, all should have an FNA performed.
- If high risk of local disease extension (e.g. presentation with hoarseness, stridor, dysphagia, or haemoptysis), consider:
  - CT scan of the neck/mediastinum—assess for laryngeal involvement, invasion of the great vessels, etc.
  - MRI scan of the neck—evaluate any soft tissue invasion
  - CT of the chest/liver
  - skeletal scintigraphy—if there is any suspicion of bony disease. The typical appearances are lytic lesions.

## Staging

### *Differentiated (papillary) carcinomas*

The staging system for differentiated carcinoma of the thyroid is based on the ‘TNM system’:

- *T*— $1^{\circ}$  tumour. Generally reflects the size of the tumour invasion beyond the thyroid capsule (T4)
- *N*—involvement of regional lymph nodes
- *M*—absence (0) or presence (1) of distant metastases or inability to assess for their presence (X).

The AJCC staging system from 2002 is an example (see  <https://cancer-staging.org> to download the TNM staging).

**Anaplastic (undifferentiated) cancer**

These tumours have a very poor prognosis—all are effectively stage IV (see

➔ Further reading, p. 402).

**Medullary carcinoma**

The staging system is based on:

- the tumour size
- local invasion
- nodal disease
- metastases.

Unlike in differentiated thyroid cancer, age is not a factor in the staging of medullary thyroid cancer (see Table 18.1).

**Table 18.1** Staging system for medullary carcinoma of the thyroid

Stage I	1° tumour <1cm, with no evidence of disease outside the thyroid gland
Stage II	1° tumour >1cm or the presence of extrathyroidal invasion, without nodal or distant metastases
Stage III	Local or regional nodal metastases
Stage IV	Distant metastases

## Surgery for thyroid cancer

### Differentiated (papillary) carcinomas

*For the primary tumour (papillary, follicular)*

- Surgery is the 1° mode of treatment.
- The aim is to perform definitive surgery at the outset.
- At least, a total lobectomy must be performed on the side of the tumour, with identification of the recurrent laryngeal nerve. The prognosis, following incomplete surgery (e.g. removal of a suspicious nodule) and subsequent further surgery (e.g. completion thyroidectomy), may be less good than if a total thyroidectomy had been performed at the start. Furthermore, complications, such as recurrent laryngeal nerve palsy (1%), in first-time surgery are much higher in repeat resections.

Surgical options include the following.

#### *Unilateral total lobectomy*

May be appropriate for selected low-risk patients, e.g. pT1 (<1cm), N0 women aged <45y. Increasingly, these small tumours are being treated with lobectomy. Often, these very small tumours are being picked up incidentally on CT scans in patients being monitored for other tumours such as lymphoma.

#### *Total thyroidectomy*

- The procedure of choice in most cases.
- The current guidelines of the American Thyroid Association (2009) make specific recommendations as to the extent of thyroid surgery and any associated neck dissection in specific clinical scenarios.
- For instance, if the nodule is indeterminate but >4cm, total thyroidectomy is advised:
  - when there is marked atypia
  - when the FNA report features of papillary carcinoma
  - in patients with radiation exposure
  - and there are features of a family history of thyroid cancer.
- For patients with a thyroid cancer >1cm, a total thyroidectomy is recommended, unless otherwise contraindicated to this surgery.
- A total lobectomy is reserved for differentiated thyroid cancer <1cm, low risk, unifocal, and intrathyroid lesion, in the absence of head and neck radiation.
- Therapeutic lateral neck dissection is required for biopsy-proven metastatic lateral cervical nodes.
- Advantages include:
  - many papillary tumours are multicentric
  - up to one in five will recur after partial thyroidectomy
  - local recurrence is associated with a poor prognosis, with up to 40% risk of death from metastatic disease (others argue this can be treated with radioactive iodine)
  - small risk of progression to anaplastic carcinoma
  - subsequent monitoring for recurrence is easier (permits diagnostic/therapeutic <sup>131</sup>I scans)
  - up to 50% of completion thyroidectomies are tumour-positive
  - recent data on SLNB in thyroid cancer are showing some promise.

*More extensive resection*

- In pT4 tumours, the options are:
  - extensive resection of all involved structures, e.g. larynx, oesophagus, with potential loss of organ function, *or*
  - conservative surgery with preservation of local structures, but residual foci of disease, followed by EBRT.
- Rates of local control and DFS are similar, but the QoL appears better, following the more conservative surgery.

Long-term data (30y) from the Mayo Clinic show a 30y mortality of 2%, irrespective of the extent of surgery.

Those who argue for a total lobectomy (only) quote an increased risk of recurrent laryngeal nerve damage and hypocalcaemia after total thyroidectomy.

Frozen section is rarely used for the thyroid mass with good preoperative fine-needle cytology. However, there may be a role for intraoperative frozen section to investigate enlarged lymph nodes found at surgery.

*Potential complications of thyroid surgery*

- Hypoparathyroidism.
- Recurrent laryngeal nerve injury → hoarse voice and 'bovine' cough (should be <1% in experienced hands). In parts of Europe, in particular Germany, recurrent laryngeal nerve monitoring is being used in an effort to avoid nerve palsy.
- Superior laryngeal nerve injury → inability to reach higher registers with voice.
- Follow-up with thyroglobulin (TG) (serum) measurement is standard for differentiated thyroid cancers.
- Bleeding—ranges from 0 to 6.5%. In some centres, in carefully selected cases, thyroid surgery is performed as a day case. However, if the surgery is a total thyroidectomy, then 24h observation is recommended.

*Selective neck dissection*

The extent of neck dissection should be dependent on:

- the size of the 1° tumour, e.g. up to 80% of pT4 tumours will have regional nodal involvement at presentation
- the clinical examination, e.g. the presence of palpable nodes
- intraoperative findings, e.g. suspicious nodes at surgery ± histological examination of frozen section
- gross cervical metastatic disease should be treated with a modified radical neck dissection.

*Recurrent or metastatic disease*

- If there is metastatic disease at presentation, total thyroidectomy and ablation are usually still required, because optimal management is based on the ability of most differentiated cancers to concentrate <sup>131</sup>I.
- Re-excision can be considered for locally recurrent disease.
- Occasionally, resection may also be appropriate for a solitary metastatic deposit.
- Further surgery is usually followed by <sup>131</sup>I therapy ± EBRT.



### Anaplastic (undifferentiated) carcinomas

- Usually inoperable at presentation (50% have lung 2° at presentation).
- The American Thyroid Association guidelines (2009) suggest that, if the disease appears operable, especially the intrathyroid subtype, a total thyroidectomy and therapeutic node dissection should be attempted. Surgery offers the best chance of a prolonged period of symptom-free survival.
- Total thyroidectomy may not produce any survival advantage over ipsilateral thyroid lobectomy with wide margins of adjacent soft tissue. However, this is rarely possible.
- Most anaplastic tumours in the UK are advanced and not surgically resectable.
- Unless impending airway compromise, a tracheostomy or tracheal stent are best avoided.

### Medullary carcinoma

- Preoperative screening for pheochromocytoma (MEN type 2) and hyperparathyroidism with  $\uparrow$   $\text{Ca}^{2+}$  (MEN type 2a).
- All patients should be treated by *total* thyroidectomy, where possible, because:
  - surgery is the only potentially curative intervention
  - 20% have intra-glandular lymphatic spread
  - 20% are *RET* oncogene-positive, even if the case is apparently 'sporadic'
  - a hereditary background may not be known
  - radioactive iodine is not effective.
- The quality of lymph node dissection is paramount and appears to be the sole surgical factor that can improve prognosis. The size of the 1° correlates with the chances of metastatic lymphatic spread:
  - <1cm  $\rightarrow$  11–50%
  - >2cm  $\rightarrow$  60%
  - Palpable tumour  $\rightarrow$  85%.
- Usually surgery involves total thyroidectomy, and central and ipsilateral neck node dissection. Virtually all centres recommend prophylactic central node dissection (level VI), along with total thyroidectomy, by an experienced thyroid surgeon (American Thyroid Association guidelines, 2009). If lateral cervical node spread is identified, then lateral neck dissection (levels IIA, III, IV, V) should be performed, in addition.
- In medullary thyroid cancer, the involvement of central neck nodes is a strong pointer to the involvement of ipsilateral lateral neck nodes (77%).
- Surgery with palliative intent can also produce long-term survivors, e.g. re-operation for local recurrence or even resection of solitary metastases.
- Screening for disseminated disease, prior to further surgery, should include laparoscopy to assess for liver metastases. Up to 20% of patients with no hepatic disease identified on conventional imaging will have liver 2° seen at laparoscopy.
- All familial cases (frequently bilateral) must have total thyroidectomy.

There are a number of subgroups of well-differentiated thyroid cancer that are aggressive and require total thyroidectomy; these include the tall cell variant, columnar cell variant, insular carcinoma, and Hurthle cell carcinoma.

## <sup>131</sup>Iodine treatment for thyroid cancer

<sup>131</sup>I is used in the diagnosis and treatment of differentiated thyroid carcinoma for:

- the ablation of residual thyroid tissue in selected patients
- the assessment of possible disease recurrence
- the treatment of known distant (<sup>131</sup>I-avid) metastases or gross extension of the tumour beyond the thyroid.

<sup>131</sup>I ablation of remnant thyroid tissue is recommended for all patients whose tumour is >4cm. It is also recommended for selected patients with thyroid tumour <4cm, if certain high-risk features are present (see ➔ Further reading, p. 402).

Post-thyroidectomy, there are typically up to 2g of functioning thyroid remnant. <sup>131</sup>I is administered at doses sufficient to ablate residual thyroid tissue, including microscopic foci of malignancy. This:

- reduces the risk of local recurrence by ~60%, compared to thyroid suppression alone
- prolongs OS and DFS
- is effective against microscopic disease only; it is not a treatment for macroscopic residual cancer
- increases the sensitivity and specificity of the subsequent screening programme to identify persistent or recurrent disease.

Screening may be by:

- monitoring changes in serum TG levels (TG is secreted by normal and >90% of cancerous thyroid cells, so ablation of all active thyroid tissue should mean that TG is undetectable)
- diagnostic <sup>131</sup>I scans.

Preparation for treatment with <sup>131</sup>I requires:

- total thyroidectomy ~1mo previously
- TSH stimulation, i.e. carefully scheduled thyroid hormone replacement, a low-iodine diet (for 1–2wk), and no iodine-containing medication, to maximize the chance of avid uptake of the iodine (NB Beware the iodine load of CT contrast agents)
- the biochemical confirmation of hypothyroid status prior to administration (patient likely to be feeling unwell by this stage)
- explanation to the patient—they will be confined to a single room during their admission, interaction with nurses will be minimal, and visitors will be limited, etc.
- sperm storage (for men, particularly if repeated treatments look likely).

Post-ablation, diagnostic <sup>131</sup>I scans are performed to confirm the absence of residual active thyroid tissue. The serum TG level should become undetectable.

Potential acute toxicity of therapeutic <sup>131</sup>I treatment includes:

- nausea
- sialadenitis
- cystitis/gastritis
- haemorrhage into metastases (rare).

Late effects include:

- a persistent dry mouth
- accelerated dental caries
- small risk of second (late) malignancies, particularly if repeated cycles of treatment have been necessary, e.g. leukaemias, salivary gland tumours.

Replacement thyroid hormone therapy should be commenced, following the ablation of active glandular tissue. The aim is for lifelong suppression of TSH, i.e. the dose of exogenous hormone aims to maintain biochemical hyperthyroidism to avoid a theoretical overstimulation of occult residual tissue.

Diagnostic  $^{131}\text{I}$  scans can be repeated as part of post-treatment surveillance; >60% of differentiated thyroid cancers take up enough iodide to be detected by  $^{131}\text{I}$  imaging.

Treatment doses of  $^{131}\text{I}$  can be repeated if:

- serum TG begins to rise
- further activity is observed on a diagnostic  $^{131}\text{I}$  whole-body scan, indicating inoperable or metastatic disease, e.g. pulmonary metastases.

$^{131}\text{I}$  can be curative in a small minority of patients with metastatic disease.

There is no role for  $^{131}\text{I}$  treatment in medullary or anaplastic carcinoma—these tumours are not iodine-avid.

## External beam radiotherapy for thyroid cancer

### Differentiated (papillary and follicular) carcinoma

#### Following complete resection

- Adjuvant EBRT is not commonly used in this setting.
- It may be offered to selected patients whose tumours do not concentrate  $^{131}\text{I}$ .
- It should also be considered after surgery and  $^{131}\text{I}$  therapy if:
  - the 1° tumour is large (pT4)
  - there is extracapsular spread, with a high likelihood of microscopic residual disease
  - there are other poor prognostic features (see  Prognosis, p. 395).
- A typical treatment regime would involve 60Gy administered in 30 fractions. Treatment is usually in two phases, with lead shielding in the second phase to avoid exceeding the spinal cord tolerance.
- Conformal techniques, CT planning, and IMRT allow reduction in the dosage to normal tissue.
- Potential acute side effects include cutaneous erythema, desquamation, mucositis, and dysphagia. Late side effects include skin pigmentation and the formation of telangiectasia.

#### Palliation

- Role for EBRT:
  - after incomplete resection—to improve local control of residual tumour. One trial comparing the outcome in patients with incompletely resected disease treated with either surgery alone or post-operative radiotherapy found an increase in the 5y survival from 38% to 77%
  - for symptomatic metastatic lesions, e.g. painful skeletal 2°, when  $^{131}\text{I}$  is often less effective
  - for metastatic disease in critical locations.

### Anaplastic (undifferentiated) carcinoma

- Consider post-operative radiotherapy for the small number of patients whose tumours are completely resected.
- More frequently used with palliative intent for the local control of inoperable tumours or for symptomatic metastatic disease. Up to 80% will have a partial response for a short period of time.
- Stridor or SVCO are urgent indications for radiotherapy.

### Medullary carcinoma

- Post-operative EBRT for macroscopic remnant to maximize local control.
- Alternatively, preoperative radiotherapy may cause an inoperable tumour to become operable.
- Occasional avidity of uptake to MIBG makes radioiodinated MIBG therapy a possibly useful therapeutic modality.

## Targeted therapies for thyroid cancer

- A greater understanding of the molecular pathogenesis of some thyroid cancers, in particular the identification of oncogenic mutations (see Pathology and genetics, p. 382) has led to growing interest in targeted therapies.
- In the UK, use of these agents remains largely limited to within the context of clinical trials. Given the absence of efficacious chemotherapy regimes for progressive metastatic  $^{131}\text{I}$ -resistant differentiated thyroid carcinoma, entry into clinical trials should be encouraged, wherever possible.
- If trial entry is being considered, analysis of the tumour sample for common genetic mutations, e.g. *RET*, *BRAF*, *MEK*, etc. will often dictate which trial availability. Trials increasingly restrict entry, to include only patients whose tumours have proven mutations within specific genes.

### Small molecule kinase inhibitors

- Mutations in the serine kinase *BRAF* and the TKs *RAS* and *RET* appear to have a pathological role in a significant proportion of differentiated thyroid cancers.
- Inhibiting the products of these mutated genes and the associated receptor TK VEGF receptor (see Chapter 9) offers the prospect of targeted treatment for selected thyroid cancers.
- Many relapsed thyroid cancers are hypervascular and have high levels of VEGF expression.

Examples include:

- vandetanib:
  - an orally administered small molecule TKI (see Chapter 9), which inhibits VEGF receptor, EGFR, and RET
  - licensed for the treatment of patients with progressive, symptomatic medullary thyroid cancer, ideally after confirmation of a mutation in the *RET* gene
  - side effects include rash, photosensitivity, diarrhoea, nausea, and prolongation of the QT<sub>c</sub> interval
- sorafenib:
  - an orally administered multi-targeted small molecule TKI (see Chapter 9), which inhibits common RET/PTC subtypes, members of the *BRAF* kinase family, and PDGFRs and blocks the intracellular domain of the VEGF receptor
  - not currently licensed for the treatment of patients with thyroid cancer
  - promising phase II data in patients with metastatic differentiated thyroid cancer, with partial response rates of 15–40%, greater proportions achieving stable disease, and PFS of 14–18mo reported
- sunitinib:
  - an orally administered small molecule TKI (see Chapter 9), which inhibits multiple targets, including the VEGF receptor and two of the RET/PTC subtypes
  - not currently licensed for the treatment of patients with thyroid cancer
  - limited phase II data only, but modestly encouraging results.

## Chemotherapy for thyroid cancer

- Very limited role, particularly given the increasing interest in clinical trials of targeted therapies.
- Only if surgery,  $^{131}\text{I}$ , or EBRT no longer appropriate and the patient remains fit.
- Few prospective randomized trials.
- No role for adjuvant chemotherapy.
- Response rates in metastatic disease are poor (10–30%), incomplete, and of short duration.
- No evidence for improvement in OS.
- The standard first-line agent is doxorubicin.
- There are several trials supporting the use of dacarbazine combination chemotherapy in medullary thyroid cancer.

## Surveillance, follow-up, and prognosis for thyroid cancer

### Surveillance and follow-up

#### *Differentiated (papillary and follicular) carcinomas*

- Most recurrences occur within 5y.
- Regular physical examination, particularly of the neck.
- Serum T<sub>4</sub>, TSH, and TG at each visit. TG in the presence of a suppressed serum TSH requires investigation.
- ~5% of recurrent disease is not associated with ↑ TG.
- ± CXR, USS of the neck, and diagnostic <sup>131</sup>I imaging, depending on risk factors.

#### *Medullary carcinoma*

- Clinical examination.
- Serial serum calcitonin levels.
- Screen for familial disease—all new cases of medullary carcinoma of the thyroid should be offered genetics referral.

### Prognosis

#### *Papillary carcinoma*

- Most patients with papillary carcinoma do not die of their disease.
- 10y survival of >90%.
- The prognosis for the follicular subtype is less good than for that for common-type papillary carcinoma, e.g. 10y survival of 92% versus 98%.
- Stage IV disease still has a 5y survival of ~25%.
- Poor prognostic features include:
  - >45y old
  - larger 1° tumour, e.g. >7cm
  - bilateral or mediastinal lymph node involvement, or distant metastases
  - lymphocytic infiltration
  - ♂ sex
  - soft tissue or regional organ invasion, e.g. trachea, oesophagus, etc.
- The commonest site of initial relapse is local neck lymph nodes—treatment is usually further surgical resection, followed by <sup>131</sup>I therapy.

#### *Anaplastic (undifferentiated) carcinoma*

- Aggressive cancer with very poor prognosis.
- The median time from the first symptom to death is 3–7mo.
- 1y survival of 20–35%, and 5y survival of only 5–14%.

#### *Medullary carcinoma*

- No effective treatment in advanced disease. However, patients may live for years, despite a high metastatic load, e.g. the median survival for stages III/IV disease is 3–5y.
- Stage for stage, there seems to be no difference in prognosis between sporadic and hereditary disease. However, patients with MEN type 2b are more likely to have invasive disease at diagnosis, and hence fall into a worse prognostic group.

## Adrenal cancer

The adrenal gland is composed of:

- an outer cortex:
  - mainly controlled by the renin–angiotensin system that regulates the release of aldosterone
- an inner cortex:
  - mainly controlled by the corticotrophin-releasing hormone–corticotrophin (ACTH) system that regulates the release of cortisol and adrenal androgens
- a medulla:
  - which is part of the sympathetic nervous system.

Tumours arising in the cortex and medulla are aetiologically and functionally different, reflecting their cells of origin.

### Epidemiology and aetiology

#### Adrenocortical tumours

- Rare—incidence ~1.0 per 10<sup>6</sup> population.
- Account for only 0.2% of cancer deaths.
- Aetiology generally unknown—rare familial cases.
- Carcinomas even rarer—bimodal age distribution. Peak incidence before 5y of age and in the fourth to fifth decades.

#### Medullary tumours

- Even rarer—incidence ~0.6 per 10<sup>6</sup> population.
- ~10% currently identified as familial, although this is likely to increase with improvements in genetic analysis.
- Associated with MEN type 2 (germline mutation in *RET* proto-oncogene; see ↻ Medullary carcinoma, p. 389) and occasionally vHL disease.

### Pathology

#### Adrenocortical tumours

- Adenomas or adenocarcinomas of the adrenal cortex.
- If malignant, spread is via:
  - local invasion of lymph nodes and the liver
  - distant dissemination.
- 60% of all adrenocortical tumours are non-functioning.
- 40% are functioning, secreting steroids that may include oestrogens, testosterone, and/or aldosterone.

#### Medullary tumours

- The commonest adrenomedullary tumour is a pheochromocytoma—golden or tan-coloured appearance macroscopically.
- The majority are benign. Only ~10% are malignant.
- Tumoral hypersecretion of epinephrine, norepinephrine, and/or dopamine.
- 10% of pheochromocytomas are extra-adrenal, i.e. they arise elsewhere in the sympathetic chain; 10% are multiple.



- Hereditary pheochromocytomas:
  - often occur in younger age groups
  - more likely to be bilateral and benign.

## Presentation

### Adrenocortical tumours

(See Table 18.2.)

- Incidental finding. The current National Institutes of Health (NIH) position statement is that an incidentaloma <4cm (non-functioning) can be monitored. Above 6cm, they should be excised laparoscopically, because 30–80% will contain malignancy.
- ‘Pressure symptoms’, e.g. pain in the abdomen, symptoms from metastatic disease.
- In functioning tumours, symptoms and signs will vary, according to the predominant steroid hormone produced, e.g.:
  - virilization—the commonest presentation of adrenocortical carcinoma in children
  - Cushing’s syndrome—the commonest presentation of adrenocortical carcinoma in adults
  - feminization—very rarely
  - hypertension.

### Medullary tumours

- Incidental finding.
- During screening for associated familial syndromes.
- Intermittent, severe hypertension or essential hypertension.
- Classical presentation with episodic:
  - headache
  - sweating
  - tachycardia/palpitations
  - ± pallor or tremor.

**Table 18.2** Endocrine syndromes associated with adrenocortical tumours

Syndrome	Steroid
Cushing’s syndrome (ACTH-independent)	Cortisol
Conn’s syndrome/1° hyperaldosteronism	Aldosterone
Virilization syndrome	Androgen
Feminization syndrome	Oestrogen
Precocious puberty syndrome/adrenogenital syndrome	Sex hormones
Non-functioning	None

## Investigations

- Careful family history.
- Hb, electrolytes, urea, LFTs.
- Plasma catecholamines.

- Plasma aldosterone-to-renin activity ratio.
- Urinary vanillylmandelic acid (VMA) and urinary catecholamines.
- Chromogranin assays.
- Serum and urinary cortisols.
- Blood oestrogen and testosterone.
- CXR, USS, CT, MRI of the abdomen to assess for potential metastatic disease.
- USS of the thyroid gland (MEN).
- <sup>123</sup>I-MIBG, octreoscan—medullary tumour.
- Selenocholesterol imaging—cortical tumour.

### Surgery

- Surgery is the only treatment likely to achieve cure in benign disease or in the small group of patients with localized malignant disease without occult micrometastases.
- It may still be appropriate to resect the 1° tumour in the presence of metastases if it is slow-growing, or where there are a small number of metastases, in order to achieve local control.
- Radical resection (with adjacent nephrectomy, if necessary) is essential for cure.
- Special preoperative considerations:
  - correction of electrolyte abnormalities
  - appropriate specialist BP control.
- Surgery may be:
  - open—preferable for larger adenomas and carcinomas. Open surgery is still preferred for obvious carcinomas, although there are encouraging results for laparoscopic adrenalectomy with small cancers; some centres are performing laparoscopic resections for tumours over 6cm
  - laparoscopic—longer operating time, less post-operative pain, shorter hospital stay post-operatively. Long learning curve
  - As laparoscopic experience increases, a well-functioning MDT should discuss these complex tumours. A surgeon doing sufficient numbers per year and an experienced anaesthetist are mandatory
  - en bloc major resections of the tumour with adjacent organs are usually done with open surgery.

### Non-surgical options

#### *Adrenocortical tumours*

- Mitotane:
  - orally administered adrenocorticolytic drug, with some efficacy in patients with adrenal carcinoma
  - first-line treatment in unresectable/metastatic tumours
  - common side effects include nausea and anorexia. It may also cause cortisol and aldosterone deficiency, necessitating replacement therapy
  - control of the disease is usually transient, with symptomatic or biochemical progression typically occurring after only 6–12mo.
- Metyrapone, aminoglutethimide, and ketoconazole:
  - potential second-line medical therapies that can also reduce excessive cortisol secretion.

- Chemotherapy:
  - limited benefit
  - no randomized clinical trials
  - the most active drugs appear to be cisplatin and etoposide
  - patients should be referred for consideration of treatment within the context of randomized clinical trials, wherever possible
  - a recent phase II trial of bevacizumab, in combination with capecitabine, produced no evidence of clinical benefit.
- Radiotherapy:
  - no established role in the management of adrenal carcinoma, as it is rarely effective
  - occasionally used for the treatment of symptomatic metastases, usually in bone.

### *Medullary tumours*

- Anti-hypertensive medication:
  - may be required for phaeochromocytomas with residual or unresectable disease to control the BP.
- <sup>131</sup>I-MIBG:
  - if the tumour takes up the radionuclide MIBG, a therapeutic dose may be administered
  - symptomatic, hormonal, and radiological improvements can be seen, although these are transient
  - the treatment can be repeated.
- Radiotherapy:
  - appropriate for painful skeletal metastases.
- Chemotherapy:
  - may be considered for tumours that will not take up MIBG
  - a combination of dacarbazine, vincristine, and cyclophosphamide shows activity.

## **Prognosis**

### *Adrenocortical tumours*

- Almost all patients with benign disease are cured by surgery (usually laparoscopic).
- The prognosis is poor for patients with malignant disease. Untreated, the median survival is 3–9mo. Even if the carcinoma is small volume and apparently confined to the adrenal gland, survival following surgery may be as little as 14–36mo.
- The prognosis may be better in children.

### *Medullary tumours*

- Surgical resection is not always curative, even in benign disease. Long-term monitoring is therefore required. Subsequent recurrence may have malignant characteristics.
- The 5y survival for malignant phaeochromocytoma is <50%, although some patients live for many years without significant symptoms.

## Neuroblastoma

- The commonest extracranial solid tumour in childhood.
- Incidence—peak age 1–3y.
- Tumours arise in sympathetic nervous tissue:
  - 60% adrenal or elsewhere within the abdomen → pain, abdominal distension, general malaise
  - 15% intrathoracic → cough, pain, Horner's syndrome, incidental finding on CXR
  - ± bone or bone marrow metastases → non-specific limb, joint, or back pain, often misdiagnosed as arthritis or an irritable hip. May also become pancytopenic from marrow involvement.
- Investigations:
  - abdominal USS
  - CT/MRI of the chest and abdomen
  - MRI of the spine
  - urinary catecholamines
  - bloods, including serum LDH (elevation is a poor prognostic sign)
  - serum neuron-specific enolase (NSE)
  - ± technetium or <sup>123</sup>I-MIBG scan.
- Pathology:
  - ranges from an undifferentiated, small, round cell tumour (that may be difficult to distinguish from rhabdomyosarcoma, primitive neuroectodermal tumour (PNET), or NHL) to a highly differentiated ganglioneuroblastoma
  - biopsy can be done percutaneously, thorascopically, or with the laparoscope.

### Management

- Depends on the tumour stage and the presence of certain genetic features that may indicate a less good prognosis, e.g. amplification of the *n-myc* oncogene.
- 'Watch and wait' policy—an option for tumours of early stage with favourable biology. Spontaneous regression can be seen.
- Surgical clearance:
  - if possible
  - most thoracic, pelvic, and cervical primaries, and those abdominal tumours that do not cross the midline, are resectable
  - even subtotal resection in infants is beneficial
  - local recurrences can be usually managed surgically
  - many centres offer resection to patients with stage IV neuroblastoma, and, if combined with systemic therapy, there is some evidence of benefit.
- Neoadjuvant chemotherapy:
  - may be used with the aim of making a localized, but inoperable, tumour resectable
  - chemotherapy is also used in disseminated, high-risk disease
  - occasionally, high-dose chemotherapy, followed by autologous haemopoietic stem cell rescue, may be considered.

- Radiotherapy:
  - following incomplete resection or for tumours that remain unresectable after induction chemotherapy.

### Prognosis

- Depends on the stage of the tumour (see Table 18.3), tumour genetics, and the age at diagnosis.
- Children <1y old have a good prognosis, even in the presence of widely disseminated disease, e.g. OS of 85% for stage 4S.
- This compares with an OS of <40% in children >5y old with neuroblastoma of any stage.

**Table 18.3** International staging system for neuroblastoma

Stage 1	Localized tumour with complete gross excision, with or without microscopic residual disease; representative ipsilateral and contralateral lymph nodes negative for tumour microscopically (nodes attached to, and removed with, the 1° tumour may be positive)
Stage 2a	Localized tumour with incomplete gross excision; representative ipsilateral and non-adherent lymph nodes negative for tumour microscopically
Stage 2b	Localized tumour with complete or incomplete gross excision; with ipsilateral non-adherent lymph nodes positive for tumour. Enlarged contralateral lymph nodes must be negative microscopically
Stage 3	Unresectable unilateral tumour infiltrating across the midline, with or without regional lymph node involvement; or localized unilateral tumour with contralateral regional lymph node involvement; or midline tumour with bilateral extension by infiltration (unresectable) or by lymph node involvement
Stage 4	Any 1° tumour with dissemination to distant lymph nodes, bone, bone marrow, liver, skin, and/or other organs (except as defined in stage 4S)
Stage 4S	Localized 1° tumour (as defined for stage 1, 2a, or 2b) with dissemination limited to skin, liver, and/or bone marrow (limited to infants <1y old)

## Further reading

- Almeida MQ, Hoff AO (2013). Recent advances in the molecular pathogenesis and targeted therapies of medullary thyroid carcinoma. *Curr Opin Oncol* **24**, 229–34.
- American Thyroid Association (ATA) Guidelines Taskforce on Thyroid Nodules and Differentiated Thyroid Cancer, Cooper DS, Doherty GM, Haugen BR, et al. (2009). Revised American Thyroid Association management guidelines for patients with thyroid nodules and differentiated thyroid cancer. *Thyroid* **19**, 1167–214.
- American Thyroid Association Guidelines Task Force, Kloos RT, Eng C, Evans DB, et al. (2009). Medullary thyroid cancer: management guidelines of the American Thyroid Association. *Thyroid* **19**, 565–612.
- Arnaldi G, Boscaro M (2012). Adrenal incidentaloma. *Best Pract Res Clin* **26**, 405–19.
- Aspinal SR, Ong SG, Wilson MS, Lennard TW (2013). How shall we manage the incidentally found thyroid nodule? *Surgeon* **11**, 96–104.
- Balasubramanian SP, Harrison BJ (2011). Systematic review and meta-analysis of sentinel node biopsy in thyroid cancer. *Br J Surg* **98**, 334–44.
- British Thyroid Association; Royal College of Physicians (2007). *Guidelines for the management of thyroid cancer*, 2nd edn. Available at: [http://www.british-thyroid-association.org/news/Docs/Thyroid\\_cancer\\_guidelines\\_2007.pdf](http://www.british-thyroid-association.org/news/Docs/Thyroid_cancer_guidelines_2007.pdf).
- Cheung NK, Dyer MA (2013). Neuroblastoma: developmental biology, cancer genomics and immunotherapy. *Nat Rev Cancer* **13**, 397–411.
- Dralle H, Sekulla C, Lorenz K, et al. (2012). Loss of the nerve monitoring signal during bilateral thyroid surgery. *Br J Surg* **99**, 1089–95.
- Elisei R, Pinchera A (2012). Advances in the follow-up of differentiated or medullary thyroid cancer. *Nat Rev Endocrinol* **8**, 466–75.
- Kirschner LS (2012). The next generation of therapies for adrenocorticoid cancers. *Trends Endocrinol Metab* **23**, 343–50.
- Nixon IJ, Shaha AR, Tuttle MR (2013). Targeted therapy in thyroid cancer. *Curr Opin Otolaryngol Head Neck Surg* **21**, 130–4.
- Perez CA, Santos ES, Arango BA, Raez LE, Cohen EE (2012). Novel targeted therapies for refractory thyroid cancer. *Head Neck* **34**, 736–45.
- Perros P, Boelaert K, Colley S, et al. (2014). Guidelines for the management of thyroid cancer. *Clin Endocrinol (Oxf)* **81** (Suppl 1), 1–122.
- Promberger R, Ott J, Kober F, et al. (2012). Risk factors for postoperative bleeding after thyroid surgery. *Br J Surg* **99**, 373–9.
- Smallridge RC, Ain KB, Asa SL (2012). American Thyroid Association guidelines for management of patients with anaplastic thyroid cancer. *Thyroid* **11**, 1104–39.

# Genitourinary cancers

- Renal cancer 404
- Wilms' tumour 412
- Cancer of the bladder and ureter 418
- Prostate cancer 424
- Management of prostate cancer 428
- Testicular cancer 434
- Management of testicular cancer 438
- Penile cancer 442
- Further reading 444

## Renal cancer

### Epidemiology and aetiology

- 3% of all cancers, 9300 cases annually in the UK.
- Increasing frequency with age, most >60y.
- 1.5 times commoner in men.
- Association with smoking (relative risk doubled).
- Other associations include urban dwellers, occupational exposure (e.g. asbestos, benzenes, cadmium, nitrosamines, aflatoxins), obesity, and chronic renal dialysis.

### Genetics

The vast majority of adult renal cancers are sporadic, but an inherited predisposition causes 2%, and these may be multifocal/bilateral.

- vHL syndrome (1/36 000 births):
  - *VHL* gene on chromosome 3 is a tumour suppressor gene
  - germline loss/mutation of this gene leads to a multiorgan syndrome, including cerebral haemangioblastoma and risk of RCC.
- Hereditary clear cell carcinoma (germline alteration in chromosome 3 without other features of vHL).
- Hereditary papillary renal carcinoma syndrome.
- Increased risk also in patients with autosomal dominant polycystic kidneys or tuberous sclerosis.

### Pathology

Adenocarcinomas make up 85% of renal cancers and arise from the renal tubular epithelium. These RCCs were previously known as 'hypernephroma' or 'Grawitz tumours' and demonstrate several histological types:

- clear cell (75%)
- papillary
- chromophobe
- sarcomatoid features may be observed in each of these and convey a worse prognosis.

RCC typically arises as a solitary mass in one pole of the kidney and, as it progresses, may invade directly through the renal capsule, along the renal vein towards the IVC or even into the right atrium, and via lymphatics to regional nodes (para-aortic). Systemic metastases are common; macroscopic spread is present in 25% at presentation, typically to the lung or bone, but also the liver, adrenals, brain, and skin.

Transitional cell carcinomas (TCCs) can arise within the urothelium of the renal pelvis and represent the majority of the remaining tumours. They vary from low-grade superficial papillary tumours to high-grade invasive TCCs with the propensity for direct invasion into perinephric tissues and lymphovascular spread.



## Investigations

Many are picked up on USS or IV urography (IVU), but CT is the preferred imaging modality. Contrast-enhanced CT scan of the abdomen characteristically shows an enhancing mass, at least partly solid. CT should also be used to image:

- the chest, for lung and mediastinal lymph node metastases
- extrarenal direct tumour extension, e.g. into the psoas muscle
- renal vein and IVC tumour thrombus
- regional para-aortic lymph nodes
- spread to other organs, e.g. liver, adrenals, bones, and the contralateral kidney.

Biopsy is commonly omitted prior to surgical removal of renal cancer because of the risk of haemorrhage and tumour seeding along the biopsy tract. However, lesions 1.5–3cm in diameter are not infrequently benign, so biopsy under USS or CT is often performed prior to surgery for these, and for cases with advanced metastatic disease. Other required investigations include:

- FBC, biochemical profile
- isotope bone scan, particularly in patients with bone pain or elevated alkaline phosphatase (note that renal bone metastases may be photopenic or invisible on bone scan)
- CT of the brain if there is clinical evidence of CNS spread
- occasionally, MRI angiography or cavogram is required for locally advanced tumours to assess IVC extension
- isotope renogram to assess the function of the contralateral kidney if renal function impaired/small or scarred remaining kidney.

## Staging

The Robson staging system is simple and commonly used (see Table 19.1).

**Table 19.1** The Robson staging system

Stage	Description	% of cases	5y survival (%)
I	Confined to the kidney	20–40	50–60
II	Extends into peri-renal fat, but confined to Gerota's fascia	4–20	30–60
III	Involvement of renal vein or IVC or lymph node involvement	10–40	20–50
IV	Involvement of adjacent organs or metastatic disease	11–50	0–20

**Presenting symptoms and signs**

Up to 30% are asymptomatic and are discovered coincidentally during abdominal imaging for other reasons. Symptoms may relate directly to the 1° tumour, but paraneoplastic effects are not uncommon:

- haematuria (50%)
- loin pain (50%)
- palpable mass (30%)
- anaemia (40%)
- weight loss (35%)
- pyrexia (20%)
- hypertension (37%)
- hypercalcaemia (6%)
- polycythaemia (<5%).

Renal tumours may invade directly into the adjacent psoas muscle or lumbar spine, causing pain, or may present *de novo* with symptoms from metastatic disease in the lungs, lymph nodes, bone, brain, or skin.

**Surgery**

Resection of all the tumour is the only established curative treatment and should be offered to patients with operable disease without metastases, who are fit for surgery. Patients with metastatic disease, but good performance status and resectable 1° tumour, may benefit from nephrectomy as a palliative procedure or to prevent the development of local symptoms:

- to provide control of local symptoms
- nephrectomy, followed by immunotherapy, provides a modest survival benefit, compared with immunotherapy alone
- although there are documented cases of regression of metastases following nephrectomy, this is extremely rare (<1%), and nephrectomy cannot be justified on this basis in patients who are frail or have extensive metastatic disease.

**Surgical notes**

- Radical nephrectomy includes the removal of Gerota's fascia and its contents, including the kidney and adrenal gland:
  - some surgeons believe that the adrenal gland can be left safely
  - laparoscopic nephrectomy is commonly performed to decrease the morbidity of the open procedure—survival seems equivalent to the open procedure.
- Partial nephrectomy (open or laparoscopic) is performed for small localized tumours or in patients without a second kidney, or in the rare case of bilateral renal cancer. Laparoscopic partial nephrectomy can be difficult, but, with small tumours, survival seems to be equivalent to the radical procedure in selected cases.
- For patients who are frail or elderly, small tumours may not require resection but can be successfully managed by percutaneous RFA.
- Surgery for solitary metastases (e.g. lung, brain) is indicated for isolated metastases, particularly those that occur after a long (>1y) disease-free interval, and can result in prolonged survival in up to 30%.

Although surgery is the cornerstone of management of localized disease, some patients are unfit for nephrectomy or their tumour is unresectable. Tumour embolization (infarction) may provide some tumour control but can itself cause considerable morbidity. In some elderly asymptomatic patients, conservative management is appropriate, and tumour growth may be slow.

### Spontaneous remissions

One of the most pervasive tales of 'oncological folklore' is the expectation of spontaneous remissions in renal cancer. Although these certainly occur, the true rate is <1%, and they tend to occur in metastases following resection of the 1° tumour or after an episode associated with immune activation such as that following severe sepsis. Such regressions are not usually durable.

### Adjuvant therapy

Given the relatively high frequency of systemic relapse after surgery for stages I–II renal cancer, there is a clear need for effective adjuvant therapy. Cytotoxic chemotherapies, endocrine therapy, radiotherapy, and immunotherapy have been tested. However, none of these adjuvant therapies has been demonstrated to provide a survival benefit when combined with nephrectomy. Clinical trials using novel targeted agents are ongoing (see ↻ Targeted therapy for renal cell carcinoma, p. 409; ↻ Current trials of targeted adjuvant therapy in RCC, p. 411.).

### Radiotherapy

Renal cancer, in general, is relatively radioresistant. Palliative radiotherapy is appropriate for:

- a painful or bleeding 1° tumour
- non-resectable metastatic disease, e.g. bone, brain, soft tissue.

Higher palliative doses and large doses per fraction, compared with other malignancies, may be appropriate to give durable control of the disease, in particular with isolated non-resectable metastases after nephrectomy in patients with good performance status.

### Endocrine therapy

Progestins were widely prescribed for advanced renal cancer, following the identification of PRs in some renal tumours and the observation of anti-tumour activity in animal models. The objective response rate for systemic progestagen therapy is <10% and probably only 1–2% by modern response criteria. However, the anabolic effects of progesterone may be valuable in patients with advanced disease, whose QoL may improve on this treatment. These agents increase the risk of venous thromboembolic disease, which is already high in this disease.

### Chemotherapy

Cytotoxic drugs are of little value in renal carcinoma. The chemoresistance may, in part, be due to the high expression of an MDR phenotype in both normal and malignant renal tissue. Response rates for single agents are generally under 10%. Fluorouracil is one of the consistently active agents, and recent interest has focused on the combination of gemcitabine and fluorouracil.

**Biological therapy**

The management of patients with unresectable and/or metastatic renal cancer is palliative. There is, however, good evidence that a small subset of patients, who have complete responses to biological therapy, may enjoy disease-free survival for several years.

Biological therapy has been extensively tested in renal cancer, partly because of its chemoresistance, but also because of the presumption that immunological mechanisms underlie:

- occasional spontaneous regression of metastases
- very late relapses in some patients
- an increased incidence of renal cancers in immunosuppressed patients.

*Interleukin-2*

- Most widely tested biological agent in advanced renal cancer.
- Induces responses in 10–25% of patients with advanced disease.
- Patients with a complete radiological response have a significant survival benefit, with remissions of several years in a few.
- Original studies of IL-2 employed high-dose IV IL-2, either alone or in combination with LAK cells.
- No evidence from randomized studies that LAK cells improve the efficacy of IL-2.
- These regimens are associated with serious morbidity, in particular capillary leak syndrome, including hypotension and pulmonary oedema.
- Less toxic s/c IL-2 regimens are probably equally effective and can be combined with other agents, perhaps with greater anti-tumour effects.
- Other toxicities include flu-like symptoms and effects on bone marrow, hepatic, and renal function, and the CNS and thyroid.

*Interferon alfa*

- Was been the preferred biological treatment for advanced renal cancer in the UK until 2009.
- As a single agent, s/c IFN provides a response rate of 8–15% but without prolonged remissions.
- An MRC trial compared s/c IFN with medroxyprogesterone acetate in the treatment of metastatic renal cancer, and demonstrated a modest improvement in median survival with s/c IFN (8.5mo versus 6mo).
- Toxicities of this drug are significant but not life threatening, in particular flu-like symptoms, lethargy, anorexia, and nausea.
- Other side-effects include deranged LFTs, and effects on bone marrow, renal function, and CNS.

Prognostic factors that predict higher response rates and prolonged survival time after biological therapy include:

- long disease-free interval
- previous nephrectomy
- good performance status (0–1)
- normal LDH, Hb, Ca<sup>2+</sup>
- pulmonary metastases as the sole site of disease.

*Combined biological therapy and chemotherapy*

Although phase II studies have reported higher objective response rates with combinations of IL-2 and IFN, with or without chemotherapy, so far

phase III studies have failed to demonstrate a significant benefit with any one combination regimen. The MRC RE04 study compared an IL-2/IFN/fluorouracil regimen, developed by German investigators led by Atzpodien, with a reported response rate of >30%, against single-agent IFN. Disappointingly, although the response rate was higher with the combination regimen (24% versus 16%), survival was equivalent in both arms (median survival of 18mo).

### Targeted therapy for renal cell carcinoma

(See Table 19.2.)

The systemic treatment of this disease has been transformed in the last few years with the advent of treatments targeted against VEGF. The majority of sporadic clear cell carcinomas of the kidney demonstrate an inactivation of the tumour suppressor gene *VHL*, with resultant overexpression of VEGF. The pro-angiogenic effects of VEGF are mediated by its activation of the VEGF cell surface receptor, and this has proved a fruitful target for therapies.

Table 19.2 Targeted therapies for renal cell cancer

Drug	Dose regimen	Licensed indications	Side effects
Sunitinib	50mg PO daily for 4wk, then 14-day break	First-line therapy advanced disease in good-risk patients	Fatigue, nausea, stomatitis, diarrhoea, hypertension, hand-foot syndrome, bleeding/bruising, hypothyroidism, cardiac dysfunction, rarely GI perforation
Pazopanib	800mg PO daily	First-line therapy advanced disease in good-risk patients	As above, but with less fatigue, stomatitis, and hand-foot syndrome
Sorafenib	400mg PO bd	Second-line therapy after IFN	Skin rashes, diarrhoea, hypertension, hand-foot syndrome
Temsirolimus	25mg IV weekly	First-line therapy in poor-risk patients	Lethargy, skin rash, hyperglycaemia, hyperlipidaemia
Bevacizumab	10mg/kg IV every 2wk, in combination with IFN	First-line therapy advanced disease	Fatigue, hypertension, bleeding, rarely GI perforation
Everolimus	10mg PO daily	Second-line therapy after sunitinib or sorafenib	Lethargy, stomatitis, diarrhoea, cough
Axitinib	5mg PO bd Increasing to 7–10mg bd if no toxicity	Second-line therapy	Diarrhoea, hypertension, fatigue

**Neutralizing antibody against vascular endothelial growth factor**

Bevacizumab is a recombinant human mAb against VEGF:

- bevacizumab plus IFN improves the response rate and PFS, compared with IFN alone (responses in 25% versus 13%).

**Small molecule inhibitors of vascular endothelial growth factor receptor pathway**

- Sunitinib—oral TKI:
  - sunitinib versus IFN study—750 patients with metastatic clear cell RCC, no previous systemic therapy
  - objective response rate of 47% versus 12%, with improved PFS (11mo versus 5mo) and OS (26.4mo versus 21.8mo).
- Sorafenib—oral TKI:
  - sorafenib versus placebo study—903 patients with metastatic clear cell RCC, one previous systemic therapy, no previous VEGF pathway inhibitor therapy
  - response rate relatively low (10%), but a large number of patients had prolonged stable disease, PFS (5.5mo versus 2.8mo).
- Pazopanib—oral TKI, similar anti-tumour activity, compared with sunitinib, but possibly less toxicity.
- Temozolomide—oral inhibitor of mTOR, key component in the intracellular control of angiogenesis and cell cycle:
  - temsirolimus versus IFN in poor-prognosis advanced renal cancer—3.6mo survival benefit
  - everolimus—oral analogue, an mTOR inhibitor, has demonstrated significant benefit as second-line therapy after sunitinib or sorafenib.
- Axitinib—oral TKI, has also shown significant improvement in PFS as second-line therapy

Despite these results and the approval for their use in this disease in Europe and the US, NHS patients are currently denied access to most of these on the grounds of cost efficacy. Indeed, sunitinib was only approved by NICE in 2009 for the treatment of renal cancer patients, joined by pazopanib in 2011, both as first-line therapy.

**Management of transitional cell carcinoma**

These tumours arise in the renal collecting system and may be associated with TCC in the ureter and bladder. Their biology, management, and prognosis are similar to those of TCC of the ureter.

**Treatment outcomes**

The prognosis for non-metastatic renal carcinoma is related to the pathological stage of the disease post-nephrectomy, with 5y survival rates between 60 and 20%, as in Table 19.1.

Although the prognosis for metastatic renal cancer is poor, with a median survival time of <1y, the outlook for good-prognosis patients, as defined in  Interferon- $\alpha$ , p. 408, is better, with a median survival of >2y.

### Controversies in the treatment of renal cancer

Current areas of uncertainty in advanced disease include:

- the optimum use of targeted therapies, sequence, or combination
- the prediction of response to targeted therapies
- the importance of nephrectomy as an adjunct to these therapies
- the role of immunotherapy after targeted therapy
- targeted therapy for non-clear cell RCC.

#### *Current trials of targeted adjuvant therapy in RCC*

Ongoing randomised controlled trials using axitinib, everolimus, pazopanib, sorafenib, and sunitinib as post-operative adjuvant therapy will report over the next few years.

## Wilms' tumour

Wilms' tumour (WT) is an embryonal neoplasm arising in the kidney and the commonest abdominal malignancy in childhood. Multidisciplinary management in specialist centres, combined with international collaborative research over the last 40y, has resulted in cure rates rising from 50% to currently almost 90%.

### Epidemiology

- Accounts for ~6% of childhood malignancies.
- Around 70 cases per annum in the UK.
- ♂:♀ ratio ~1.
- Peak age at diagnosis 3–4y.
- Rare after the age of 10y, but occasionally present in adults.
- A number of conditions are associated with the development of WT:
  - congenital genitourinary abnormalities
  - hemihypertrophy
  - aniridia.

However, the majority of patients demonstrate none of these features.

### Genetics

*WT1* is a tumour suppressor gene, located on chromosome 11, constitutively deleted in patients with WAGR syndrome (Wilms' tumour Associated with Aniridia, Genitourinary abnormalities, and mental Retardation). This gene is also mutated or deleted in a number of sporadic cases of WT. Beckwith–Wiedemann syndrome (WT associated with overgrowth) is also linked with changes in chromosome 11, involving a second Wilms' tumour locus, *WT2*. A third Wilms' tumour gene *WTX* has been identified on the X chromosome.

### Presenting symptoms and signs

- Abdominal mass, smooth, rounded, or lobulated arising in the loin.
- Pain.
- Haematuria.
- Fever, weight loss.
- Hypertension.

### Investigations

- Abdominal USS to confirm the organ of origin of the mass, determine the extent of spread within the abdomen, confirm the patency of the IVC.
- CXR to detect pulmonary metastases.
- FBC, biochemistry.
- Clotting screen—may acquire von Willebrand disease.
- Urinalysis.
- Urinary catecholamines to exclude neuroblastoma.
- Staging CT scan of the chest and abdomen.

It is important to know that the contralateral kidney is functioning adequately before surgery, and IVU, dimercaptosuccinic acid (DMSA) scan, or excretion of contrast at the end of a CT scan of the chest/abdomen are useful in this role.



## Pathology

Two broad groups of tumours may be recognized by their histological appearances.

### *Favourable histology (90%)*

- Classical triphasic histology—epithelial, blastemal, and stromal elements are all present.
- Rhabdomyoblastic differentiation.
- Monomorphic epithelial variant.

### *Unfavourable histology*

- Anaplasia is an unfavourable feature, occasionally observed in triphasic tumours.
- The major unfavourable histological types are probably distinct cancers, rather than true variants of WT:
  - bone-metastasizing renal tumour of childhood
  - malignant rhabdoid tumour.

## Staging

The National Wilms' Tumor Study Group (NWTSG) staging system is commonly used:

- *stage I*—tumour confined within the renal capsule and fully resected
- *stage II*—tumour beyond the renal capsule, but fully resected; preoperative biopsy; ruptured; confined to the flank
- *stage III*—tumour outside the capsule and incompletely resected; lymph node involvement at the hilum or para-aortic chain
- *stage IV*—haematogenous metastases, e.g. to the lungs, liver, bone, or brain
- *stage V*—bilateral renal tumours.

## Management

There is overwhelming evidence that WT must be treated only in paediatric oncology centres, and there is no place for the casual therapist. Surgeons, radiotherapists, paediatricians, or nephrologists not working in a centre with paediatric oncological expertise who find themselves unexpectedly dealing with a child with WT should make an urgent referral to an appropriate unit.

### *Surgery*

Surgical resection is, and almost certainly will remain, the cornerstone treatment for WT. There is debate about the timing of surgery, the place of percutaneous needle biopsy, and the use of preoperative chemotherapy. US practice (NWTSG) remains steadfastly in favour of immediate surgery, followed by adjuvant therapy dictated by the surgical stage. In contrast, the International Society of Paediatric Oncology (SIOP) group in Europe has conducted a series of trials, based on the use of preoperative therapy, and, whilst it remains to be proven that the latter approach is superior, there is increasing recognition that preoperative treatment may be of benefit in some circumstances. Only 5% are suitable for partial nephrectomy. Usually surgery is done by open technique (*not* laparoscopic) (best by a specialized paediatric surgeon) with wide excision, taking care to avoid rupture or spillage of the tumour. The latter is associated with peritoneal recurrence.

In bilateral tumours, one tumour is usually smaller and may be amenable to partial nephrectomy.

**Adjuvant therapy**

The use of chemotherapy and radiotherapy as adjuvants to surgery is now an essential part of WT treatment. Major advances in treatment have come as a result of multicentre cooperative trials run by the US NWTS group (see Table 19.3), SIOP, and the UK Children's Cancer Study Group (UKCCSG).

In general, treatment is tailored to the stage and pathology of the individual child, each successive study aiming to maximize the probability of cure, but minimize exposure to chemotherapy and radiotherapy. For example, radiotherapy can now be safely omitted in patients with stages I and II, with favourable histology.

The initial studies of adjuvant chemotherapy used vincristine and dactinomycin, and these remain the mainstay of treatment for the majority of patients. Doxorubicin improves the outcome in stages III and IV, and other agents, such as carboplatin, etoposide, and cyclophosphamide, are active in poor-prognosis and relapsed disease.

**Outcome of treatment**

The favourable outcome of treatment for the majority is illustrated in Table 19.4 and Table 19.5. Currently, around 75% of children with WT can be successfully treated without doxorubicin or radiotherapy, minimizing the risk of late effects. Nonetheless, close follow-up, including CXR and abdominal USS, is mandatory. Following relapse, long-term survival of 30–40% may be achieved through salvage therapy (see Table 19.6 for current treatment).

Late effects may include the impairment of:

- growth
- lung function
- cardiac function
- renal function
- hepatic function
- fertility
- second malignancy.

Table 19.3 Main findings in NWTS 1, 2, and 3

NWTS 1	
Group I	Patients under 2y of age do not all need radiotherapy
Groups II/III	AMD plus VCR is better than either alone
Group IV	Preoperative VCR is of no benefit
Other findings	Unfavourable histology and lymph node involvement are adverse features
NWTS 2	
Stage I	No patient benefit from radiotherapy, regardless of age; 6mo of VCR and AMD is as good as 15mo
Stages II, III, and IV	Addition of doxo to VCR and AMD improves survival
Other findings	Stages II and III have the same survival. Local spillage and invasion of the renal vein do not affect outcome
NWTS 3	
Stage I	10wk therapy with VCR/AMD is as effective as 6mo
Stage II	Intensive VCR/AMD is as effective as three drugs; addition of radiotherapy does not affect survival
Stage III	Intensive VCR/AMD is as effective as three drugs; 10Gy flank irradiation is as effective as 20Gy
Other findings	Addition of cyclophosphamide to VCR/AMD/doxo does not improve survival

AMD, actinomycin; doxo, doxorubicin; VCR, vincristine.

Table 19.4 Outcome for patients in NWTS III

Stage	2y relapse-free survival (%)	2y OS (%)	Treatment
I	92	97	10wk vincristine plus actinomycin D
II/III	87	91	15mo vincristine plus actinomycin D plus doxorubicin
III	78	86	10Gy plus vincristine plus actinomycin D plus doxorubicin
IV plus UH	72	81	

UH, unfavourable histology.

**Table 19.5** Outcome for patients in UKW1 study

Stage	3y event-free survival (%)	3y OS (%)	6y event-free survival (%)	6y OS (%)
I	90	96	89	96
II	85	94	85	93
III	82	83	82	83
IV	58	65	50	65

**Table 19.6** Current treatment for WT

Stage	Treatment
I, low risk	No adjuvant therapy
I, intermediate risk	Adjuvant vincristine, actinomycin
I, high risk	Adjuvant vincristine, actinomycin, doxorubicin
II, low risk	Vincristine, actinomycin
II–III, intermediate risk	Vincristine, actinomycin, $\pm$ doxorubicin
II–III, high risk	Cyclophosphamide, doxorubicin, etoposide, carboplatin, and radiotherapy
Metastatic	Neoadjuvant vincristine, actinomycin, doxorubicin, then surgery, then further chemotherapy $\pm$ etoposide, carboplatin, and radiotherapy



## Cancer of the bladder and ureter

### Epidemiology

- Fourth commonest ♂ cancer.
- ♂:♀ ratio ~2:1.
- 10 500 new cases in the UK each year.
- Two-thirds occur aged >70y.

### Aetiology

- Cigarette smoking increases the risk by 2–6-fold.
- Occupational exposure to a number of carcinogens, including aromatic amines, is associated with an increased risk, with a latent interval of 20–30y.
- Occupations at risk include:
  - aniline dye and the rubber industries
  - gas and foundry works
  - rodent care and other laboratory work
  - sewage treatment
  - textile printing
  - firelighter manufacturers.
- Chronic irritation of the bladder, e.g. infection, stones, long-term catheter, or schistosomiasis—associated with squamous cancer of the bladder.
- Previous pelvic radiotherapy, e.g. for gynaecological cancer.

### Pathology

The majority (>90%) of urothelial tumours presenting in the UK are TCCs. Less common pathologies include:

- squamous carcinomas associated with chronic irritation
- adenocarcinomas arising from urachal remnants in the bladder dome
- metaplasia in a TCC may give rise to carcinosarcoma or neuroendocrine carcinoma, both associated with poor outcome.

Typically, the disease presents with a superficial tumour involving only the bladder epithelium, but, in 25%, there is tumour invasion into the detrusor muscle of the bladder, and 5% present with metastatic disease to the regional lymph nodes, lung, liver, or bone. Pathological grading (I–III) correlates well with the natural history of the disease. Multifocal disease is not uncommon, although exposure of the entire lining of the urinary tract to the relevant carcinogens and a history of TCC of the bladder carry an increased risk of TCC arising anywhere in the urothelium.

### Genetics

No convincing evidence of a hereditary predisposition exists. TCCs have a number of characteristic chromosomal abnormalities, including, in particular, the loss of chromosome 9. Other common abnormalities include a mutation of the *p53* gene that appears more often in advanced cancers and has been associated with an increased risk of treatment failure.

## Staging (TNM)

See  <https://cancerstaging.org> to download the TNM staging. The management and prognosis of TCC of the bladder are largely determined by the stage of the disease and its pathological grading. There is a strong association between well-differentiated tumours and early stage at presentation.

Seventy per cent of new patients present with superficial disease, of which at least half have Ta tumours. Although around 50% of these develop recurrent superficial bladder cancers, few progress to advanced disease. CIS has a worse outlook, with up to 60% progressing to invasive disease if recurrent disease is not eradicated.

There is a significant risk of metastatic disease with high-grade T1 disease, and this rises with increasing stage of muscle-invasive disease.

## Investigations

- FBC, biochemistry profile.
- Cystoscopy and transurethral resection of bladder tumour (TURBT):
  - provide the pathological diagnosis and stage
  - should include resection through the underlying detrusor muscle to confirm/refute muscle invasion
  - biopsy other areas of abnormal-looking epithelium (CIS often appears as a red patch)
  - following cystoscopic resection, pelvic examination under anaesthetic should confirm the presence/absence of a residual pelvic mass (presence indicates at least T3 disease).
- For low-grade superficial tumours, no further imaging is required. High-grade superficial tumours do carry a significant risk of synchronous disease in the upper urinary tract and should have an IVU or, more commonly, a CT urogram after diagnosis.
- For G3 pT1 and muscle-invasive disease, staging with CXR and either CT or MRI scan of the abdomen and pelvis is required, looking particularly at:
  - the tumour extent in the bladder and extravesical extension of the tumour into adjacent fat/organs
  - pelvic and para-aortic lymphadenopathy
  - ureteric obstruction
  - bone, liver, and lung metastases.

## Presentation

- 80–90% have frank haematuria, usually painless.
- Irritative bladder symptoms, e.g. frequency and dysuria, may be associated with muscle-invasive disease or CIS
- Less often present with unexplained microscopic haematuria.
- Asymptomatic disease may be picked up at routine cystoscopy in patients with previous bladder cancer or upper tract TCC.

**Management options***Superficial tumours (70% newly diagnosed cases)*

- Ta and low-grade (G1–2) T1 tumours are resected cystoscopically.
- A single post-resection infusion of intravesical mitomycin reduces the risk of recurrence.
- Because of the risk of recurrent disease, regular cystoscopic follow-up is required.
- Recurrent disease managed by intravesical therapy with mitomycin, epirubicin, or BCG.
- Tis commonly responds to intravesical BCG, but recurrences are common and may be multifocal.
- Refractory Tis often best managed by cystectomy.
- G3T1 tumour management is controversial:
  - >50% risk of recurrence, up to half of which may be invasive TCC
  - significant risk of regional and metastatic disease
  - initial treatment of solitary tumour often comprises TURBT, followed by intravesical therapy
  - multifocal or recurrent disease requires staging and management as for muscle-invasive disease
  - radiotherapy is not of benefit in preventing recurrence.

*Muscle-invasive bladder cancer*

Given the high rate of recurrence and metastatic spread after TURBT, all patients with invasive disease should be considered for further treatment. Options should be discussed both by the MDT and with the patient, including:

- radical cystectomy
- radiotherapy and bladder conservation
- neoadjuvant or adjuvant chemotherapy.

*Radical surgery*

The usual procedure is cystoprostatectomy in ♂ patients or anterior bladder exenteration in ♀ patients, with dissection of local lymph nodes. Bladder resection is associated with urinary diversion, most commonly a non-refluxing ileal conduit and urinary bag. Complications include loss of erectile function in the ♂ and shortening of the vagina in the ♀. It is important for patients to have advice from a stoma therapist before surgery.

Increasingly, excellent results can be achieved in selected patients treated by radical cystectomy with continent diversion, based on urinary tract reconstruction by ileocystoplasty. This can produce urinary continence, and, in experienced centres, the surgical complication rates are <10% and operative mortality <2%.

The role of laparoscopic cystectomy and robotic surgery is currently unclear.



### Radical radiotherapy

Many UK patients with invasive TCC of the bladder, in particular the elderly with significant co-morbidities, have been treated with radiotherapy.

- Radiotherapy is planned, using a CT scan, to define the target volume.
- Conventionally, the entire bladder and prostatic urethra are treated using a 3- or 4-field plan.
- Common treatment regimens include 64Gy/32 fractions or 52.4Gy/20 fractions.
- Side effects include cystitis and diarrhoea, and late reduction in the bladder capacity.
- Cystoscopic follow-up is particularly important:
  - to diagnose and resect recurrent bladder tumour
  - to offer salvage cystectomy to selected patients with recurrent invasive disease who remain fit for surgery.
- Frail patients unfit for radical surgery or radiotherapy may benefit from short-course palliative radiotherapy to the bladder, ideally CT-planned, e.g. 21Gy/three fractions/5 days.
- A number of studies have reported improved results when radical radiotherapy is combined with systemic chemotherapy, either given prior to radiotherapy or concomitant with radiotherapy.
- For patients with unifocal bladder cancer, it may be unnecessary to irradiate the whole bladder, and clinical trials are under way, exploring the benefits of partial bladder radiotherapy  $\pm$  chemotherapy.

Table 19.7 compares these two treatment modalities. Surgery remains the preferred option for many patients with good performance status, particularly those with multifocal disease and/or irritative bladder symptoms.

**Table 19.7** Surgery versus radiotherapy as curative treatment for invasive bladder cancer

	Radical surgery	Radical radiotherapy
In favour	Complete pathological staging Best local and loco-regional control rates Best survival rates	Bladder conservation Option for salvage cystectomy Feasible in patients with extravesical extension and significant co-morbidities
Against	Major pelvic surgery, not feasible in many patients because of co-morbidities and frailty Loss of normal bladder and sexual function	Poor results in multifocal disease and Tis Normal tissue damage, radiation cystitis, and enteritis May worsen urinary symptoms by reducing bladder capacity

**Chemotherapy**

(See Table 19.8.)

Combination chemotherapy has an established role in the palliation of patients with advanced bladder cancer. Cisplatin-based regimens, such as MVAC (MTX, vinblastine, doxorubicin, cisplatin), were developed in the 1980s and found to have high objective response rates (~50%), although few patients survive beyond 2y. During this time, the preferred regimen in the UK was CMV (cisplatin, MTX, vinblastine, no doxorubicin).

These regimens were found to be toxic, especially for patients with poor performance status and impaired renal function. Life-threatening toxicity, e.g. neutropenic sepsis, was common. The combination of gemcitabine and cisplatin has been shown to be as effective as MVAC, with reduced toxicity, and has largely superseded the older regimen.

In view of the chemosensitivity of this disease, a number of trials have examined the benefits of neoadjuvant and adjuvant chemotherapy, in combination with either surgery or radiotherapy. A meta-analysis of these trials has demonstrated that cisplatin-based chemotherapy given before cystectomy or radical radiotherapy affords a modest survival benefit, ~5% improvement at 5y. Patient selection for this treatment is crucial, but fit patients with muscle-invasive disease should be considered for chemotherapy prior to local treatment.

Recent results from the UK study of synchronous chemo-irradiation with the relatively non-toxic combination of mitomycin and fluorouracil, compared with radiotherapy alone, have shown significant improvement in the local control of bladder cancer with combined modality treatment which can be delivered in patients unfit for cisplatin-based chemotherapy.

**Future treatments**

- Other cytotoxics, including the taxanes, are active in this disease.
- Molecular-targeted therapies are being investigated.
- Molecular markers are being sought, which may optimize the selection of local treatment (surgery versus radiotherapy) for individual patients.

**Treatment outcomes**

The prognosis for superficial disease is good, with 5y survival rates in excess of 80%.

The outlook for invasive disease is less good, with estimated 5y survival rates after cystectomy:

- T2, 50–70%
- T, 30–40%
- T4, 20%.

There are no randomized studies comparing the results of bladder conservation using modern radiotherapy against 1° treatment with radical cystectomy. Many patients treated with radiotherapy would not be candidates for radical surgery but may still achieve successful bladder conservation. The best results with radical radiotherapy appear to follow TURBT for a solitary T2 tumour. Poor results are obtained with T4 disease and squamous carcinomas.

For metastatic disease, treatment with chemotherapy is associated with a median survival time of around 1y, but <10% survive 2y.

**Table 19.8** Examples of chemotherapy regimens for bladder cancer

MVAC		
MTX	30mg/m <sup>2</sup> days 1, 8, 15	q 4wk
Vinblastine	3mg/m <sup>2</sup> days 2, 8, 15	
Doxorubicin	30mg/m <sup>2</sup> day 2	
Cisplatin	70mg/m <sup>2</sup> day 2	
CMV		
MTX	30mg/m <sup>2</sup> days 1 and 8	q 3wk
Vinblastine	4mg/m <sup>2</sup> days 1 and 8	
Cisplatin	100mg/m <sup>2</sup> day 2	
Gemcitabine cisplatin		
Gemcitabine	1000mg/m <sup>2</sup> days 1, 8, 15	q 4wk
Cisplatin	70mg/m <sup>2</sup> day 2	
or		
Gemcitabine	1250mg/m <sup>2</sup> days 1 and 8	q 3wk
Cisplatin	70mg/m <sup>2</sup> day 1	

### Renal pelvis and ureteric transitional cell carcinoma

These uncommon tumours range from superficial low-grade disease to aggressive muscle-invasive cancer with a high propensity for distant spread. Presentation may be with ureteric obstruction, haematuria, or symptoms related to advanced disease. The tumour is commonly visible on IVU and may be biopsied via a flexible ureteroscope. Staging requires CT or MRI scan of the abdomen and pelvis, as well as cystoscopy to look for synchronous bladder TCC.

Localized disease is usually treated by nephroureterectomy with removal of a cuff of the bladder. Adjuvant therapy trials have not been conducted, but advanced disease may be treated with chemotherapy and palliative radiotherapy, as for TCC of the bladder.

## Prostate cancer

Cancer of the prostate gland is one of the most controversial malignancies with regard to its treatment. Despite its high incidence—now the commonest ♂ cancer in Europe and the US—for many men with this diagnosis, the optimum management is uncertain, with a spectrum of treatment options, ranging from active surveillance only to complex surgery or IMRT.

### Epidemiology

Prostate cancer has now overtaken lung cancer as the commonest ♂ cancer in the UK.

- >30 000 new cases per annum, and the incidence is continuing to rise.
- Lifetime risk 1 in 14 men.
- Rare in men aged <50y.
- 85% of men are diagnosed at age 65y or older.
- Autopsy studies have estimated that 70% of men aged >80y have histological evidence of cancer in the prostate.
- Despite the rising incidence, only 9500 deaths per annum are caused by prostate cancer in the UK, and many men with this diagnosis die of other causes.

### Aetiology

Its pathogenesis is clearly androgen-dependent, and men who are castrated or develop hypopituitarism before 40y rarely develop prostate cancer.

- Age is the most important risk factor.
- 5–10% of cases appear to be linked to the inheritance of a susceptibility gene, particularly cases arising at a young age.
  - At present, the only identified genes include *BRCA1* and 2, but these do not account for the majority of cases with a family history.
  - Linkage analysis suggests that there is a hereditary prostate cancer locus on chromosome 1q 24–25.
- Race—60% increased incidence in African-Americans, often with poor prognosis, compared with white Americans; uncommon in Asian men.
- Dietary factors may explain some racial differences.

### Pathology

Ninety-five per cent are adenocarcinomas; rare pathologies include neuroendocrine and TCCs; 70% arise in the peripheral zone of the gland, and many are multifocal.

The natural history of the disease correlates well with its histological grade, assessed by the Gleason score. Low-grade cancers (Gleason 6) are typically small and slow-growing, confined to the prostate gland. High-grade cancers (Gleason 8–10) grow faster and frequently invade through the prostate capsule, can directly infiltrate adjacent organs (seminal vesicles, bladder, rectum), and commonly disseminate early to regional lymph nodes and by vascular invasion, typically to bone, but also occasionally to the lung and liver.

## Screening for prostate cancer

Since the development of assays to measure serum prostate-specific antigen (PSA) to diagnose prostatic disease, this condition has been increasingly diagnosed at an earlier stage. In 1974, in the UK, >50% of patients presented with metastatic disease. Forty years later, the majority of patients are diagnosed with organ-confined disease as a result of PSA testing, with few, if any, symptoms of prostatic disease. Although population screening is not recommended in the UK (the topic is again currently under political review), PSA testing is recommended in all men with lower urinary tract symptoms and is also performed frequently as part of general health screening in 1° care. As a result, increasing numbers of patients are now diagnosed with asymptomatic early-stage disease.

### *Prostate-specific antigen*

Measurement of serum PSA has limitations as a screening test for prostate cancer. Conventionally, PSA >4 micrograms/L was viewed as an indication for prostatic biopsy. However:

- normal PSA range increases with age
- many centres have adopted these cut-off levels to guide the selection of patients for prostate biopsy:
  - 6.5 micrograms/L age >70y
  - 4.5 micrograms/L age 60–70y
  - 3.5 micrograms/L age 50–60y
  - 2.5 micrograms/L age 40–50y
- PSA may be elevated in the absence of prostate cancer, e.g. benign prostatic hyperplasia, prostatitis
- one in four men with PSA >4 micrograms/L will be found to have cancer on biopsy of the prostate
- but around one-third of prostate cancers will have PSA <4 micrograms/L
- specificity, but not sensitivity, can be improved by measuring free or total PSA, or both
- digital rectal examination findings are important—40% of men with a palpable abnormality have a tumour
- higher levels of PSA (>20 micrograms/L) correlate well with the tumour stage and grade.

### *Prostate-specific antigen screening in the United States*

Currently, PSA testing is recommended for all US men aged 50–75y, although the optimum frequency of testing is uncertain, with every 2–4y suggested. In the US, in 1995, with the widespread use of PSA testing in asymptomatic men, nearly 400 000 patients were diagnosed with prostate cancer; in the same year, ~38 000 patients died of prostate cancer. In Europe, with largely no screening, 85 000 patients were diagnosed, and around 20 000 died of prostate cancer. These figures suggest that too many cases of clinically insignificant disease were diagnosed in the US and treated without clear evidence of survival benefit. However, over the last 10y, the mortality rate from prostate cancer in the US has fallen, and advocates of PSA screening have claimed this as evidence of success of the programme.

Certainly, a number of positive features are observed in screen-detected prostate cancer:

- the majority have low-grade early-stage disease
- treatment outcomes are excellent, with most patients free of disease after 10y follow-up.

However, this is at enormous cost to health resources, with significant morbidity in a number of patients, many of whom were destined never to have clinically significant prostate cancer. Interestingly, the number of patients receiving radical treatment for prostate cancer in the UK has quadrupled in the last 15y, and it is anticipated that survival improvements, similar to those in the US, may be observed in UK prostate cancer deaths in the next decade.

#### *Clinical trials of prostate-specific antigen screening*

Conventionally, the establishment of population screening for a malignant disease requires that randomized studies have demonstrated that the screening process results in a reduction of mortality from the relevant cancer. Such trials have now been completed, in particular the American Prostate, Lung, Colorectal, and Ovarian (PLCO) Cancer Screening trial and the European Randomized study of Screening for Prostate Cancer trial. Initial reports show no reduction in prostate cancer mortality rates with PSA screening.

### **Staging**

The TNM staging system is used (see  <https://cancerstaging.org> to download the TNM staging).

### **Investigations**

Patients with lower urinary tract symptoms should have digital rectal examination and PSA testing offered. All patients having PSA tested should be counselled that:

- the test may detect cancer in ~5% of men aged 50–65y
- the test will fail to detect up to 25% of cancers
- biopsy and further treatment, if cancer is found, carry the risk of some morbidity, with no guarantee of improved life expectancy.

Asymptomatic patients with elevated PSA should also be assessed by digital rectal examination (40% of palpable nodules are malignant). Transrectal USS and prostatic biopsy are required for patients with PSA >4 micrograms/L or age-adjusted normal range, and patients with normal PSA but a palpable abnormality in the gland. Up to four biopsy cores are taken from each lobe, with antibiotic cover. The prostate volume is measured by ultrasound, relevant symptoms recorded, e.g. by the International Prognostic Scoring System (IPSS) questionnaire, and the urinary flow rate may also be measured.

In patients with biopsy-proven cancer, further investigation depends on the stage, grade, PSA, and planned treatment.

MRI scan of the prostate and pelvis provides the most accurate estimate of the loco-regional tumour extent for patients being considered for surgery or radiotherapy.

Isotope bone scans are required only for T3–4 tumours, Gleason 8–10, PSA >15 micrograms/L, or patients with symptoms/signs/biochemical evidence of bone metastases.

### Presenting symptoms and signs

- ~50% are asymptomatic with elevated PSA.
- Urinary symptoms, e.g. frequency, nocturia, poor stream, retention, haematuria:
  - these are commonly due to coincident benign prostatic hyperplasia
  - symptoms may be scored, e.g. using the IPSS.
- Locally advanced prostate cancer may cause:
  - impotence due to neurovascular bundle infiltration
  - haemospermia
  - ureteric obstruction and renal failure
  - rectal symptoms, e.g. tenesmus, bleeding
  - lymph node spread with lymphoedema in the legs and genitals
  - bone metastases with pain, fracture, nerve root or spinal cord compression, or malignant hypercalcaemia
  - rarely liver, pleura, or lung metastases.

## Management of prostate cancer

### Metastatic disease

Although distant spread of prostate cancer is incurable, the majority of patients can have excellent palliation of their symptoms and a survival time of at least 2y with appropriate therapy. The growth of prostate cancer is androgen-dependent, and a number of hormone treatment options are effective.

#### *Surgical castration*

- Achieves permanent reduction in circulating androgens.
- Inexpensive.
- Major toxicities include impotence and loss of libido, fatigue, mood disturbance, and muscle weakness.
- In long-term survivors, causes osteoporosis.
- May not be acceptable to patient.

#### *Medical castration*

- LHRH agonist, e.g. goserelin, buserelin, leuprorelin.
- Administered as depot s/c injection (expensive).
- Causes initial flare with a rise in testosterone, followed by a fall to castrate level.
- Therefore, requires anti-androgen cover for the first 2wk after the first injection (e.g. bicalutamide, flutamide, or cyproterone acetate).
- Similar toxicities to surgical castration, but also flushing and sweats, weight gain.
- Reversible effects, but may take many months for the testosterone level to recover after withdrawal of the LHRH agonist.
- The LHRH antagonist degarelix has been shown to provide prompt effective anti-androgen therapy without androgen blockade and may be considered in patients requiring rapid effective treatment, e.g. with advanced spinal metastasis.

#### *Androgen blockade*

- Non-steroidal agents, e.g. bicalutamide or flutamide:
  - anti-cancer effects are rather less but may preserve libido and sexual potency because of incomplete androgen blockade
  - may cause gynaecomastia.
- Steroidal—cyproterone acetate:
  - not recommended for long-term use because of toxicities (thromboembolic disease, hepatotoxicity).

#### *Maximal androgen blockade*

- Combination of surgical or medical castration plus androgen blockade
- No clear evidence of superior outcomes, compared with castration alone.

Hormonal treatment options are summarized in Table 19.9.



**Table 19.9** Hormonal treatment options for prostate cancer

First line	Second line	Third line	Fourth line
Surgical castration	Add androgen antagonist	Withdrawal of androgen antagonist	
LHRH agonist	Add androgen antagonist	Withdrawal of androgen antagonist	
Androgen antagonist	Add LHRH agonist		

After a median of 2y of androgen deprivation, patients with metastatic prostate cancer demonstrate evidence of disease progression, initially asymptomatic with rising PSA, then with symptomatic progression of the disease, most commonly painful bone metastases. These patients may be treated with second-line hormone therapy.

- The introduction of an androgen blocker, e.g. bicalutamide, in combination with surgical or medical castration, leads to PSA response in ~20%; duration of response of 2–6mo.
- Patients who respond to maximal androgen blockade and then have a PSA rise may respond again, following withdrawal of the oral anti-androgen.

#### *Castration-resistant metastatic disease*

Disease progression can still be influenced by hormonal manipulation:

- inhibition of the production of adrenal androgens by low-dose steroids or ketoconazole
- low-dose oestrogens (diethylstilbestrol 1mg daily, often with aspirin thromboprophylaxis)
- recent trials of abiraterone, an inhibitor of the enzyme CYP17A1, key to androgen biosynthesis, have shown benefit after failure of established second- and third-line treatments. The survival of patients who had already received at least second-line hormone therapy and chemotherapy with docetaxel was extended by 4mo (14.8mo versus 10.9mo) when they were treated with abiraterone and prednisolone, compared with prednisolone only. Further benefits have been shown in a trial in patients who had not received chemotherapy, with delay in disease progression and an improvement in survival
- similar benefits have been seen with enzalutamide, a novel inhibitor of androgen receptor binding.

#### *Radiotherapy and chemotherapy for metastatic disease*

Palliative EBRT has been used successfully for many to alleviate symptoms from metastatic prostate cancer.

- Painful bone metastases may be treated with low-dose radiotherapy, e.g. 8Gy/one fraction.
- Spinal cord or nerve root compression may be treated with short-course radiotherapy, e.g. 20Gy/five fractions.
- Symptomatic soft tissue disease, e.g. prostatic 1° or lymph node metastasis, may be treated with similar doses.

- Radioactive strontium, administered as a single IV injection (150MBq), provides targeted irradiation to multiple bone metastases:
  - gives pain relief and delays the need for further analgesia and radiotherapy
  - well tolerated but does cause significant myelosuppression
  - recent trials, using multiple doses of radium-223, an  $\alpha$  particle emitter, have shown not only effective dose-dependent pain relief, but also improved survival from metastatic disease.

Chemotherapy traditionally was viewed as ineffective and inappropriate for the majority of patients, due to the limited number of active agents, age and frailty of these patients, and marrow compromise by both metastatic disease and radiotherapy. Radiological assessment of the objective response to treatment can be difficult in patients with only sclerotic bone metastasis. However, chemotherapy can be of benefit:

- mitoxantrone, usually in combination with low-dose prednisolone, causes PSA response (>50% reduction in PSA) in around one-third, with accompanying symptom relief
- docetaxel has been shown to cause more frequent PSA responses and improves the median survival time by about 2mo, when compared with mitoxantrone
- carbazitaxel has shown some activity in patients who have progressed after docetaxel chemotherapy.

Bisphosphonate therapy, using monthly infusions of zoledronic acid, has also been shown to delay the symptomatic progression of bone metastases, but the optimum timing to commence bisphosphonates and the duration of therapy remain to be defined.

### **Organ-confined prostate cancer**

For patients diagnosed with early-stage prostate cancer, several treatment options may be considered. The selection of the most appropriate option depends on consideration of:

- the life expectancy of the patient, taking into account the age and co-morbidities
- the predicted natural history of the prostate cancer, determined by the stage, PSA, and Gleason score
- the patient's preferences, often with consideration of the likely toxicities of treatment.

#### *Risk stratification for localized prostate cancer*

Commonly, the disease is categorized as follows:

- Low risk                      T1–2a and PSA <10 micrograms/L and Gleason 6
- Intermediate risk        T2b–c or PSA 10–20 micrograms/L or Gleason 7
- High risk                     T3–4 or PSA >20 micrograms/L or Gleason 8–10

### Radical prostatectomy

For patients <70y, without significant co-morbidities and with low- or intermediate-risk disease, radical surgery gives excellent DFS rates. The approach may be retropubic or perineal, the former allowing pelvic lymph node sampling. Alternatively, initial lymph node sampling may be performed laparoscopically, avoiding major surgery in patients who have positive lymph nodes. Post-operative problems have been reduced with improvements in surgical technique but may include:

- urinary incontinence, rarely (~5%) persists beyond 6mo
- impotence, previously inevitable after prostatectomy, with nerve-sparing procedures may be prevented in 50%
- after prostatectomy, the PSA should fall promptly to <0.1 micrograms/L. Patients with positive resection margins may benefit from post-operative radiotherapy to the prostate bed. The role of adjuvant hormonal therapy in such patients is being explored (MRC Radiotherapy and Androgen Deprivation in Combination After Local Surgery (RADICALS) trial)
- increasingly, radical prostatectomy is being undertaken laparoscopically with excellent results. Laparoscopic radical prostatectomy in experienced hands (there is a definite learning curve) gives as good functional and oncological results as the open procedure, with more rapid recovery. The advantage for robotic prostate surgery is unclear, although a number of specialized centres have this expensive facility.

### Radical radiotherapy

For patients with low-, intermediate-, or high-risk disease, where metastatic disease has been excluded by MRI or CT scan of the pelvic and retroperitoneal lymph nodes and, where appropriate, by isotope bone scan, radical radiotherapy offers an alternative curative treatment option. There are no randomized trials comparing surgery and radiotherapy for early prostate cancer, but stage-for-stage rates of DFS after radiotherapy compare favourably with surgery. In addition, many patients treated by radiotherapy are unfit or have disease that is too extensive for surgery.

### External beam radiotherapy

High doses of ionizing radiation are required to eradicate prostate cancer. Using CT-planned conformal radiotherapy, doses of 74Gy in 37 fractions can be safely delivered to the prostate, with acceptable normal tissue reactions and a high rate of DFS. Prior treatment with 3–6mo of anti-androgen therapy reduces the prostatic volume by about 30% and is recommended in intermediate- and high-risk disease. In high-risk disease, there is now good evidence to support the continuation of adjuvant anti-androgen therapy (usually an LHRH agonist) for 2–3y after radiotherapy, with an improvement in survival at least in locally advanced disease. EBRT fields can encompass the tumour that is invading through the prostate capsule.

Common toxicities of radiotherapy to the prostate include:

- acute radiation cystitis/urethritis with urinary frequency, poor stream, and dysuria
- acute radiation proctitis with tenesmus, pain, and passage of mucus and blood
- late effects, including impotence in ~50% (and all patients receiving anti-androgen therapy) and rectal bleeding from telangiectasia.

There is evidence that irradiation of the pelvic lymph nodes, as well as the prostate gland, reduces the risk of relapse in men with intermediate- or high-risk disease. Many centres are currently using IMRT techniques to facilitate irradiation of the lymph nodes and prostate, with reduced normal tissue damage, in particular the bladder and rectum. Clinical trials are also under way to compare prolonged-course radiotherapy using 2Gy fractions with shorter hypofractionated regimens using IMRT.

### *Brachytherapy*

Permanent implantation of radioactive iodine seeds ( $^{125}\text{I}$ ) under transrectal ultrasound control may be used to deliver a dose of ~140Gy to the prostate, again with excellent results in organ-confined prostate cancer. This treatment is contraindicated in patients who have marked urinary outflow symptoms, very small or large prostate volumes, or previous transurethral resection of the prostate (TURP). It avoids the inconvenience of 7–8wk of EBRT and has similar toxicities:

- radiation urethritis—may require a urinary catheter for some days
- radiation proctitis
- impotence—probably less frequent than with EBRT.

Neoadjuvant and adjuvant hormone therapy may be used with brachytherapy, as for EBRT.

An alternative approach is to combine brachytherapy with EBRT, the former commonly delivered using a single temporary insertion of a high-dose-rate (HDR) applicator.

### *Hormone therapy alone*

Androgen deprivation has been used for many years to treat patients with localized prostate cancer if they are unfit for radical surgery or radiotherapy. However, such treatment has only a temporary impact, in terms of delay of tumour progression, and, although normal PSA levels may be maintained for a number of years, hormone-refractory disease eventually develops if patients survive many years. There is controversy surrounding the timing of hormone therapy for non-metastatic prostate cancer, particularly when this is asymptomatic. For unfit elderly patients with high-risk disease, for whom radical treatment is not appropriate or feasible, immediate treatment with androgen deprivation may be preferred to watchful waiting.

### *Active surveillance*

Particularly for patients aged >70y with low-risk cancers, a policy of expectant management is appropriate. The Scandinavian Prostate Cancer Group has recently published 10y results of their randomized study of watchful waiting versus radical prostatectomy. This study clearly demonstrates benefits of radical treatment for prostate cancer, in terms of reduction in the risk of local recurrence, metastatic disease, the need for hormone therapy, and death from prostate cancer. However, these benefits appear to be in patients who are <65y, often with intermediate-risk disease.

Active surveillance is recommended for patients with low-volume and low-grade prostate cancer (T1–T2, <50% core biopsy-positive, Gleason 6 carcinoma, and PSA <15ng/mL). Protocols which aim to minimize the risks of missing disease progression during active surveillance include regular PSA estimation, clinical assessment, and repeat prostate biopsies every 2y. In

addition, many clinicians repeat MRI imaging every 2y. Patients who develop progressive disease (rising PSA, clinical evidence of disease progression, or worsening grade on repeat biopsy) during active surveillance should be considered for radical treatment.

#### *Prostate-specific antigen failure*

A rising PSA level after radical prostatectomy or radical radiotherapy may herald the development of local recurrence or metastatic disease. Predictors of the latter are:

- a short interval from treatment to PSA rise
- PSA doubling time <6mo
- involved surgical margins, pelvic lymph nodes, or seminal vesicles at prostatectomy.

Patients with features suggesting local recurrence after surgery may be candidates for radiotherapy. Rising PSA after radiotherapy may be managed expectantly, or with androgen deprivation, or with salvage local therapy, e.g. prostate cryotherapy. There is controversy surrounding the benefits, morbidities, and timing of these interventions.

#### **Treatment outcomes**

The prognosis of early prostate cancer is excellent, with median survival times >10y for patients treated by either radical prostatectomy or radiotherapy. Active surveillance appears safe in low-risk patients, 70% of whom remain well and free of treatment after 5y. Reassuringly, the number of deaths from prostate cancer in the US is falling. Although disease progression, as measured by rising PSA, occurs in around 40% of surgical patients and ~50% of patients treated by radiotherapy, the natural history of recurrent disease may be very slow. US data have shown that the median time from PSA rise post-prostatectomy to the development of metastatic disease may be as long as 8y. The median time from PSA rise after radical radiotherapy, until metastatic disease is shorter, around 5y, almost certainly reflecting the more advanced stages of disease treated with this modality.

For metastatic disease, the median duration of response to hormone therapy is 18–24mo. The median survival time after development of hormone-refractory disease is 12–18mo.

## Testicular cancer

The treatment of advanced testicular cancer represents one of the great successes of medical oncology in the last 40y. This is one of the few solid tumours for which the majority of patients with metastatic disease can expect to be cured. Efforts are now focusing on minimizing the late effects of curative therapy, as well as improving the outlook for poor-prognosis advanced disease.

### Epidemiology and aetiology

Ninety-five per cent of testicular tumours are of germ cell origin. These are relatively uncommon malignancies, around 2200 cases in the UK each year, the fourteenth commonest cancer in men overall. They are, however, the commonest cancer in men aged 20–40y, and their incidence has doubled over the last 30y. The reason for this increase is not clear.

The age distribution is dependent on the pathology.

- Seminoma is the most frequent pathology (55%):
  - peak incidence age 30–40y
  - occasionally 60–70y.
- Non-seminoma (45%):
  - includes tumours with mixed seminoma and non-seminoma
  - peak incidence age 20–30y.

An increased risk of testicular cancer is observed in men with:

- a history of undescended testis (relative risk 8 times)
- previous testicular cancer (relative risk 25 times)
- testicular CIS
- a family history of testicular cancer
- Klinefelter's syndrome
- an atrophic testis and infertility
- *in utero* exposure to oestrogens.

It is believed that both environmental and genetic factors combine to give rise to testicular dysgenesis, manifested as either Leydig cell malfunction, with failure of normal testicular descent, or impaired germ cell differentiation with poor sperm production and/or malignant change.

### Screening

There is no evidence to support population screening for this disease.

### Genetics

Testicular germ cell tumours are invariably aneuploid. Gain of the 12p chromosome arm, most commonly as an isochromosome, is highly consistent.

### Pathology

Germ cell tumours arise from the germinal epithelium, and both seminomas and non-seminomatous germ cell tumours (NSGCTs) are thought to arise from pre-existing CIS. The British classification has been replaced by the WHO system (see Table 19.10).

The natural histories of seminomas and NSGCTs differ, and these differences dictate the variation in management between the two pathologies. The majority of seminomas (75%) present with disease confined to the

Table 19.10 Pathological classification of testicular cancers

British	WHO	Relative frequency (%)
Seminoma	Seminoma	55
Teratoma	NSGCT	33
Mixed seminoma teratoma	Mixed germ cell tumour	12
Teratoma differentiated (TD)	Mature teratoma	
Malignant teratoma intermediate (MTI)	Embryonal carcinoma with teratoma (teratocarcinoma)	
Malignant teratoma undifferentiated (MTU)	Yolk sac tumour, embryonal carcinoma	
Malignant teratoma trophoblastic (MTT)	Yolk sac tumour; choriocarcinoma	

testis. Spread tends to be predictable—to the para-aortic lymph nodes in the first instance and subsequently to the supradiaphragmatic lymph nodes, and then to other metastatic sites. Tumour growth can be very slow, so that untreated microscopic metastatic disease may take up to 10y to become clinically apparent.

In contrast, only 50% of testicular NSGCTs present with localized disease. Blood-borne and lymphatic spread occurs earlier than with seminomas. The behaviour of mixed testicular germ cell tumours is dominated by the NSGCT component.

### Tumour markers

NSGCTs produce serum markers in the form of human chorionic gonadotrophin (HCG) and/or AFP in 75% of cases. Seminomas, on the other hand, have no reliable tumour marker to monitor disease, although HCG may be moderately elevated in about 25% of cases. LDH may be raised in both tumours and is useful for defining a prognostic group, correlating with the tumour bulk, but it is not a reliable marker for monitoring the response to treatment or subsequent relapse.

### Presentation

Most commonly presents with a hard testicular lump, which may be painless or be mistaken for epididymo-orchitis. Patients with testicular symptoms that persist, despite one course of antibiotics, should be referred to a urology clinic for assessment, including ultrasound examination of the testes.

Men with tumours producing high levels of HCG may develop gynaecomastia which resolves with treatment of the cancer.

Metastatic disease may present with:

- lumbar back pain associated with bulky (>5cm) para-aortic lymphadenopathy
- cough and dyspnoea with multiple lung metastases
- SVCO with mediastinal lymphadenopathy
- CNS symptoms/signs with brain metastasis.

Many patients with relapsed disease are diagnosed with asymptomatic spread of disease, picked up on routine monitoring of serum markers, CXR, or CT scan.

### **Investigation of testicular germ cell tumours**

This initially includes:

- USS of both testes
- CXR
- tumour markers (AFP, HCG, LDH).

Where the patient has obvious and widespread metastases, immediate referral for chemotherapy may be necessary, but, for the majority, the initial management will be inguinal orchidectomy. A biopsy of the contralateral testis should be considered where there is a high risk of CIS. Patients at risk include those with a history of maldescent, a small testis (<12mL), and patients aged <30y. Further staging investigations will usually be performed post-operatively.

#### *Staging investigations and prognostic grouping*

Staging investigations will include, in all patients, a CT scan of the thorax, abdomen, and pelvis. In patients with greatly elevated HCG (>10 000IU/L) or bulky mediastinal disease or symptoms/signs of CNS disease, a CT scan of the brain is advisable. Post-orchidectomy tumour markers should be serially checked, if raised, to assess whether or not they are falling with an appropriate half-life (4–6 days for AFP, 24h for HCG). Other investigations, such as an isotope bone scan, may be necessary, if clinically indicated.

Staging of the 1<sup>o</sup> tumour post-orchidectomy is according to the TNM system. Until recently, the Royal Marsden Hospital (RMH) staging (see  <https://cancerstaging.org> to download the TNM staging) has been used for both NSGCTs and seminomas. The International Germ Cell Consensus Classification (IGCCC) prognostic grouping (see Table 19.12) is now applicable for all patients with stage >I disease.

#### *Sperm storage*

Sperm count and storage should be considered at an early stage where patients are likely to require further therapy. It should be remembered that up to 50% of patients with testicular germ cell tumour may be subfertile at presentation.





## Management of testicular cancer

The management of seminomas and NSGCTs depends on the stage of disease and involves all three major modalities for the treatment of cancer—surgery, radiotherapy, and chemotherapy (see Table 19.11).

### **Carcinoma *in situ***

Germ cell CIS may progress to invasive cancer, either seminoma or NSGCT, with 50% producing invasive tumours 5y from diagnosis. Once this diagnosis is made, treatment should be offered, although this may not need to be given immediately. CIS can be eradicated by low-dose radiotherapy to the testis (20Gy in ten fractions). The advantage of this treatment is that, in the majority of cases, it will avoid orchidectomy and not affect Leydig cell function, and long-term hormone therapy should not be necessary.

### **Stage I seminoma**

Orchidectomy must be radical, and the incision must be in the groin to avoid tumour seeding in the scrotal skin.

Despite a negative staging on CT scan, 20% of these patients develop recurrent seminoma after orchidectomy; 90% of relapses are in para-aortic nodes, but some of these are late, up to 10y after orchidectomy. Relapse is commoner after orchidectomy for testicular tumours of >4cm in diameter but is usually marker-negative and only detectable on CT scan. The prognosis is excellent—almost all patients with relapsed disease are cured by salvage therapy (see ↻ Stages IIc–IV seminoma and stages IM–IV non-seminomatous germ cell tumour, p. 439).

Currently, there are three management options for patients with stage I seminoma:

- adjuvant radiotherapy to the para-aortic nodes, T11–L5 (20Gy in ten fractions):
  - reduces the relapse rate to 4%
  - well tolerated, but significant risk of radiation-induced abdominal malignancy
- surveillance, including annual CT (or MRI scan within the MRC TRISST study) of the abdomen and pelvis
- adjuvant chemotherapy with one cycle of carboplatin chemotherapy:
  - recent results suggest a similar reduction in the relapse rate as with radiotherapy to retroperitoneal lymph nodes.

### **Stages IIA and IIB seminoma**

These patients are best treated with radiotherapy to the para-aortic and ipsilateral iliac lymph nodes.

- IIA—30Gy in 15 fractions leads to 95% DFS after 5y.
- IIB—36Gy in 18 fractions leads to 90% DFS after 5y.

**Table 19.11** Examples of chemotherapy regimens for testicular cancer

BEP			
Bleomycin	30mg	Days 1, 8, 15	q 3wk
Etoposide	100mg/m <sup>2</sup>	Days 1–5	
Cisplatin	20mg/m <sup>2</sup>	Days 1–5	
EP			
Etoposide	100mg/m <sup>2</sup>	Days 1–5	q 3wk
Cisplatin	20mg/m <sup>2</sup>	Days 1–5	
VIP			
Etoposide	75mg/m <sup>2</sup>	Days 1–5	q 3wk
Ifosfamide	1.2g/m <sup>2</sup>	Days 1–5	
Cisplatin	20mg/m <sup>2</sup>	Days 1–5	

### Stage I non-seminomatous germ cell tumour

After orchidectomy alone, the relapse rate is around 30%, with the majority of relapses occurring in the first 2y and many detected by a rise in tumour markers, with only low-volume disease in the para-aortic nodes or lungs. As a result, the outcome of treatment for relapsed stage I disease is excellent, with cure rates of >95%. The best predictor of relapse is the presence of vascular invasion in the tumour—50% of these men develop metastatic disease if given no adjuvant therapy.

The treatment options are:

- surveillance, including frequent clinic visits, CXR, tumour marker monitoring, and regular CT scans, particularly in the first 2y
- adjuvant chemotherapy, particularly for tumours with vascular invasion:
  - two cycles of BEP (bleomycin, etoposide, cisplatin) chemotherapy
  - 97% DFS
- nerve-sparing retroperitoneal lymph node dissection with adjuvant chemotherapy for node-positive disease:
  - not commonly used in the UK.

Each of these results in >95% long-term DFS.

- In the US, there is a more aggressive surgical approach to the resection of retroperitoneal nodes for stage I NSGCTs.

### Stages IIc–IV seminoma and stages IM–IV non-seminomatous germ cell tumour

Chemotherapy is the mainstay of treatment for all these stages of testicular cancer and has been the key to the improvement in prognosis for this disease over the last 20y. For the vast majority of patients, treatment is based on the BEP regimen. All patients should be assigned an IGCCC prognostic group to guide treatment (see Table 19.12).

#### Good-prognosis disease

Standard treatment comprises three cycles of BEP chemotherapy, monitoring of tumour markers weekly, and re-staging by CT scan at the end of chemotherapy. In patients in whom bleomycin is unsafe (older patients with

poor lung function), an alternative regimen, with equivalent results, is four cycles of EP chemotherapy.

The toxicities of BEP chemotherapy include:

- nausea and vomiting (largely prevented with appropriate anti-emetics, including a 5-HT<sub>3</sub> antagonist and dexamethasone)
- neutropenic sepsis:
  - dose delays and reductions should be avoided
  - G-CSF may be used as 2° prophylaxis after one episode of neutropenic sepsis
- neuropathy:
  - cisplatin causes sensory peripheral neuropathy and high-tone hearing loss
  - toxicity is reduced when cisplatin dose fractionated over 5 days
- nephropathy:
  - cisplatin causes a fall in the glomerular filtration rate (GFR) and tubular damage, often associated with hypomagnesaemia
  - best managed by prevention (pre- and post-hydration, diuretic, e.g. furosemide and mannitol, IV magnesium supplements)
- pulmonary fibrosis:
  - the risk relates to the cumulative dose of bleomycin
  - this toxicity can be fatal.

#### *Residual tumour masses post-chemotherapy*

After completion of chemotherapy, CT scan may show persistent masses at the site of the original metastatic disease. For patients with seminoma, such masses are managed expectantly, and the majority are seen to slowly regress on serial scans. Alternatively, FDG-PET scanning can be helpful in the early detection of residual active tumour. However, for patients with NSGCT, in whom residual tumour is apparent, surgical resection should be performed. The majority of these will be in the retroperitoneum, and extensive and difficult surgery is often necessary for a complete resection. The assistance of a vascular surgeon is required not infrequently. Morbidity can be up to 10%, and mortality 0.5%. The residual masses may contain:

- necrotic tumour (50%)
- mature teratoma (35%); although histologically benign, excision is important, as this tissue can give rise to malignancy, if left *in situ*
- viable tumour (15%); may require additional chemotherapy.

Surgery should usually only be undertaken when markers have normalized. Residual pulmonary masses should also be resected, where possible. The problems of surgical technique and anaesthetic risk, particularly as most patients will have been exposed to bleomycin, demand that patients are operated on in a centre experienced in this surgery.

Retroperitoneal node dissection can be performed laparoscopically in experienced centres.

#### *Intermediate- and poor-prognosis disease*

Although no chemotherapy regimen has yet been proven to be superior to four cycles of BEP chemotherapy for these groups of patients, the outcomes of treatment are significantly poorer, with 5y survival:

- intermediate group—80%
- poor group—71%.

All such patients should be considered for clinical trials exploring novel or more intensive treatment options.

### Follow-up

Following 1° management of metastatic disease, regular follow-up is necessary as, in those patients who relapse, salvage therapy can be effective in ~25% of cases.

### Non-germ cell testicular tumours

These represent a very small proportion of testicular tumours. Stromal tumours, such as those arising from Leydig cells, are generally benign, but metastases have been reported in ~10% of cases. Testicular lymphomas are the commonest testicular cancer in elderly men and should be treated along the same principles as lymphomas arising at other sites.

**Table 19.12 IGCCC prognostic grouping for metastatic germ cell tumours**

Teratoma (NSGCT)	Seminoma
<b>Good prognosis with all of:</b>	
Testis/retroperitoneal 1°	Any 1° site
No non-pulmonary visceral metastases	No non-pulmonary visceral metastases
AFP <1000ng/mL	Normal AFP
HCG <5000IU/mL	Any HCG
LDH 1.5 × the upper limit of normal	Any LDH
56% of teratomas: 5y survival 92%	90% of seminomas: 5y survival 86%
<b>Intermediate prognosis with any of:</b>	
Testis/retroperitoneal 1°	Any 1° site
No non-pulmonary visceral metastases	Non-pulmonary visceral metastases
AFP >1000 and <10 000ng/mL	Normal AFP
HCG >5000 and <50 000IU/mL	Any HCG
LDH >1.5 × normal <10 × normal	Any LDH
28% of teratomas: 5y survival 80%	10% of seminomas: 5y survival 73%
<b>Poor prognosis with any of:</b>	
Mediastinal 1°	No patients in this group
Non-pulmonary visceral metastases	
AFP >10 000ng/mL	
HCG >50 000IU/mL	
LDH >10 × normal	
16% of teratomas: 5y survival 71%	

## Penile cancer

### Epidemiology

This is an uncommon cancer, with around 350 new cases per annum in the UK. The majority occur in the over 70s, but up to 20% occur under the age of 40y. The disease is relatively commoner in Africa, India, and South America.

### Aetiology

- HPV 16 and 18 infections.
- Associated with poor hygiene and phimosis.
- Pre-malignant lesion—CIS:
  - on the glans—erythroplasia of Queyrat
  - on the shaft—Bowen's disease
  - progresses to invasive carcinoma in ~10%.
- Increased risk with cigarette smoking and immunosuppression, including HIV infection.
- Neonatal circumcision gives lifelong protection.

### Pathology

The vast majority are squamous carcinomas, which may be exophytic or locally invasive and destructive, and can spread initially via the lymphatics to the inguinal, and then pelvic, lymph nodes. Locally advanced disease can spread to other organs, including the liver, lungs, bone, and skin.

### Staging

The TNM system is commonly used (see  <https://cancerstaging.org> to download the TNM staging).

### Investigations

- Careful examination of the penis with, cytological assessment or biopsy of any lesion.
- General examination, including palpation of the inguinal lymph nodes.
- >50% have inguinal lymphadenopathy, but less than half of these have metastatic disease within the nodes—reactive lymphadenopathy is commoner.
- FNA for suspicious lymph nodes, or review lymph nodes after treatment of the 1° carcinoma.
- Further staging, e.g. cross-sectional imaging of the abdomen and pelvis, is only required if inguinal nodes involved or clinical suspicion of metastatic disease.

### Presentation

At least 50% arise on the glans, appearing as an area of erythema, warty tumour, or ulceration; 20% involve the foreskin only. In advanced disease, there may be considerable destruction of the penis. Patients not uncommonly conceal the diagnosis, until there is advanced loco-regional disease with considerable 2° infection. Patients may present with metastatic disease, e.g. inguinal and pelvic lymphadenopathy.

## Management

### *Primary tumour*

Early-stage disease may be successfully managed with organ conservation:

- Tis—topical fluorouracil, laser therapy, cryotherapy, local excision
- T1—excision or radiotherapy.

More advanced disease or local recurrence often requires at least partial amputation of the penis. Patients with inoperable disease may be treated with chemotherapy and radiotherapy.

### *Regional lymph nodes*

Inguinal lymph nodes may be managed by surveillance, if impalpable, after completion of local treatment to the 1°. However, with high-grade T2 and more advanced cancers, the incidence of positive regional lymph nodes is 60% or higher, and elective bilateral inguinal lymphadenectomy should be considered in the absence of clinical involvement of lymph nodes. Patients with persistent lymphadenopathy, after clearance of the 1° tumour and any infection, should be considered for bilateral inguinal lymphadenectomy. Patients who are unfit for surgery or have inoperable disease may benefit from chemotherapy and radiotherapy. The role of SLNB is unclear, and it is not in widespread use.

The disease is moderately chemosensitive, and active regimens include MTX, bleomycin, and cisplatin (MBP). Chemotherapy is recommended both for advanced disease and as adjuvant therapy for node-positive disease.

## Outcomes

Overall, 50% survive disease-free beyond 5y, with better results in node-negative (60%), compared with node-positive (30%), disease. The majority of relapses occur in the first 2y, and close follow-up is recommended at least during this time.

## Further reading

### Bladder cancer

- Advanced Bladder Cancer Meta-analysis Collaboration (2003). Neoadjuvant chemotherapy in invasive bladder cancer: a systematic review and meta-analysis. *Lancet* **361**, 1927–34.
- Cookson MS, Herr HW, Zhang ZF, Soloway S, Sogani PC, Fair WR (1997). The treated natural history of high risk superficial bladder cancer: 15-year outcome. *J Urol* **158**, 62–7.
- Horikawa Y, Kamazawa T, Narita S, et al. (2007). Lymphatic invasion is a prognostic factor for bladder cancer treated with radical cystectomy. *Int J Clin Oncol* **12**, 131–6.
- James ND, Hussain SA, Hall E (2012). Radiotherapy with or without chemotherapy in muscle invasive bladder cancer. *N Engl J Med* **366**, 1477–88.
- Raghavan D, Shipley WU, Garnick MB, Russell PJ, Richie JP (1990). Biology and management of bladder cancer. *N Engl J Med* **322**, 1129–38.
- Scottish Intercollegiate Guidelines Network (2005). *Management of transitional cell carcinoma of the bladder: a national clinical guideline. Guideline 85*. Edinburgh: Scottish Intercollegiate Guidelines Network. Available at: <http://www.sign.ac.uk/pdf/sign85.pdf> (accessed 18 December 2012).

### Penile cancer

- Hungerhuber E, Schlenker B, Frimberger D (2006). Lymphoscintigraphy in penile cancer: limited value of sentinel node biopsy in patients with clinically suspicious nodes. *World J Urol* **24**, 319–24.

### Prostate cancer

- Loblaw DA, Virgo KS, Nam R, et al.; American Society of Clinical Oncology (2007). Update of a practice guideline: initial hormonal management of androgen-sensitive metastatic, recurrent, or progressive prostate cancer. *Clin Oncol* **25**, 1596–605.
- Barry MJ (2008). Screening for prostate cancer among men 75 years of age or older. *N Engl J Med* **359**, 2515–16.
- Damber JE, Aus G (2008). Prostate cancer. *Lancet* **371**, 1710–21.
- Frankel S, Smith GD, Donovan J, Neal D (2003). Screening for prostate cancer. *Lancet* **361**, 1122–8.
- Graham J, Baker M, Macbeth F, Titshall V; Guideline Development Group (2008). Diagnosis and treatment of prostate cancer: summary of NICE guidance. *BMJ* **336**, 610–12.
- Jani AB, Hellman S (2003). Early prostate cancer: clinical decision-making. *Lancet* **361**, 1045–53.
- National Institute for Health and Care Excellence (2008). *Prostate cancer: diagnosis and treatment. Clinical guideline 58*. London: National Institute for Health and Care Excellence. Available at: <http://www.nice.org.uk/guidance/cg58>.

### Renal cancer

- Atzpodien J, Kirchner H, Jonas U, et al. (2004). Interleukin-2- and interferon alfa-2a-based immunotherapy in advanced renal cell carcinoma: a Prospectively Randomized Trial of the German Cooperative Renal Carcinoma Chemoimmunotherapy Group (DGCIN). *J Clin Oncol* **22**, 1188–94.
- Coppin C, Kollmannsberger C, Le L, Porzolt F, Wilt TJ (2011). Targeted therapy for advanced renal cell cancer (RCC): a Cochrane systematic review of published randomized trials. *BJU Int* **108**, 1556–63.
- Dehn T (2008). Management of renal cell carcinoma. *Ann R Coll Surg Engl* **90**, 278–81.
- Medical Research Council Renal Cancer Collaborators (1999). Interferon-alpha and survival in metastatic renal carcinoma: early results of a randomized controlled trial. *Lancet* **353**, 14–17.
- Ogan K, Cadeddu JA, Stifelman MD (2003). Laparoscopic radical nephrectomy: oncologic efficacy. *Urol Clin North Am* **30**, 543–50.
- Rini BI, Small EJ (2005). Biology and clinical development of vascular endothelial growth factor targeted therapy in renal cell carcinoma. *J Clin Oncol* **23**, 1028–43.
- Tomita Y (2006). Early renal cell cancer. *Int J Clin Oncol* **11**, 22–7.
- Volpe A, Panzarella T, Rendon RA (2004). The natural history of incidentally detected small renal masses. *Cancer* **100**, 738–45.

### Testicular cancer

- Christoph F, Weikert S, Miller K, Schrader M (2005). New guidelines for clinical stage I testicular seminoma? *Oncology* **69**, 455–62.
- Scottish Intercollegiate Guidelines Network (1998). *Management of adult testicular germ cell tumours: a national clinical guideline. Guideline 124*. Edinburgh: Scottish Intercollegiate Guidelines Network. Available at: <http://www.sign.ac.uk/pdf/sign124.pdf>.



# Gynaecological cancers

- Ovarian cancer 446
- Cancer of the uterine corpus 450
- Cancer of the cervix 454
- Vaginal and vulval cancer 458
- Trophoblastic tumours 460
- Further reading 465

## Ovarian cancer

- Fifth commonest cancer in women, with over 6000 cases diagnosed and over 4000 women dying of the disease each year in the UK. Incidence slowly rising.
- The majority of cases occur over the age of 55y, with the peak in the 65–75y age group.

### Aetiology

- The risk of ovarian cancer relates to the number of ovulatory cycles in a woman's lifetime and multiple pregnancies.
- Use of the oral contraceptive pill now shown to offer protection; infertility or its treatment may increase the risk.
- About 5% are clearly hereditary—associated with *BRCA1* or *BRCA2* or Lynch families (see Chapter 14).

### Pathology

- 80% of ovarian malignancies are epithelial. Serous and endometrioid cancers are the commonest forms, but about 5% are mucinous or clear cell. Clear cell cancers account for up to 20% in the Far East.
- The rest comprises germ cell, sex cord/stromal tumours, sarcomas, and neuroendocrine cancers.

### CA125

Eighty per cent of women with advanced ovarian cancer have elevated serum CA125, and this marker is valuable in monitoring the response to therapy and in the detection of early relapse. However, it is not specific for ovarian cancer and is elevated in association with other peritoneal pathologies. A ratio of CA125 and CEA that is higher than 25 may help to support the diagnosis of epithelial ovarian cancer (EOC).

### Presentation and staging

- The majority of women present with disease that has spread beyond the ovary to involve the peritoneum and other abdomino-pelvic organs.
- The commonest symptoms are abdominal discomfort and swelling, bloating, and change in bowel habit.
- GI and urinary symptoms also occur.

The two main prognostic factors in ovarian cancer are the stage (see Table 20.1) and the amount of residual disease after surgery. The 5y survival rates, according to the stage, are as follows:

- stage I, 80%; but over 90% for stage IA
- stage II, 45%
- stage III, 20%
- stage IV, <10%.

**Table 20.1** A simplified staging of ovarian cancer

Stage	Description
Ia	Tumour confined to one ovary
Ib	Tumour confined to both ovaries
Ic	Tumour stage I, but with capsule ruptured or malignant ascites
II	Tumour with pelvic extension only
III	Tumour with peritoneal implantation outwith the pelvis or involved small bowel; retroperitoneal or inguinal nodes
IV	Distant metastases, e.g. intrahepatic, pleura, or lung

### Treatment of epithelial ovarian cancer

- The 1° treatment remains surgery, with the aim to achieve complete surgical removal or maximal debulking effort.
- This should also include thorough staging, with removal of the omentum, peritoneal washings, inspection of the subdiaphragmatic areas, and, more controversially, lymphadenectomy.
- The amount of residual disease correlates with worse prognosis.
- The majority of patients present with advanced disease (stages II–IV), with a correspondingly poor prognosis.
- Patients who have >2cm of disease after their initial surgery have a poor prognosis, with only 20% of patients surviving 3y.
- The median survival times for patients with suboptimally debulked disease (>1cm) range from 16 to 29mo, and from 26 to 96mo for patients with optimally debulked disease.

### Surgery

Patients must undergo full surgical staging. A surgical staging procedure consists of:

- a midline incision
- total abdominal hysterectomy
- bilateral salpingo-oophorectomy (BSO)
- omentectomy
- multiple peritoneal biopsies and washings
- lymph node sampling of the para-aortic and pelvic regions
- careful assessment of the subdiaphragmatic areas.

The case should be discussed at the local tumour board or MDT meeting. There is good evidence to support referral for surgery to a specialized gynaecological oncology surgeon.

Radical surgery plays an important role in the treatment of ovarian cancer.

A randomized trial has shown that, for patients who cannot be optimally debulked at initial laparotomy, interval debulking surgery, after three cycles of chemotherapy, confers a significant survival benefit. However, this is only applicable when the original surgery was performed by a non-specialist gynaecological oncology surgeon.

For patients who are not fit or who have supra-omental stage III disease and some stage IV patients with positive pleural effusions only, and where optimal debulking cannot be achieved, neoadjuvant chemotherapy and delayed 1° surgery may be considered as an alternative.

Laparoscopic surgery is becoming established and is especially helpful for lymph node dissection of the pelvic side wall. Over the past decade, in specialized referral centres, laparoscopic ovarian radical surgery is being assessed, with less morbidity, faster recovery, and equal oncological results to open surgery. The procedure is technically difficult; often specialists work in pairs.

### **First-line chemotherapy**

Chemotherapy is usually offered to all patients, except possibly stage Ia G1. Platinum and a taxane are usually standard, but there is a body of opinion which recommends carboplatin alone, based on the ICON 3 (International Collaborative Ovarian Neoplasm) trial, reserving taxanes for relapse.

- Platinum-based therapy is usual—carboplatin is equivalent to cisplatin, but with less toxicity.
- Taxanes are usually given in combination in most centres.
- In older or unfit patients, single-agent carboplatin is used.
- To date, the addition of a third drug or alternating doublets has failed to improve survival.
- Maintenance treatments have also failed to show survival benefit as yet.
- Intraperitoneal chemotherapy in optimally debulked patients has been shown to improve survival in four randomized trials but has been slow to be adopted universally because of toxicity and inconvenience.
- Currently, there are many trials investigating the addition of targeted anti-cancer treatments, but their exact role remains to be defined, until these trials are complete; at the time of writing, the VEGF receptor antagonists seem to offer the greatest potential.

### **Treatment at relapse**

- Patients who relapse after first-line therapy are incurable.
- The majority of patients relapse within 15–24mo, and the length of the treatment-free interval before relapse is an important factor in predicting the response to second-line therapy.
- Patients who relapse on treatment are termed platinum-refractory and should be entered into clinical trials of new agents or treated with new drugs or non-platinum-containing regimens such as pegylated liposomal doxorubicin or topotecan.
- Patients who relapse within 6mo are termed platinum-resistant, and retreatment with platinum produces response rates of <10% so should be treated as above.
- Patients with a treatment-free interval of >12mo are generally termed platinum-sensitive and should be re-challenged with a platinum-containing regimen. Other indicators of response are the bulk of disease, serous pathology, previous response to treatment, and the number of disease sites.
- A number of new agents have been licensed in this setting in recent years.

- Dose-dense and dose-intense regimes are active in these settings, and, following initial reports of cisplatin and etoposide, weekly carboplatin and paclitaxel are becoming established alternatives; 40–50% response rates are reported.

### Follow-up

Clinical dilemmas arise after first-line therapy—what follow-up protocol is appropriate and when should second-line therapy be instituted? All patients usually have serial CA125 estimations, but, as soon as the marker rises, much anxiety is caused, and many patients expect treatment. The OV05 trial may help to answer whether early intervention treatment with a rising CA125 improves outcome. Data are expected in 2009.

### Treatment of rare ovarian cancers

- Special consideration should be given to mucinous tumours which respond less well to carboplatin and paclitaxel. Investigation of regimes being used to treat GI tumours is being undertaken.
- Similarly, clear cell tumours have a worse prognosis, and Japanese experience suggests novel regimes should be tested.
- 1° ovarian sarcomas are believed to behave more aggressively, although recent experience suggests carboplatin and paclitaxel, with or without an anthracycline, should be considered.
- Small-cell cancers are often lethal and may be associated with hypercalcaemia. They tend to be more common in younger age groups. Aggressive treatment programmes are offered, but, even so, only 20–30% survive 2y.
- Germ cell tumours usually carry an excellent prognosis, and fertility-sparing surgery is advised, with the use of BEP chemotherapy in stage Ic and above. Early disease is treated more conservatively.
- Sex cord and stromal tumours may behave variably, sometimes with delayed relapse.
- All of these rare and uncommon cancers are best managed by centralized teams.

## Cancer of the uterine corpus

- Carcinoma of the endometrium accounts for over 90% of tumours.
- Less common are the uterine sarcomas. Carcinosarcomas are almost certainly poor prognostic carcinomas, but endometrial stromal sarcomas and smooth muscle tumours (leiomyosarcomas) may account for 3–8%.

### Endometrial adenocarcinoma

#### *Epidemiology and aetiology*

- Occurs principally in post-menopausal women, and the incidence rises with age.
- The aetiology has not been fully determined; however, obesity and unopposed oestrogen as HRT are thought to increase the risk.
- Women with breast cancer taking tamoxifen, which exerts oestrogenic agonist effects on the endometrium, have an increased risk of polyps, hyperplasia, and sometimes carcinoma.
- Commoner in obese women, in whom oestrogen is peripherally produced in fat.
- Lynch syndrome leads to 40–60% additional risk of endometrial cancer.

#### *Pathology*

- Two types of endometrial cancer are usually recognized—types 1 and 2.
- Type 1 is usually endometrioid and occurs in younger women with obesity and excess oestrogen exposure and generally carries a better prognosis.
- Type 2 occurs in older women with serous, clear cell, or other variants and has a more aggressive pattern. Carcinosarcomas may be associated with this type. The prognosis is usually much worse.
- The major prognostic factors are the depth of invasion of the myometrium (if >50%) and grade of the tumour (G3), and this is reflected in the International Federation of Gynecology and Obstetrics (FIGO) staging classification (see Table 20.2). This is due to be revised in 2009.
- Surgery should include total hysterectomy, BSO, and washings. Whilst many gynaecological oncologists argue for pelvic lymphadenectomy, two randomized trials have not shown any survival advantage, but there may be prognostic value from staging and help in planning adjuvant therapies.
- The ovaries are also removed, because they are frequently the site of 2° deposits or synchronous tumours.
- If the cervix is known to be involved preoperatively, an extended or radical hysterectomy should be performed.

Table 20.2 Carcinoma of the corpus uteri (FIGO, 2008)

Stage I*	Tumour confined to the corpus uteri
IA*	No, or less than half, myometrial invasion
IB*	More than half myometrial invasion
Stage II*	Tumour invades the cervical stroma but does not extend beyond the uterus**
Stage III*	Local and/or regional spread of the tumour
IIIA*	Tumour invades the serosa of the corpus uteri and/or adnexae#
IIIB*	Vaginal and/or parametrial involvement#
IIIC*	Metastases to pelvic and/or para-aortic lymph nodes#
IIIC <sub>1</sub> *	Positive pelvic nodes
IIIC <sub>2</sub> *	Positive para-aortic lymph nodes, with or without positive pelvic lymph nodes
Stage IV*	Tumour invades the bladder and/or bowel mucosa, and/or distant metastases
IVA*	Tumour invasion of the bladder and/or bowel mucosa
IVB*	Distant metastases, including intra-abdominal metastases and/or inguinal lymph nodes

\* Either G1, G2, or G3.

\*\* Endocervical glandular involvement only should be considered as stage I, and no more as stage II.

# Positive cytology has to be reported separately without changing the stage.

### Management

The mainstay of treatment for stage I disease is total hysterectomy, BSO, and peritoneal washings. Whilst not recommended routinely, pelvic (and para-aortic) lymphadenectomy should be considered in high-risk cases such as clear cell and serous carcinomas and carcinosarcomas.

The laparoscopic-assisted procedure is now being evaluated in a number of centres. The role of routine pelvic nodal dissection has not been supported in recent clinical trials (Hockel and Dornhofer, 2009).

### Radiotherapy

- Adjuvant radiation post-operatively reduces the risk of local relapse. However, none of the radiotherapy studies has shown any survival benefit in low- or intermediate-risk disease. The place of adjuvant radiotherapy is undergoing re-evaluation and should probably be reserved for cases with stage 1C and grade 3; doses given are usually between 45 and 52Gy in 25–28 fractions. Vaginal brachytherapy only may be considered as an option for intermediate-risk stage 1 patients. Brachytherapy is usually advised when there is cervical extension. Increasing evidence supports the use of sequential chemotherapy and radiation in high-risk stages 1 and 2 cancers.

- In stage 3 cancers, chemotherapy and tailored radiation are advised; discuss at the tumour board/MDT.
- A recent trial has demonstrated that neoadjuvant chemotherapy and delayed 1° surgery should be considered in selected cases.
- Less commonly, radiation may be required as 1° treatment for women unfit to undergo surgery, usually through a combination of co-morbidity and marked obesity. Cure rates are only about 50–60%.

### *Chemotherapy*

Recent studies have shown that combined chemotherapy and radiation in high-risk stage I cancers can reduce the risk of local recurrence and improve OS. Whilst traditionally doxorubicin and cisplatin were used, this is being replaced, as the community standard, by carboplatin and paclitaxel.

### *Prognosis*

- Best survival rate of the gynaecological cancers.
- Overall 5y survival of 70–75%.
- Low-risk stage I disease carries a 15y survival in excess of 90%.
- High-risk stage I disease nearer 50%.
- In stages II, III, and IV disease, the 5y survival falls to 50%, 30%, and 10%, respectively.

### **Sarcomas**

The classification of sarcomas has recently been reviewed. Most experts now consider carcinosarcomas (previously known as MMMT—malignant mixed mesodermal tumours) as poorly differentiated carcinomas. Molecular markers support this. Uterine sarcomas are now divided into high-grade and low-grade, but many clinicians still refer to stromal sarcomas and leiomyosarcomas. They have different patterns of behaviour and spread. Nodal metastases are commoner with carcinosarcomas and stromal sarcomas, but leiomyosarcomas tend to spread haematogenously, so lung and liver metastases are common, and CT scanning is advised for staging.

Successful treatment depends very much on surgery for localized disease. Debulking is helpful for extensive disease. Residual disease or tumours with nodal or distant metastases are usually incurable. Hysterectomy and BSO should be performed, together with pelvic lymphadenectomy to stage the disease. Residual disease can be treated with radiation. Adjuvant radiation may improve pelvic control but does not confer a survival benefit and thus is not routinely recommended. As for endometrial carcinomas, adjuvant chemotherapy is increasingly used. Chemotherapy (e.g. doxorubicin, cisplatin, and ifosfamide; or carboplatin and paclitaxel) can be prescribed for metastatic stromal disease, especially outside the pelvis, but long-term survival is very poor under these circumstances. However, leiomyosarcomas have different chemosensitivities, and doxorubicin, with or without ifosfamide, remains standard. Docetaxel and gemcitabine may be used for relapsed disease.



### The future

Endometrial cancer will probably continue to increase in incidence, as more women live longer. Long-term tamoxifen treatment for breast cancer may merit endometrial screening to identify early change, but screening on a population basis is not currently regarded as an effective strategy.

## Cancer of the cervix

### Aetiology

- Unprotected sexual intercourse.
- HPV.
- HPV types 16 and 18—the US and Europe.
- Vaccination programme started in Europe in 2008.
- Highly variable incidence rates in different countries.
- Globally, second commonest cancer in ♀.

### Epidemiology

The epidemiology of this disease has been extensively studied, and strong associations demonstrated with:

- social deprivation
- multiparity
- cigarette smoking
- early onset of sexual intercourse (before 17y)
- non-barrier forms of contraception
- reduced incidence and mortality in those countries with population screening.

More recent studies have focused attention specifically on papillomavirus transmission and the increased susceptibility of the cervical epithelium of the sexually active teenage ♀.

### Pathology

When the disease is confined to the cervix, patient management depends on the cytology and/or histology specimens. These can reveal a spectrum of changes in the epithelium of the cervix:

- slight dysplastic changes to the cell architecture
- viral cytoplasmic changes
- CIN 1, 2, or 3
- micro-invasive carcinoma
- frank invasive carcinoma.

These early changes may first be identified by examination of a smear of cells, collected by a special wooden (Ayers) spatula or a brush, from the vaginal surface of the cervix. The specimen is a sample of the cells that are being shed from the ectocervix, sometimes along with cells that are being shed from the endocervix and endometrium. They are examined on a slide after staining with Papanicolaou stain, and an impression of the health of the epithelium can be formed.

To accurately map the changes in the cervical epithelium, patients require colposcopy where the cervix is examined by binocular microscopy at ten times the normal magnification.

Viral changes, dysplasia, and CIN 1 and 2 are common in the sexually active adult ♀, particularly among those in their 20s when multiple partners and non-barrier contraception are involved. They can all revert to normal without treatment and are monitored by regular smears. CIN 3 changes are more commonly part of a process that can progress over months or years to invasive carcinoma.

## Staging

The FIGO staging system (see Table 20.3) is based predominantly on the extent of the 1° tumour. Metastatic spread is normally by the lymphatic system.

## Presentation

- CIN and micro-invasive carcinoma usually have no symptoms.
- The earliest symptoms of invasive carcinoma are:
  - vaginal discharge
  - post-coital bleeding
  - intermenstrual or post-menopausal bleeding
  - backache from hydronephrosis and nodal spread.

## Investigations

Asymptomatic patients with CIN 1, 2, or 3 or micro-invasive carcinoma do not require any further investigation prior to treatment. Symptomatic patients should have an examination under anaesthetic to complete FIGO staging, cystoscopy, or sigmoidoscopy if these adjacent organs appear to be involved. CT or MRI scanning of the pelvis and abdomen define more fully the size of the 1° tumour and any lymphadenopathy. PET-CT is increasingly used, as it is more likely to show occult metastases and change the treatment plan. IVU is now considered obsolete.

## Management

### Surgery

- CIN 3 disease localized to the ectocervix—colposcopy and loop diathermy, cryoprobe, or laser:
  - laser produces less distortion and more rapid healing. Diathermy is inexpensive and easy to learn.
- CIN 3 disease extending into the endocervical canal or micro-invasion—cone biopsy.
- Complete excision still requires follow-up or, if the patient wants no more children, hysterectomy and surveillance for the vaginal vault.
- Invasive carcinoma (<4cm, confined to the cervix)—Wertheim's hysterectomy removes the parametrium and pelvic nodes. A recent study with 30mo of survival data has shown stage Ibi cervical cancer has an equally good oncological outcome with laparoscopic radical hysterectomy and pelvic lymphadenectomy.

Table 20.3 FIGO staging system for cervical cancer

Stage	Definition
IA	Micro-invasive disease (max depth 5mm, max width 7mm)
IB	Clinical disease confined to the cervix
IIA	Disease involves the upper third of the vagina, but not the parametrium
IIB	Disease involves the parametrium but does not extend to the pelvic wall
III	Disease involves the lower two-thirds of the vagina and/or the pelvic wall
IV	Involvement of the bladder, rectum, or distant organs

**Radiotherapy**

- Radiotherapy if:
  - incomplete excision of the tumour
  - poor tumour differentiation
  - vascular invasion
  - node involvement
  - all other stages/medically unfit.
- External beam irradiation, followed by intracavitary brachytherapy (ICT).
- 45–52Gy—pelvis over 5wk.
- Sterilizes pre-menopausal patients.
- ICT  $\gamma$  sources ( $^{137}\text{Cs}$  or  $^{192}\text{Ir}$ ) in the uterus/upper vagina.
- Inserted for minutes (HDR); multiple fractions:
  - inserted for ~24h for MDR.
- ICT—dose to central pelvic structures:
  - target dose of 75–85Gy to tumour volume 'A' point
  - dose to the bladder and rectum below 70Gy
  - moving towards customized planning with CT/MRI.
- Pelvic radiotherapy for advanced cancer:
  - minor side effects are common, e.g. 10–20%
  - up to 5% serious late morbidity (bowel and urinary tract)
  - bleeding from proctitis or cystitis
  - stricture or ulceration
  - fistula
  - vaginal shortening/dryness.

**Chemotherapy**

Patients with recurrent pelvic, or systemic metastatic, disease may benefit from palliative chemotherapy. The principal active agents are:

- cisplatin
- MMC
- ifosfamide
- MTX
- fluorouracil
- bleomycin
- paclitaxel
- topotecan.

**Concomitant chemo-irradiation**

The NCI consensus statement of 1999 of clinical trials of chemo-irradiation for cervical carcinoma concluded that there was significant improvement in the OS, local control, and risk of metastatic disease, compared with radiotherapy alone, with the greatest evidence of benefit in stages IB–II disease. All trials demonstrate increased toxicity with combined-modality treatment, so that patient selection is important. A recent update has confirmed this benefit and again shown maximal benefit in earlier-stage disease.

## Results

Survival at 5y is typically as follows: stage Ia, 100%; stage Ib, 70–90%; stage II, 50–70%; stage III, 25–60%; stage IV, 10–20%. The wide ranges reflect the large variation in disease volume seen within the present staging system, which is based on tissue involvement, rather than the volume of disease. Relapse after 5y is unusual.

## Vaginal and vulval cancer

### Vaginal cancer

- Most vaginal malignancies are metastatic, from 1° in the cervix, vulva, endometrium, or trophoblast (choriocarcinoma).
- The commonest histological types of 1° cancer are squamous (80%) and adenocarcinoma (10%).

#### Aetiology

- Recognized association with squamous intraepithelial and invasive neoplasia at other anogenital mucosal and cutaneous sites such as the cervix, vulva, and anus.
- Oncogenic HPV likely to be important in this tumour's biology.
- Smoking is almost certainly a co-factor, as in cervix cancer, and long-term survivors of cervix cancer who continue to smoke are most at risk.

#### Symptoms and signs

##### Symptoms

- Abnormal vaginal bleeding.
- Vaginal discharge.
- Bladder, rectal symptoms.

##### Signs

- Vaginal examination—best method of detection.
- Soft tissue mass—speculum examination.
- Most lesions in upper third and are exophytic.
- Submucosal lesions may indicate metastatic spread from the endometrium or bowel.

#### Staging and investigations

- MRI is the preferred investigation for evaluating local spread, particularly if body or transvaginal coils are used.
- Negative predictive values of CT and MRI for regional nodal involvement remain unsatisfactory.

#### Management

- Radical radiotherapy, with a combination of pelvic external beam and utero-vaginal ICT, is the treatment of choice, especially in stage II.
- The overall 5y survival is 40%, and salvage after first relapse is uncommon.
- Bad prognostic features are 1° adenocarcinoma, large tumour bulk, tumour site (lower vaginal lesions fare worse), and posterior vaginal wall involvement.
- One in five long-term survivors will suffer from serious radiotherapy-related complications.
- Surgery has a limited role—early tumours of the upper posterior vaginal wall need a radical hysterectomy and partial vaginectomy.
- Some US centres use surgery alone for stage II disease.

## Vulval cancer

- 1° invasive vulval cancer; occurs as commonly as cervical cancer in women over 60y.
- One in four tumours occurs in women under the age of 65y.
- The majority (85%) are squamous carcinoma.
- Other types include basal carcinoma (10%) and malignant melanoma (4%).

### Aetiology

- Associations with oncogenic HPV DNA.
- Pre-existing abnormal vulval skin conditions such as a thickened epidermis (squamous hyperplasia).
- Lichen sclerosis.
- Intraepithelial atypia.

### Symptoms and signs

- Tumours are preceded by chronic vulval skin symptoms such as pruritus and irritation.
- Sensation of a painful lump.
- Abnormal genital tract bleeding or haematuria may occur.
- Examination of the external genitalia will identify the majority of tumours.

### Staging and investigations

- Combination of surgical and histopathological investigations.
- The incidence of nodal metastases rises from <1% for tumours with <1mm depth of invasion to over 10% for tumours >3mm in depth.
- Routine node dissection and pathology assessment.
- SLNB may be useful in early disease to spare the sequelae of a full lymphadenectomy.

### Management

- Surgical excision with clear margins and removal of groin nodes (infection and wound seroma occur in 15% of cases). The role of SLNB is not yet established.
- Extensive disease may require complex reconstruction involving the anus, rectum, urethra after radical vulvectomy, and block dissection of inguinal nodes (morbidity is considerable).
- Chemo-irradiation for advanced disease—fluorouracil and MMC or cisplatin and fluorouracil, combined with radiotherapy, give encouraging results.
- For very advanced inoperable disease, neoadjuvant chemotherapy may downsize tumours and render them resectable.
- 5y survival—85% if node-negative.
- Bad prognosis if:
  - >3 regional nodes involved
  - stages III, IV disease
  - large tumour bulk
  - node metastases
  - poor performance status
  - specific tumour type (melanoma).

## Trophoblastic tumours

### Introduction

Gestational trophoblastic disease (GTD) includes a spectrum of disorders:

- complete hydatidiform mole (CHM)
- partial hydatidiform mole (PHM)
- malignant invasive mole, gestational choriocarcinoma.
- highly malignant placental-site trophoblastic tumour (PSTT)
- both CHM and PHM can develop into invasive moles.

Difficulty in diagnosis occurs most frequently with choriocarcinomas and PSTT, which can arise after any type of pregnancy and may not present until many years later, with widespread metastases.

These rare tumours are best managed in specialist centres.

### What is trophoblast?

Within a few days following conception, a ball of cells is formed called the blastocyst, and the outer layer of this ball differentiates into the trophoblast. This consists of an inner layer of cytotrophoblast cells that migrate outwards and fuse to form large multinucleate syncytiotrophoblast cells. The latter produce the pregnancy-associated hormone HCG and invade the myometrium, triggering the formation of new maternal blood vessels that are leaky and supply nutrition to the growing fetus. Trophoblast tissue frequently invades these blood vessels, in both normal and molar pregnancies, and circulates in the blood.

### Hydatidiform moles

#### *Epidemiology*

- 1/1000 pregnancies in the UK.
- 2-fold increase in frequency in South East Asia.
- Commoner after pregnancy when aged <16y or >40y.

#### *Pathology*

- An ovum lacking maternal nucleus DNA fertilized by one or two sperms—duplicate its chromosomes.
- The conceptus is androgenetic.
- Proliferate to give abnormal trophoblastic tissue.
- Partial mole—arises when two sperms fertilize an ovum that has retained nuclear DNA:
  - triploid conceptus proliferation to give an abnormal trophoblast and variable fetal tissue
  - the abnormal trophoblast forms hydropic villi that resemble grapes.

#### *Histology*

- Dilated villi of hyperplastic syncytiotrophoblast and cytotrophoblast.
- Later, cisterns form.
- Large AV shunts form—facilitate spread.

#### *Presentation and staging*

- Bleeding in early pregnancy.
- Anaemia.



- Toxaemia, hyperemesis, hyperthyroidism.
- About 15–20% of complete moles and 0.5% of partial moles will require chemotherapy. Staging of the disease involves ultrasound of the pelvis, serum HCG, and CXR. In most instances, the CXR will be normal, but metastatic disease can present with:
  - cannonball secondaries
  - pleural effusions
  - wedge infarcts
  - oligaemic areas
  - cavitating lesions
  - miliary appearance.

If there are chest lesions, then a CT, or preferably MRI, brain scan is indicated, prior to lumbar puncture for HCG analysis of the CSF (an HCG ratio of >1:60 (CSF: blood) indicates CNS involvement).

### Diagnosis

- Ultrasound—large uterus for dates:
  - CHM—snow-storm appearances, no fetal parts
  - PHM—abnormal placenta, fetal parts seen.
- HCG level high.
- DCIS in 2%.
- Trophoblastic embolism.

### Management

- Gentle suction curettage.
- Spontaneous abortion.
- Hysterotomy; a Caesarean section increases the risks 2-fold of chemotherapy required to eradicate persistent trophoblastic disease.

The information from the staging investigations is used in the scoring system (see Table 20.4) to determine the risk of developing drug resistance to MTX. Patients who score <5 will be cured with MTX alone in at least 75% of cases, whilst only 30% are cured who score 5–8. Nevertheless, the latter patients are also offered MTX therapy to start with, since this treatment carries no risk of long-term sequelae. MTX may cause bleeding through rapid involution of metastases. Patients scoring >9 receive 'high-risk' IV combination chemotherapy, comprising etoposide, MTX, and dactinomycin (EMA), alternating weekly with cyclophosphamide and vincristine (CO). Treatment with either MTX or EMA/CO regimens continues, until the HCG has been normal for 6wk.

### Registration

Three specialist centres in the UK register and oversee the therapy of this rare tumour—Charing Cross (London), Dundee, and Sheffield.

### Follow-up

- Regular HCG measurement.
- Subsequent pregnancies increase the risk of further molar pregnancy.
- Rise in HCG means persistent GTD or invasive mole or choriocarcinoma has developed.

**Table 20.4** Scoring system for gestational trophoblastic tumours

Prognostic factor	Score <sup>a</sup>			
	0	1	2	6
Age (y)	<39	>39		
Antecedent pregnancy (AP)	Mole	Abortion or unknown	Term	
Interval (end of AP to chemotherapy) (mo)	<4	4–7	7–12	>12
HCG (IU/L)	10 <sup>3</sup> –10 <sup>4</sup>	<10 <sup>3</sup>	10 <sup>4</sup> –10 <sup>5</sup>	>10 <sup>5</sup>
ABO blood group (♀ × ♂)		A × 0, 0 × A 0 or A × unknown	B × A or 0 AB × A or 0	
No of metastases	Nil	1–4	4–8	>8
Site of metastases	Not detected Lungs/vagina	Spleen/ kidney	GI tract	Brain/ liver
Largest tumour mass (cm)	<3.0	3–5	>5	
Prior chemotherapy			Single drug	Two or more drugs

<sup>a</sup> The total score for a patient is obtained by adding the individual scores for each prognostic factor. Lower risk, 0–5; medium risk, 6–8; high risk, >9.

If the HCG plateaus or starts to rise, this indicates that the patient has persisting molar disease or has developed an invasive mole (progression to choriocarcinoma and PSTT is rare). If a repeat ultrasound shows evidence of trophoblastic proliferation within the uterus, suction curettage may be performed. However, performing >2 dilation and curettages (D & Cs) is not usually beneficial and will not prevent the subsequent need for chemotherapy. Uterine perforation is more likely if the HCG is >20 000 IU/L, when a second D & C is contraindicated.

Other factors that increase the risk of needing subsequent chemotherapy include age >50y and the use of the oral contraceptive pill whilst HCG is still elevated. Accordingly, all patients are advised to use a barrier method of contraception, following the evacuation of a mole.

## Choriocarcinoma

### Epidemiology

- Follows any type of pregnancy.
- Incidence 1/50 000.
- 3% of CHM develop into choriocarcinoma.
- No geographical trends.

**Pathology**

- Highly malignant.
- Soft, purple, haemorrhagic mass.
- Histology:
  - mimics early blastocyst
  - cores of mononuclear cytotrophoblast
  - rim of multinucleated syncytiotrophoblast
  - no chorionic villi
  - surrounding necrosis, bleeding
  - tumour in venous sinuses.

**Presentation**

- Presents within 1y of pregnancy.
- Vaginal bleeding.
- Abdominal pain.
- Pelvic mass.
- One-third presents with metastases to the liver, brain, or lung.

**Management**

- In most instances, the patient will be transferred to a specialist centre.
- In addition to the staging investigations previously outlined, patients may undergo further tests, including:
  - the measurement of other tumour markers
  - whole-body CT/MRI
  - PET scanning
  - anti-HCG antibody scanning.

Where it can be safely achieved, excision biopsy of a metastasis should be considered. This not only enables histological confirmation of the diagnosis, but also permits genetic analysis to prove the gestational nature of the tumour. If there are only maternal genes, and no paternal genes, present, then the patient has a non-gestational tumour (an ovarian choriocarcinoma or, more rarely, an epithelial tumour that has differentiated into a choriocarcinoma). Frequently, however, biopsy is not possible, and the diagnosis is made on the clinical history and other investigation findings. The patients are then scored and treated, as described for molar disease.

The indications for chemotherapy are:

- evidence of metastases in the brain, liver, or GI tract, or radiological opacities >2cm on CXR
- histological evidence of choriocarcinoma
- heavy vaginal bleeding, or evidence of GI or intraperitoneal haemorrhage
- pulmonary, vulval, or vaginal metastases, unless HCG falling
- rising HCG after evacuation
- serum HCG 20 000IU/L >4wk after evacuation, because of the risk of uterine perforation
- raised HCG 6mo after evacuation, even if still falling.

Any of these are indications to treat, following the diagnosis of GTD.

**Placental-site trophoblastic tumour**

PSTT can develop following a term delivery, non-molar abortion, or CHM. There are currently about 100 recorded cases of PSTT in the literature, and so estimates of its true incidence may well be inaccurate. Nevertheless, PSTT is thought to constitute about 1% of all trophoblastic tumours (choriocarcinoma, invasive mole, and PSTT).

PSTTs are slow-growing malignant tumours, composed mainly of cytotrophoblast, with very little syncytiotrophoblast, so producing little HCG. However, they often stain strongly for human placental lactogen (HPL), which helps to distinguish this tumour from carcinomas, sarcomas, exaggerated placental-site reaction, and placental nodule. The raised HPL may cause hyperprolactinaemia that can result in amenorrhoea and/or galactorrhoea. In most cases, spread occurs by local infiltration, with distant metastases occurring late via the lymphatics and blood.

The behaviour of PSTT is thus quite different from other forms of GTD, and it is relatively chemoresistant. The best management is hysterectomy when the disease is localized to the uterus. When metastatic disease is present, patients can respond and be apparently cured by multi-agent chemotherapy, either alone or in combination with surgery.

**Patient follow-up and prognosis**

On completion of their chemotherapy, patients are advised to avoid pregnancy for 1y and remain on HCG follow-up for life to confirm that their disease is in remission. About 2% of low-risk, and 4% of high-risk, patients will relapse. All low- to middle-risk patients are salvaged with further chemotherapy (EMA/CO or alternative regimens), and the cure rate is almost 100% in this group. The high-risk group has 90% survival rate beyond 10y. With the addition of platinum and other new agents, the salvage rates for patients relapsing, following EMA/CO therapy, can be in excess of 70%. Neither MTX nor EMA/CO therapy reduce fertility or cause abnormalities. Thus, women treated for GTD can expect to have healthy children.

## Further reading

- Aabo K, Adams M, Adnitt P, et al. (1998). Chemotherapy in ovarian cancer: four systematic meta-analyses of individual patient data from 37 randomized trials. Advanced Ovarian Cancer Trialist' Group. *Br J Cancer* **78**, 1479–87.
- Amant F, Moerman P, Nevin P, Timmerman D, Van Limbergen E, Vergote I (2005). Endometrial cancer. *Lancet* **366**, 491–505.
- Cannistra S (2004). Cancer of the ovary. *N Engl J Med* **351**, 2519–30.
- Green JA, Kirwan JM, Tierney JF, et al. (2001). Survival and recurrence after concomitant chemotherapy and radiotherapy for cancer of the uterine cervix: a systematic review and meta-analysis. *Lancet* **358**, 781–6.
- Hockel M, Dornhofer N (2009). Treatment of early endometrial carcinoma: is less more? *Lancet* **373**, 97–8.
- Kim JJ (2008). Human papilloma virus vaccination in the UK. *BMJ* **337**, 303–4.
- Onda T, Yoshikawa M, Mizutani K, et al. (1997). Treatment of node-positive endometrial cancer with complete node dissection, chemotherapy and radiation therapy. *Br J Cancer* **75**, 1836–41.
- Papadopoulos AJ, Foskett M, Seckl MJ, et al. (2002). Twenty-five years' clinical experience with placental site trophoblastic tumors. *J Reprod Med* **47**, 460–4.
- Pellegrino A, Vizza E, Fruscio R, et al. (2009). Total laparoscopic radical hysterectomy and pelvic lymphadenectomy in patients with 1b1 stage cervical cancer: analysis of surgical and oncological outcome. *Eur J Surg Oncol* **35**, 98–103.
- Rose PG, Bundy BN, Watkins EB, et al. (1999). Concurrent cisplatin-based chemotherapy and radiotherapy for locally advanced cervical cancer. *N Engl J Med* **340**, 1144–53.



# Head and neck cancers

- Introduction 468
- Aetiology 470
- Epidemiology 472
- Screening and prevention 473
- Pathology 474
- Presentation 476
- Investigations 478
- TNM staging 480
- Management 482
- Prognosis and follow-up 488
- Rehabilitation 490
- Intra-ocular tumours 492
- Further reading 493

## Introduction

- Head and neck cancer encompasses a range of neoplasms arising from different anatomical sites (see Fig. 21.1):
  - *the larynx*—including the supraglottic, glottic, and subglottic regions
  - *the oral cavity*—including the lips, gums, anterior tongue, floor of the mouth, hard palate, and buccal mucosa
  - *the pharynx*—including the nasopharynx, oropharynx, and hypopharynx
  - *the nasal cavity and paranasal sinuses*—maxillary, frontal, ethmoid, and sphenoid
  - the salivary glands.
- Malignancy of the head and neck is the fifth commonest cancer worldwide and the commonest in central Asia.
- In the UK:
  - the incidence of cancer at each separate anatomical site is relatively low
  - >8000 new diagnoses per year
  - 85% of cases arise in patients aged >50y
  - 'tends to be a disease of deprivation, with the risk of developing disease four times greater for men living in the most deprived areas' (Scottish Intercollegiate Guidelines Network, SIGN)
  - increasing incidence amongst young people of both sexes.
- The term 'head and neck cancer' includes many different diseases. However, most of the skills required to assess and manage these patients are broadly similar.



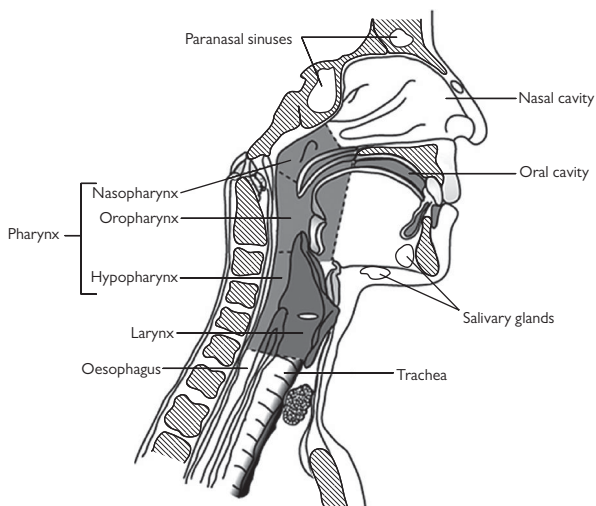

Fig. 21.1 Anatomy of the head and neck.

## Aetiology

### Smoking and alcohol

- Major modifiable risk factors in the Western world.
- Together, they are believed to account for >75% of cases of head and neck cancer.
- The effect on the risk of malignancy is synergistic (multiplicative).
- Cigarette smoking is associated with >10 times greater risk of all head and neck cancers.
- Heavy smoking, combined with excess alcohol consumption, results in >35 times the risk of oral cancer of a person who does neither.
- Chewing tobacco and pipe smoking are particularly associated with oral cancer.
- The role of tobacco is less clear in the aetiology of cancers of the nasal cavity and paranasal sinuses.
- These carcinogens do not have a significant role in the development of cancers of the salivary glands.

### Diet

- Low risk associated with a well-balanced diet rich in vegetables and fruit.
- Increased risk with a poor diet particularly deficient in vitamins A and C.
- Nitrosamines in salted fish implicated in Chinese diet.

### Infections

Virally induced cancers may have a better prognosis than those attributable to smoking and alcohol use.

#### *Human papillomavirus infection*

- Risk factor for cancer of the larynx, pharynx, and oral cavity.
- The association is strongest for cancers of the oropharynx, in particular HPV type 16.
- Particularly relevant in the 25% of cases not related to tobacco and/or alcohol consumption.
- The introduction of a vaccination programme against HPV types 16 and 18 in teenage girls (and, in Australia, boys as well) may impact the incidence of head and neck cancers in years to come.

#### *Epstein–Barr virus infection*

- Associated with the undifferentiated form of nasopharyngeal cancer:
  - analyses of tissue from these tumours confirm all are EBV-positive, with monoclonal viral copies identified within malignant cells
  - the precise role of EBV in malignant transformation remains to be established.
- Also implicated in some salivary gland tumours.

#### *Chronic syphilis infection*

- Implicated in cancer of the oral cavity, in particular the tongue.

### Precancerous lesions

- Certain oral lesions have been identified which may progress to malignancy in some people, e.g. leukoplakia, erythroplakia.
- The incidence of transformation to invasive carcinoma is unclear but is estimated to be <1%/year.

### Genetic susceptibility

- There is believed to be a genetic susceptibility to some of the head and neck cancers:
  - germline mutations in *p53* have been associated with oral cancer
  - certain MHC profiles are associated with nasopharyngeal cancer
  - patients with Fanconi anaemia have a markedly elevated risk of head and neck squamous cell cancer. They also develop significantly greater toxicity with cisplatin chemotherapy and radiotherapy, both treatment modalities commonly used in these cancers.

### Other environmental agents

- Formaldehyde—cancers of the pharynx and oral cavity.
- Hard wood dust—adenocarcinoma of the ethmoids; woodworkers have a 70 times greater relative risk.
- Soft wood dust—SCC of the nasal cavity and paranasal sinuses.
- Radiation exposure—salivary gland tumours, post-radiation sarcoma.

## Epidemiology

### Laryngeal cancer

- Second commonest of the head and neck cancers, although it comprises <2% of all carcinomas in men.
- The annual incidence is 3–10 per 100 000.
- Predominantly a ♂ disease (~5:1 in the UK), as are most head and neck cancers.
- Typical age at diagnosis 40–80y, with ~75% of cases diagnosed in patients aged >60y.
- Lifetime risk of 1 in 175 for men.
- Higher incidence in urban than rural areas.

### Cancer of the oral cavity

- Worldwide, oral cancer has the highest incidence of the head and neck cancers.
- Relatively uncommon in the UK, accounting for ~2% of all new cancer cases in men.
- Patients of South Asian origin are at increased risk.
- ♂ > ♀ (~2:1).
- In the UK, the lifetime risk of developing oral cancer is estimated to be 1 in 85 for men. Geographical variation in the incidence reflects the differing prevalence of the main risk factors for oral cancer—smoking and alcohol intake.
- 10–30% of patients with cancer of the oral cavity subsequently develop a second head and neck 1°.
- The incidence of lung and bladder tumours is also increased in this population.

### Cancer of the pharynx

- Rare in the UK where the commonest site is the tonsil; 400 cases per annum in England.
- The incidence of oropharyngeal cancers which are positive for HPV is increasing, whilst the incidence of HPV-negative oropharyngeal cancers (i.e. those related to tobacco and alcohol) is falling.
- Nasopharyngeal cancer rare in the UK, but more frequent in those of southern Chinese and South East Asian origin, reflecting a combination of differing genetic, dietary, and viral aetiological factors.

### Cancer of the nasal cavity and paranasal sinuses

- Sinonasal malignancy is rare, <3% of head and neck cancers.
- Global figures suggest an incidence of <1/100 000 people per year in most countries.
- Occupational factors produce regional differences.
- ♂:♀ ratio is ~2:1.
- The majority present between 50 and 70y.

### Cancer of the salivary glands

- 3–6% of all head and neck neoplasms.
- Incidence of 1–3 per 100 000/year.
- Cancerous tumours present at a mean age of 60y; benign disease is commoner in a younger age group.

## Screening and prevention

- Currently, there is no national screening programme for this group of cancers.
- In the UK, the emphasis is on public health education to:
  - tackle the major modifiable risk factors of tobacco and alcohol use
  - raise awareness of these cancers and their presenting symptoms
  - reduce the number of patients presenting with advanced stage disease.
- GPs and dentists may have unique opportunities for early diagnosis of these cancers.

## Pathology

### Squamous cell carcinoma

- Account for >90% of cancers of the head and neck, particularly those involving the larynx and oral cavity.
- Categorized as well, moderately, or poorly differentiated, depending on the degree of keratinization.
- Typically, they invade adjacent structures, depending on the site of origin, and spread via the lymphatics to regional lymph nodes in the cervical chain, in preference to blood-borne spread.
- Distant metastases are usually associated with advanced or recurrent 1° tumour and may include mediastinal lymph node, lung, liver, and bone spread.
- There is an association between squamous cell malignancy of the head and neck and several pathological diagnoses believed to represent pre-malignant conditions:
  - *leukoplakia*—hyperparakeratosis ± underlying epithelial hyperplasia. If this is an isolated abnormality, there is believed to be a ≤5% chance of subsequent malignant change
  - *erythroplakia*—superficial red patches adjacent to normal mucosa. Frequently associated with epithelial dysplasia. Associated with CIS or invasive disease in up to 40% of cases
  - *dysplasia*—or CIS (if it involves the full mucosal thickness). Progression to invasive disease is believed to occur in 15–30% of cases.
- A verrucous tumour (also named Ackerman's tumour):
  - variant of well-differentiated SCC
  - presents as a whitish, cauliflower-like growth
  - histology confirms a pushing margin, with a marked surrounding inflammatory cell response
  - lymphatic spread is rare.
- Spindle cell carcinomas behave as SCCs.

### Other pathologies

#### Histology

- Adenocarcinomas arising from salivary tissue, e.g. in the oral cavity.
- Melanoma.
- Sarcoma, e.g. osteosarcoma, rhabdomyosarcoma.

#### Timing

Patients with head and neck squamous cancer are more likely to develop second 1° cancers than any other group of patients with malignancies. These may be:

- synchronous:
  - occurring at, or near, the same time as the original tumour.
- metachronous:
  - occurring >6mo later.
- ~15% of 'cured' patients with previously treated head and neck cancer present with further 1° (at a rate of 3–5% per year)

- The mucosa adjacent to the carcinoma frequently contains areas of dysplastic changes, CIS, or occult invasive carcinoma
- High risk of multiple 1° reflects the carcinogenic effects of prolonged exposure to tobacco and alcohol over the whole of the aerodigestive tract and urothelium ('field effect')
- Second tumours are often clonally distinct and therefore are not felt to represent loco-regional recurrence or metastatic spread from the original 1°.

### Tumours of the salivary glands

- Represent a very different spectrum of diseases, compared to the commoner head and neck tumours.
- The commonest location of a salivary gland tumour is the parotid gland (70–85%).
- Most parotid tumours are benign (>75%).
- Tumours of the minor salivary glands represent only 5–8% of salivary gland disease, but >80% of these are cancerous.
- The most frequent salivary gland tumour is the pleomorphic adenoma (also known as the mixed parotid tumour):
  - a benign epithelial tumour that only rarely undergoes malignant transformation
  - local recurrence, following enucleation, is common
  - treatment is most commonly with formal parotidectomy.
- Malignant tumours that occur in the salivary glands include:
  - mucoepidermoid carcinoma
  - adenocarcinoma
  - squamous carcinoma
  - adenoid cystic carcinoma
  - undifferentiated carcinoma
  - metastasis from other 1° sites, e.g. breast or lung cancer
  - lymphoma.

## Presentation

- Characteristic local symptoms depend on the site and size of the 1° lesion.
- Malignancy of the head and neck may not uncommonly present with painless cervical lymphadenopathy.
- Any of the symptoms listed should raise suspicion, particularly when occurring in:
  - ♂
  - >45y old
  - the context of heavy alcohol/tobacco usage.

### Laryngeal cancer

- A hoarse voice is typical if the cancer is affecting the glottis (the commonest site of laryngeal cancer in the UK and US). Urgent referral should be made if this persists >6wk.
- A persistent irritating cough and dysphagia or odynophagia (painful swallowing) are characteristic of supraglottic carcinoma, which typically presents with advanced disease, often including a palpable neck mass.
- Dyspnoea/stridor can be caused by subglottic cancers that grow circumferentially. These are rare (<5%).
- ± referred pain in the ear.
- ± haemoptysis.

### Cancer of the oral cavity

- Persistent mouth ulcers, painful ulcerative lesion on the lip, or exophytic growth lasting >3wk.
- White or red patches on the tongue, gums, or lining of the mouth.
- Dental problems, e.g. loose teeth, dentures no longer fitting.
- Dysphagia/odynophagia.
- Numbness/change in sensation of the lower lip or chin.
- Referred pain in the ear.
- Dysarthria if there is involvement of the tongue.
- Lymphadenopathy.
- Weight loss.

Tumours commonly extend to involve >1 region within the oral cavity:

- tongue, 60%
- floor of the mouth, 15%
- alveolar ridge/retromolar trigone, 10%
- buccal mucosa, 10%
- hard palate, 5%.

### Cancer of the pharynx

The pattern of symptoms tends to differ, according to the 1° site of disease.

#### *Nasopharyngeal cancer*

- Cervical lymphadenopathy (up to 90% of patients).
- Nasal symptoms—bleeding, obstruction, or discharge.
- Unilateral hearing loss ± serous otitis media (2° to Eustachian tube blockage) ± tinnitus.



- Headache.
- Cranial nerve palsies due to base of skull invasion.

#### *Oropharyngeal cancer*

- Sore throat or lump in the throat.
- Pain referred to the ear.

#### *Hypopharyngeal cancer*

- Dysphagia and lump in the throat.
- Odynophagia.
- Pain referred to the ear.
- Hoarse voice.

### **Cancer of the nasal cavity and paranasal sinuses**

- Epistaxis.
- Unilateral nasal obstruction  $\pm$  serosanguinous or purulent discharge.
- Pain and paraesthesiae, especially of the cheek, nose, or upper lip.
- Ulceration.
- Proptosis, diplopia, chemosis  $\pm$  visual loss if there is involvement of the orbit with displacement of the globe.

### **Tumours of the salivary glands**

- Painless lump within the substance of a salivary gland, as opposed to enlargement of the whole gland.
- Differentiation between an enlarged gland and a lump in the gland is often difficult.
- Benign and malignant salivary gland tumours may be indistinguishable clinically.
- Features highly suggestive of malignancy include:
  - infiltration of surrounding structures
  - facial pain
  - facial nerve palsy.

## Investigations

The aims of investigations include:

- identifying the 1° tumour site and extent—including cytological or histological confirmation of the diagnosis
- detecting any other synchronous 1°—not uncommon in this group of patients
- staging the disease.

It is also important to assess general fitness because:

- significant co-morbidities, such as ischaemic heart disease (IHD) and obstructive airways disease, are common in patients with head and neck cancer, primarily because of shared aetiological risk factors
- surgical management is often optimal, necessitating a general anaesthetic. Positive steps to minimize the anaesthetic risk should begin as soon as the potential need for surgery is identified, e.g. control of hypertension.

### Physical examination

This should include:

- a thorough visual inspection of the region, including mirror examination. This has largely been superseded by flexible fiberoptic endoscopy—to allow visualization of the nasopharynx, hypopharynx, base of the tongue, larynx, and vocal cord mobility
- bimanual examination of the oral cavity
- palpation of regional lymph nodes—cervical lymph node spread is an important determinant of prognosis. However, clinical examination should be combined with appropriate imaging due to the high false negative rate (15–30% for cervical lymph nodes) and false positive rate (30–40% for cervical nodes) from clinical examination alone
- general physical examination—as a clinical assessment of potential metastatic disease (which is commonly asymptomatic)
- ± examination and biopsy under anaesthesia.

### Bloods

- FBC, and urea and electrolytes (U & Es).
- LFTs and coagulation screen—commonly abnormal because of concomitant alcohol excess.

### Imaging

- The extent of imaging will depend on the site and size of the 1° tumour, e.g. early laryngeal cancer has a very low risk of distant spread and requires only loco-regional cross-sectional imaging.
- CT scan to determine:
  - the extent of local tumour infiltration, particularly invasion of bone/cartilage (T4 disease)
  - the radiological evidence of regional nodal involvement
  - the development of synchronous 1° tumours
  - the presence of distant metastases
  - the commonest sites of dissemination being the lungs, then the liver, then bones.

- MRI of the head and neck:
  - may provide better soft tissue definition.
- FDG-PET-CT scan—this is now part of the standard work-up of patients with advanced head and neck cancer, or those at high risk of distant metastases, and picks up local and distant nodal spread. Whilst local disease may still warrant surgery, more limited surgery to control symptoms may be appropriate, if distant spread is diagnosed.
  - Images reflect the rates of glucose metabolism within tissues.
  - Particularly useful in identifying occult 1° tumours in patients presenting with confirmed nodal disease.
  - Increasing role, particularly in patients where tumour staging is unclear, despite CT/MRI.
  - Superior to MRI and CT for detecting second 1°, and regional and distant metastases.
- USS:
  - often relatively straightforward to arrange and useful for guiding FNA
  - can identify nodal metastases, even when nodal disease not clinically apparent (~20% of cases).
- Skeletal scintigraphy:
  - if bone metastases suspected, but not identified on CT
  - e.g. in nasopharyngeal cancer, ~25% of patients with low cervical or supraclavicular nodes, who have a positive bone scan, will have 2°.
- PET:
  - not used in isolation, as provides inadequate anatomical detail.

### Histology

- Biopsy—if the 1° tumour is identified and accessible. The exception is salivary gland tumours when FNA is preferred to biopsy to minimize the risk of tumour seeding.
- FNA—of a metastatic lymph node mass; non-diagnostic in up to 15% of cases, although this figure improves with the use of ultrasound guidance.

## TNM staging

- Staging systems for head and neck cancers are based on the 'TNM system' and are broadly similar for each of the anatomical sites of origin.
- Details that differ between the staging systems typically take into account of whether the involvement of particular local structures will affect if radical treatment is appropriate, and hence the effect on the overall prognosis.
- T—the extent of the 1° tumour:
  - generally reflects the size of the tumour ± involvement of bone or cartilage (T4)
  - for some sites, T4 tumours are further divided into potentially resectable (T4a) or unresectable (T4b).
- N—involvement of regional lymph nodes.
- M—the absence (0) or presence (1) of distant metastases or the inability to assess for their presence (X).

The AJCC staging system for laryngeal cancer, updated in 2010, is given as an example (see  <https://cancerstaging.org> to download the TNM staging).



## Management

- Investigation and management should be coordinated by an MDT with expertise in the complex medical, psychological, and functional issues that affect patients with head and neck cancers.
- The MDT should be serving a large enough population, such that they maintain sufficient expertise in these cancers. The more unusual cancers need to be managed by even more specialized teams within the network.
- Coexisting socio-economic deprivation can complicate management.
- Compliance may be problematic.
- Support services available should include:
  - clinical nurse specialists
  - dentists
  - dieticians
  - speech and language therapists.

### Pre-malignant lesions

- Pre-malignant lesions require specialist management because:
  - they may subsequently develop into frank carcinoma
  - patients with pre-malignant lesions are at high risk of other 1° malignant neoplasms, especially within the upper aerodigestive tract and lungs.
- Treatment is usually by excision, followed by examination by an experienced pathologist.
- Classification should be based on the grade of dysplasia, as this has a bearing on prognosis.
- Radiotherapy may be appropriate for frequently recurring or diffuse lesions, e.g. on the vocal cords.

### Malignant lesions

- The aim of treatment is to combine optimal rates of cure with the best functional results.
- Where cure is not feasible, every attempt should be made to provide loco-regional disease control.
- Before beginning treatment, it is important to:
  - establish the nutritional status—including the baseline weight and the risk of malnutrition during therapy (elective insertion of an NG or enterostomy feeding tube may be appropriate). A specialist dietician should be involved, wherever possible
  - refer for dental assessment—including the completion of any necessary dental treatment. Ongoing mouth care advice will be needed during and after treatment
  - correct anaemia—Hb must be maintained at  $\geq 12\text{g/dL}$  throughout treatment for optimal results from radiotherapy
  - encourage smoking cessation. Continued smoking during treatment has multiple risks
    - greater anaesthetic risk
    - higher complication rate following radiotherapy
    - lower rates of local control
    - lower probability of survival
- undertake a speech and language assessment.

- There are few randomized trials comparing treatment modalities—the evidence is mainly at level III (i.e. based largely on retrospective case series). This is partly due to the relative rarity of tumours arising from each anatomical site.
- Most head and neck cancers are treated with surgery, radiotherapy, or a combination of the two:
  - generally, T1–2, N0, M0 disease can be treated with single-modality treatment, and retrospective data suggest the results achieved by surgery or radiotherapy alone are equivalent, although the side effect profiles are different
  - in more advanced disease, combined-modality regimes are frequently adopted, depending on the 1° site.

### Management of early-stage disease

- 30–40% of patients with head and neck cancer present with stage I or II disease, with an overall prognosis of 60–98%, depending on the site of the 1°, etc.

#### *Surgery alone*

- Potential advantages of surgery alone include:
  - complete pathological staging of the disease
  - quick local clearance of the disease
  - newer surgical techniques, e.g. for early laryngeal cancer, may conserve the voice
  - treatment of metachronous head and neck tumours is not compromised
  - avoids the toxicity of radiotherapy, including the risk of radiotherapy-induced second malignancies
  - for major salivary gland tumours, preoperative open biopsy should be avoided (risk of tumour seeding). However, fine needle biopsy, with an experienced head and neck cytopathologist, is safe. 1° excision can be used as a simultaneous diagnostic and therapeutic procedure.

#### *Radiotherapy alone*

- Recent advances in imaging techniques and radiation delivery have benefited patients with head and neck cancers.
- A typical radiotherapy regime might comprise 60–70Gy, administered to the 1° site over 6–7wk.
- Treatment may be with external photon beams alone or with photons followed by an electron boost, or by interstitial therapy, e.g. using iridium wire.
- IMRT (see Chapter 4) is increasingly available and permits better control of the delivered radiation dose. Randomized trials have demonstrated that IMRT is associated with significantly lower rates of some side effects, e.g. dry mouth.
- Advantages of 1° radiotherapy include:
  - the avoidance of operative mortality in patients who have significant co-morbidities
  - surgical clearance may be difficult or impossible

- organ conservation is more likely, including the preservation of the voice and swallowing
- option of elective radiotherapy treatment of clinically occult regional lymph node disease, with relatively little extra morbidity (compared with elective neck dissection)
- surgery remains an option as salvage therapy in the event of treatment failure. However, subsequent surgery is likely to be associated with greater morbidity, e.g. total laryngectomy is usually required after failure of 1° radiotherapy for laryngeal cancer
- allows the treatment of multiple synchronous 1°.
- Toxicity of radiotherapy includes:
  - mucositis and dry mouth (xerostomia)—may persist, depending on the amount of salivary tissue spared from irradiation
  - chronic ulceration of the mucosa and osteonecrosis—particularly with locally advanced tumours involving the mandible
  - dry eye/cataract, pituitary dysfunction, and CNS necrosis—the radiation dose to the eyes, brain, and spinal cord must be kept within tolerance. Conformal techniques and CT planning allow reduction in the dosage to normal tissue.

#### *Surgery versus radiotherapy*

- Cure rates with 1° radiotherapy are generally believed to be equivalent to those for surgery for early-stage disease of many head and neck tumours.
- In certain clinical situations, radiotherapy is clearly the first-line treatment of choice, e.g. in nasopharyngeal carcinoma when the use of surgery is limited to staging.
- In other clinical situations, surgery is the first choice, if at all possible, e.g. tumours of the nasal cavity and paranasal sinuses.

#### *Combined surgery and radiotherapy*

- Combination therapy is generally the best choice for bulky tumours. The aim of using both modalities is to minimize the risk of loco-regional disease recurrence.
- The most important risk factors for the prediction of recurrence and the need for post-operative radiotherapy are:
  - positive resection margins
  - extracapsular lymph node spread
  - T3–4 1° tumour
  - perineural or vascular invasion
  - poorly differentiated tumour
  - ≥N2 disease.

#### *Management of involved neck nodes*

Options include the following:

- therapeutic radiotherapy:
  - appropriate for N1 disease, particularly if radiotherapy is also being used to treat the 1°
  - 60–65Gy, administered over 6wk, will control 90% of N1 nodes



- therapeutic neck dissection:
  - should be considered for patients with more advanced nodal disease (N2–3) and an operable 1°
  - there are no prospective trials to support subsequent adjuvant radiotherapy, but retrospective series suggest it has a role if there is a high risk of local relapse
- radical neck dissection:
  - removes the superficial and deep cervical fascia with the enclosed lymph nodes (levels I–V), along with the sternomastoid muscle, omohyoid muscle, internal and external jugular veins, accessory nerve, and submandibular gland
- modified neck dissection:
  - preserves vital structures such as the accessory nerve (functional dissection).

Complications after neck dissection include:

- haematoma
- seroma
- lymphoedema
- infection
- damage to VII, X, XI, and XII cranial nerves
- carotid rupture.

*Post-irradiation neck dissection*

- May be planned electively after radiotherapy (e.g. 50Gy) for advanced nodal disease.
- More commonly used to salvage regional relapse after radiotherapy.

The role of SLNB and the management of micrometastases are uncertain. In many centres, SLNB is being established.

*Post-operative chemo-radiotherapy*

- Results published in 2004 from two large randomized trials support the use of post-operative chemo-radiotherapy in selected high-risk fit patients with resected squamous cell head and neck cancers.
- Radiotherapy with concurrent administration of cisplatin:
  - has been associated with fewer loco-regional relapses and improvements in DFS
  - an improvement in OS has not been consistently demonstrated
  - the incidence of significant toxicity in the patients receiving both cisplatin and radiotherapy was over double the incidence in patients receiving radiotherapy alone.

## Treatment of locally advanced unresectable disease

*Chemo-radiotherapy*

- >60% of squamous cell head and neck cancers have advanced loco-regional disease at presentation (stages III/IV, M0).
- In some cases, surgery remains an option and can result in 5y survival rates of 20–50%, if combined with radiotherapy.
- In many cases, surgery is either technically not possible or would be associated with unacceptable morbidity, e.g. base of tongue cancer requiring glossectomy and consequent loss of normal voice and swallow.

- Significant co-morbidity may also mean that the operative risk is deemed too great.
- 1° radiotherapy for unresectable stage III or IV head and neck cancer is associated with a 5y survival of only 10–30%.
- Combined-modality therapy:
  - the use of radiotherapy with concurrent chemotherapy in such cases has been demonstrated to be associated with a modest survival advantage over treatment with radiotherapy alone (4–8% increase in 5y survival)
  - the most commonly studied chemotherapy regime so far has been single-agent cisplatin, although combination regimes have also been used and may be associated with further improvements in outcome
  - associated with increased toxicity, in particular mucositis
  - most appropriate in patients with good performance status and relatively few co-morbidities.
- The rationale for adding chemotherapy to radiotherapy includes:
  - its role as a radiosensitizer
  - its cytotoxic effects on occult metastatic cells
  - the potential for limiting repair of radiation-induced DNA damage.

### *Biological therapies*

#### Cetuximab:

- an IV administered human/mouse chimeric IgG mAb
- competitively binds to the EGFR, preventing TK activation and inhibiting, amongst other cellular processes, tumour proliferation (see Chapter 9). EGFR is overexpressed in many head and neck cancers, e.g. ~90% of head and neck squamous cell cancers
- a randomized trial compared radiotherapy alone versus the combination of radiotherapy and concurrent weekly cetuximab in >400 patients with locally advanced SCC of the head and neck. The use of cetuximab was associated with significant improvements:
  - longer duration of loco-regional control (24.4mo versus 14.9mo)
  - greater median OS (49mo versus 29.3mo)
  - no increase in mucositis, although significant skin toxicity was more frequent in the group receiving combined-modality treatment
- cetuximab was given NICE approval in 2008 for the treatment of fit patients (Karnofsky score  $\geq 90\%$ ) with locally advanced head and neck cancer receiving radiotherapy, for whom all platinum-based chemotherapy is inappropriate
- the level of EGFR overexpression does not correlate with the clinical response to cetuximab. Instead, mutation in the *KRAS* gene correlates with poor response to cetuximab. *KRAS* wild-type status predicts benefit from cetuximab. ~95% of head and neck squamous cell cancers are *KRAS* wild-type.

## Management of metastatic disease

### Chemotherapy

#### *Advanced squamous cell carcinoma*

- Prognosis is poor, with a median survival of only 6–9mo.
- Treatment choices for recurrent or metastatic disease depend on whether treatment has previously been received for early-stage disease.
- Certain chemotherapy agents have been shown to be active, e.g. cisplatin, the taxanes (docetaxel and paclitaxel), fluorouracil, MTX, and pemetrexed.
- Cetuximab is also active in advanced disease.
- Single-agent therapy:
  - the median survival with treatment is only around 6mo
  - e.g. MTX, cisplatin, or cetuximab (approved for use in the US for platinum-refractory disease).
- Combination regimes:
  - appear to achieve the highest response rates (15–30%)
  - a survival advantage over single-agent treatment has not been consistently demonstrated
  - can only be considered in patients with good performance status
  - e.g. a platinum agent with either fluorouracil ± cetuximab, or alternatively with a taxane.
- Nasopharyngeal carcinomas seem particularly chemosensitive, with response rates of up to 70% reported in advanced disease.
- Good communication is critical in helping the patient weigh up options for palliative treatment and in approaching end of life issues. Early involvement of clinical nurse specialists and palliative care nurses can ease the transition from curative to palliative treatment.

#### *Disseminated or unresectable salivary tumours*

- Typically chemosensitive.
- Response rates of up to 50% are reported.
- The duration of response is usually only a few months.
- The regime chosen can be tailored to the histology of the disease.

## Prognosis and follow-up

Follow-up is important in patients treated with curative intent for head and neck cancer. The aims of surveillance include:

- early detection of loco-regional recurrence:
  - occurs in 20–50% of patients
  - the major contributor to head and neck cancer-related deaths
  - early detection will improve the chances of successful salvage therapy
- detection of new 1°:
  - the incidence of new 1° cancers is 3–5% per year (10–15% overall)
- management of the late effects of treatment.

The role of routine PET-CT scanning in follow-up is increasingly used. It may help to diagnose early relapse, e.g. when CT shows equivocal abnormalities.

### Laryngeal cancer

- 90% of recurrences occur within 3y.
- High risk of second 1° malignancies (12–20%).
- Patients with supraglottic laryngeal cancer are at particular risk of subsequent 1° lung cancer—CXR, and even bronchoscopy, may be considered in regular follow-up. Spiral CT may also have a role.

### Cancer of the oral cavity

- >80% 5y survival for those presenting with early-stage, localized disease.
- >40% 5y survival for patients with loco-regional nodal involvement.
- <20% 5y survival for those with distant metastases.

### Cancer of the pharynx

- Reported 5y survival rates for nasopharyngeal carcinoma range from >80% for stage I disease to <30% for patients presenting with advanced tumours.
- Follow-up after treatment for early-stage disease should be most intensive in the first 3y, when the majority of recurrences occur.
- The prognosis is less good for localized oropharyngeal cancers, with a 5y survival of ~50% for those presenting with stage I disease, although survival with advanced disease is similar to that with metastatic nasopharyngeal cancer.
- Tonsillar cancer, in general, has a better prognosis, with survival of >80% at 5y, even for stage III disease.
- Patients with HPV-positive oropharyngeal cancer have a better prognosis than those whose cancers are HPV-negative.

### Cancer of the nasal cavity and paranasal sinuses

- Presentation is most commonly with locally advanced tumours that remain potentially curable with radical surgery and radiotherapy.
- Regional metastases are infrequent—occurring in <20% of patients at presentation.

### Cancer of the salivary glands

- The 5y survival is 75–85% for those presenting with early-stage, localized (stage I) malignant disease of the salivary glands but falls to ~30% for patients presenting with disseminated disease (stage IV).
- More than one-fifth of recurrences occur over 5y, following treatment for the 1° disease.

## Rehabilitation

- The treatment of many head and neck cancers has significant associated long-term morbidity.
- Patients may have to adjust to huge changes in both appearance and function.
- A high level of specialist support from many different disciplines in the months and years following their treatment can significantly improve the quality of life.

Specific difficulties that require ongoing input include the following.

### Speech

- The greatest handicap for patients after a total laryngectomy is the loss of voice.
- Options include:
  - oesophageal speech—~40% of patients acquire socially useful speech using this method
  - artificial larynx device—used successfully by some patients
  - fistula operations with the insertion of speech valvulas—increasingly performed and well tolerated
  - specialist speech and language therapists—should be involved throughout the patient's care
  - support groups or web-based information sites helpful, e.g. ☞ <http://www.theial.org>

### Airway management

- Patients may have to adjust to breathing through a stoma.
- If the airway has been separated from the gullet, they will have to learn to manage their airway secretions.
- Heat and moisture exchangers are commonly used to lower the risk of respiratory problems and can be positioned in front of the stoma.

### Dentistry

- Specialist dentists should be involved in follow-up, due to the specific problems that occur following, e.g. radiotherapy to the mouth. These include:
  - frequent dental caries
  - poor healing after tooth extraction
  - the potential for late osteoradionecrosis.

### Nutrition

- Malnutrition is a particular risk in patients with head and neck cancers, with up to three-quarters of patients being malnourished at the point of diagnosis.
- There is considerable morbidity associated with poor nutrition. Treatment given to malnourished patients is associated with:
  - higher complication rates
  - lower response rates.

- Malnutrition is multifactorial and may be due to:
  - *pre-existing lifestyle factors*, e.g. alcohol, poor self-care
  - *direct effects of the cancer*, e.g. local pain, obstruction
  - *acute effects of treatment*, e.g. nausea, post-operative pain
  - *late effects of treatment*, e.g. ↓ saliva, difficulty swallowing, difference in taste.
- Input from a dietician, with expertise in patients treated for head and neck cancers, is vital.

### Psychological support

- Many patients with cancer share common stresses, including the fear of recurrence, the uncertainty for the future, etc.
- Patients with head and neck cancers often experience additional stresses specific to their diagnosis. These include:
  - change in appearance, e.g. facial disfigurement
  - change in function, e.g. feeding, speech.
- The adjustment to changes in appearance can also be problematic for relatives.
- Regular psychological assessments and specialized psychological support should be routinely available to patients diagnosed with head and neck cancers.
- Patient support groups and self-help literature also have a role in helping patients and their relatives to cope.

### Ongoing alcohol and tobacco dependency

- Strenuous efforts must be made to encourage patients to stop smoking and cut back on their alcohol intake.
- Currently, there is little evidence to support formal smoking cessation programmes, e.g. in a trial of newly diagnosed patients with head and neck cancer, randomized to either 'usual care' or a formal smoking cessation programme, the rate of ongoing smoking after 1y fell by the same amount (88% → 70%).

## Intra-ocular tumours

### Melanoma

- See ↻ Intra-ocular melanoma, p. 540.

### Retinoblastoma

- Rare intra-ocular tumour, arising in young children, usually in the first 2y of life; incidence of 1 in 20 000.
- The disease is hereditary (autosomal dominant) and often bilateral.
- Patients should be managed in combined clinics by ophthalmologists experienced in the management of retinoblastoma.
- Biopsy should not be performed.

### Management

- Small tumours not adjacent to the macula or optic disc—photocoagulation.
- Small/moderate tumours—radioactive plaques (iodine, ruthenium plaques—40Gy).
- Large or multiple tumours—external radiotherapy.
- May need to irradiate the whole eye (40Gy, 20 fractions over 4wk); try to maintain vision.
- Occasionally, enucleation is required—if the tumour fills the whole globe.
- The tumour is also chemosensitive:
  - platinum
  - etoposide
  - vincristine
  - doxorubicin
  - cyclophosphamide.
- Chemotherapy is useful if the tumour has a bad prognosis or in neoadjuvant setting.
- Prognosis—90% survival; 80% of patients can have the eye preserved.

### Metastatic disease

- Metastatic disease involving the eye is usually associated with choroidal metastases.
- The commonest tumours implicated are the lung and breast.
- An oncological emergency, if vision threatened.
- Usually treatment with radiotherapy.



## Further reading

- Curado MP, Boyle P (2013). Epidemiology of head and neck squamous cell carcinoma not related to tobacco or alcohol. *Curr Opin Oncol* 25, 229–34.
- National Institute for Health and Care Excellence (2012). *Improving outcomes in head and neck cancers: evidence update May 2012*. Available at: <https://www.evidence.nhs.uk/evidence-update-17>.
- Roland NJ, Paleri V (eds.) (2011). *Head and neck cancer: multidisciplinary management guidelines*, 4th edn. London: ENT UK. Available at: [https://www.entuk.org/sites/default/files/files/head\\_and\\_neck\\_cancer.pdf](https://www.entuk.org/sites/default/files/files/head_and_neck_cancer.pdf).
- VanderWalde NA, Fleming M, Weiss J, Chera BS (2013). Treatment of older patients with head and neck cancer: a review. *Oncologist* 18, 568–78.



# Tumours of the central nervous system

Primary central nervous system tumours 496

Investigations and staging 502

Treatment of primary central nervous system tumours 504

Radiotherapy for primary central nervous system tumours 510

Chemotherapy for primary central nervous system tumours 513

Prognosis for primary central nervous system tumours 514

Recent advances and future treatments for primary central nervous system tumours 516

Brain metastases 518

Further reading 521

## Primary central nervous system tumours

### Epidemiology

The incidence worldwide is very uniform, with a few exceptions such as a higher incidence of pineal tumours in Japan and CNS lymphoma in acquired immune deficiency syndrome (AIDS) populations. Recent reports suggest that the incidence of glioma and (non-AIDS) lymphoma is increasing in developed countries. In the UK:

- ~9300 1° tumours of the CNS were diagnosed in 2009
- 1° CNS tumours account for 2% of all malignancies
- in 2010, there were 4800 deaths from 1° tumours of the CNS
- almost half of intracranial tumours may not be registered, so current statistics may significantly underestimate the true number
- peak incidence 70–80y
- as the proportion of the elderly in the population rises, the incidence is expected to rise
- 1° brain tumours show a bimodal age distribution:
  - in children, they are the commonest solid malignancies, around 390 cases annually in the UK, predominantly arising in the posterior fossa
  - second peak in (late) middle age with largely supratentorial tumours.

### Aetiology

- The majority of 1° CNS tumours are sporadic.
- The main risk factors are increasing age, ♀ sex, and higher socio-economic status.
- Gliomas and meningiomas may be induced by radiation.
- There is an association between 1° CNS lymphoma and immunosuppression, including HIV infection.
- A number of rare familial syndromes are associated with CNS tumours (see Table 22.1).
- Other candidate aetiological agents remain controversial and unproven, e.g. industrial and agricultural chemicals, electromagnetic fields, viruses, and trauma.

### Pathology

The 1° CNS tumour pathology is extremely varied, reflecting a diverse histogenesis.

The terms benign and malignant are not useful because:

- even small, slow-growing tumours may cause severe and detrimental symptoms, because the brain is contained within a rigid structure
- surgery may be difficult due to infiltration of surrounding structures and/or close proximity to critical structures
- most tumours rarely metastasize outside the CNS
- slow-growing tumours may transform into a more aggressive type.

**Table 22.1** Hereditary syndromes associated with 1° CNS tumours

Syndrome	Gene	Chromosome	Associated tumours
Neurofibromatosis type 1	<i>NF1</i>	17q11	Neurofibroma, optic nerve glioma, astrocytoma, malignant nerve sheath tumour
Neurofibromatosis type 2	<i>NF2</i>	18q22	Astrocytoma, multiple meningioma, bilateral acoustic schwannoma, glial hamartoma
Li–Fraumeni syndrome	<i>p53</i>	17p13	Astrocytoma, primitive neuroectodermal tumour
vHL syndrome	<i>VHL</i>	3p25	Cerebellar haemangioblastoma
Gorlin's syndrome	<i>PTCH</i>	9q22	Medulloblastoma
Tuberous sclerosis	<i>TSC1</i>	9q34	Subependymal giant cell astrocytoma
	<i>TSC2</i>	16p13	
Turcots's syndrome	<i>APC</i>	5q21	Medulloblastoma, glioblastoma
	<i>HMLP1</i>	3p21	
	<i>HPSM2</i>	7p22	
Cowden disease	<i>PTEN</i>	10q23	Dysplastic gangliocytoma of the cerebellum

The most widely used classification system is the WHO 2007 scheme (see Table 22.2). This classifies CNS tumours into the basic types of tumours of neuroepithelial tissues, germ cell tumours, tumours of the peripheral nerves, tumours of the meninges, lymphomas and haematopoietic tumours, tumours of the sellar region, and metastatic tumours. Each type has further subdivisions.

The WHO classification also describes tumours by their histopathological grade: low grade (slow-growing, types I and II) and high grade (rapidly growing and aggressive, types III and IV).

1° CNS tumours can be divided into 1° intracranial tumours and spinal cord tumours, which account for 90% and 10%, respectively. The frequency of intracranial pathologies is shown in Table 22.3. Spinal cord tumours can be described by their relation to the spinal cord and dura. The pathologies occurring at these sites are shown in Table 22.4. The commonest 1° spinal tumour is schwannoma, followed by meningioma and ependymoma.

By far, the commonest 1° CNS tumour is the glioma—the behaviour and prognosis are strongly linked to the histological grade:

**Table 22.2** Abbreviated WHO (2007) classification of CNS tumours

Tissue of origin	Tumour group	Pathological diagnosis
Neuroepithelial tumours	Astrocytic tumours	Pilocytic astrocytoma
		Diffuse astrocytoma
		Anaplastic astrocytoma
		Glioblastoma
	Oligodendroglial tumours	Oligodendroglioma
		Anaplastic oligodendroglioma
	Mixed gliomas	Oligoastrocytoma
		Anaplastic oligoastrocytoma
	Ependymal tumours	Myxopapillary ependymoma
		Subependymoma
		Ependymoma
		Anaplastic ependymoma
	Neuroepithelial tumours of uncertain origin	Astroblastoma
Gliomatosis cerebri		
Malignant peripheral nerve sheath tumour (MPNST)		
Neuronal and mixed neuronal–glial tumours	Gangliocytoma	
	Ganglioblastoma	
	Neurocytoma	
Embryonal tumours	Medulloblastoma	
	PNET	
Choroid plexus tumours	Choroid plexus papilloma	
Pineal parenchymal tumours	Pineocytoma	
	Pineoblastoma	
Meningeal tumours	Meningioma	
	Haemangiopericytoma	
Germ cell tumours	Germinoma	
	Embryonal carcinoma	
	Yolk sac tumour	
	Choriocarcinoma	
	Teratoma	
Tumours of cranial and paraspinal nerves	Mixed germ cell tumour	
	Schwannoma	

Table 22.2 (contd.)

Tissue of origin	Tumour group	Pathological diagnosis
Tumours of the sellar region		Pituitary adenoma
		Pituitary carcinoma
		Craniopharyngioma
1° CNS lymphoma		Malignant lymphoma
		Plasmacytoma
Metastatic tumours		

Table 22.3 Frequency of 1° intracranial tumours

Tumour type	Frequency (%)
Glioma	45
Meningioma	27
Pituitary	10
Nerve sheath	7
Lymphoma	4
Medulloblastoma and other PNETs	2
All neuron and neuron/glial tumours	1
Germ cell tumours	<1
Craniopharyngioma	1
Choroid plexus	<1
Other	3

Table 22.4 Classification of spinal cord tumours by their relation to the spinal cord and dura

Location	Tumour type
Extradural	Metastatic (carcinoma, lymphoma, melanoma, sarcoma)
	Chordoma
Intradural	
Intramedullary	Astrocytoma, ependymoma
Extramedullary	Schwannoma, meningioma

- grade I—slow-growing and may be cured by surgical excision
- grade II—slow-growing but infiltrative, recurring after surgery
- grades III and IV—show typical features of malignancy, with mitotic activity, invasion of the adjacent normal brain, and occasionally distant spread
- overall, 50% of gliomas are grade IV glioblastoma multiforme (GBM)—typically areas of prominent abnormal vascularity, haemorrhage, and necrosis.

Although imaging may be diagnostic of some 1° CNS tumours, in most cases, it offers only a differential diagnosis. Precise histological diagnosis is desirable to direct appropriate management. However, for many patients, this is not possible, either due to hazardous tumour location (e.g. brain-stem) or poor performance status. In these cases, a presumptive diagnosis is made on clinical and radiological findings.

### **Clinical presentation**

Tumours of the CNS can present with a wide range of physical, cognitive, and psychological symptoms.

Intracranial tumours tend to present either with neurological dysfunction or with symptoms and signs of raised ICP, depending on their location within the brain. Presentation with epilepsy or a slow onset of symptoms carries a relatively favourable prognosis. The frequency of symptoms in patients with intracranial glioma is shown in Table 22.5. High-grade gliomas are typically associated with considerable oedema in the surrounding normal brain, and this contributes significantly to pressure symptoms. Symptom relief may be obtained through reduction of cerebral oedema by the introduction of steroids, e.g. dexamethasone 8–16mg daily, with PPI gastroprotection, prior to biopsy or craniotomy. Maintenance of symptom control can often be achieved with a reduced dexamethasone dose (2–4mg daily), with reduced side effects.

Pituitary tumours may present with a visual field defect due to the close proximity of the pituitary gland to the optic chiasm. The clinical features of pituitary tumours also correlate with the amount and type of hormone secreted.

Spinal cord tumours are likely to present with focal neurological symptoms related to compression or invasion of nerve roots or the cord itself. A common presenting symptom is pain along a nerve root. As the commonest 1° cord tumours are slow-growing, the onset of symptoms may be insidious.

Skull base tumours may cause specific symptoms such as cranial nerve palsies and difficulty with balance or hearing. Of note, the most commonly occurring tumour at this site is schwannoma.



Table 22.5 Presenting symptoms in patients with intracranial glioma

Symptom	Frequency as principal presenting symptom (%)	Overall frequency at presentation (%)
Seizures	30	53
Headache	25	71
Cognitive distance	12	52
Motor disturbance	8	43
Speech disturbance	5	27
Clouding of consciousness	4	25
Visual disturbance	4	25
Sensory change	2	14
Miscellaneous	10	

## Investigations and staging

Investigation and management of all patients with a suspected 1° CNS tumour should be coordinated by a neuro-oncology MDT.

Investigation is dominated by CNS imaging:

- CT—contrast-enhanced CT of the brain is readily available and frequently adequate to demonstrate CNS tumours. However, CT may miss early tumours, especially in the temporal lobes and posterior fossa
- MRI—full-sequence scanning with gadolinium enhancement provides maximal tumour resolution in structural imaging
- functional imaging with SPECT, PET, and MR are gaining importance in both the diagnosis and assessment of response to treatment:
  - imaging agents thallium-201 and 123I-tyrosine in SPECT scanning
  - <sup>18</sup>F-FDG in PET can give important insights into the functional activity of the tumour, albeit hindered by high background activity in the grey matter
  - can aid the differentiation between high- or low-grade neoplasms and treatment-induced necrosis.
- tumours that spread via CSF pathways require whole neuraxis MRI (e.g. medulloblastoma, ependymoma).

Histological confirmation of the diagnosis should ideally be obtained in all cases. Methods of biopsy include:

- stereotactic biopsy
- neuroradiologically guided needle biopsy
- craniotomy and excision or debulking of the tumour
- endoscopic biopsy (minimally invasive technique, allowing direct visualization of intraventricular tumours)
- electrophysiologically guided resection (performed under local anaesthetic, this allows sparing of brain tissue involved in critical functions, thereby minimizing disability following surgery).

Other investigations are guided by initial findings:

- angiography (for surgical planning of spinal tumours)
- lumbar puncture and CSF cytology (medulloblastoma, ependymoma, germ cell tumour)
- HIV status (1° CNS lymphoma)
- ophthalmology review (1° CNS lymphoma)
- assessment of pituitary function (pituitary tumour)
- serum/CSF tumour markers (germ cell tumour)
- molecular genetics, e.g. 1p,19q deletion and O<sup>6</sup>-methylguanine-DNA methyl transferase (MGMT) expression, predict increased chemosensitivity in oligodendrogliomas.

The dominant prognostic factors for brain tumours are a combination of the histological type and clinical features such as age and performance status. Spread to regional lymph nodes and blood-borne spread to distant sites are rare in the majority of pathologies. Therefore, staging systems that are commonly used for other tumour types are rarely used for brain tumours.



## Treatment of primary central nervous system tumours

### Multidisciplinary management

Patients with CNS tumours suffer from a wide variety of related physical, cognitive, and emotional problems. Prominent are:

- movement disorders
- tumour-associated epilepsy
- pain (headache)
- speech disorders
- intellectual decline
- personality changes.

These are best managed jointly between 1° care and a hospital neuro-oncology MDT, including a neurosurgeon, neuro-oncologist, neurologist, nurse specialist, and rehabilitation team, whose goals are to maximize the QoL, as well as to improve survival. Early involvement of the specialist palliative care team can be valuable in patients with high-grade glioma.

### Low-grade glioma (WHO grades I and II)

- Histological diagnosis is preferred, where possible, as up to 40% of radiologically diagnosed low-grade gliomas have high-grade features histopathologically.
- Initial management is usually immediate surgery or watchful waiting.
- Immediate surgery is indicated if there is a large mass and/or extensive neurological symptoms in patients in whom resection is technically feasible.
- Watchful waiting may be appropriate for small, minimally symptomatic tumours:
  - low-grade astrocytoma, presenting with epilepsy alone with no mass effect on imaging, may be managed for years with anticonvulsants, with only regular review and repeat scanning required
  - intervention (surgery or radiotherapy) may be indicated if new neurological symptoms develop or radiological evidence of mass effect, tumour growth, or transformation to high-grade tumour.
- EORTC criteria can help identify patients with poor prognostic features, who may benefit from early intervention. These are:
  - age >40y
  - largest tumour diameter >6cm
  - tumour crossing the midline
  - astrocytoma histology
  - presence of neurological deficit.
- Radiotherapy is used for:
  - persistent neurological symptoms and significant residual tumour after surgery
  - tumour regrowth after surgery
  - evidence of tumour progression to high grade
  - symptomatic unresectable tumour.

- Radiotherapy improves survival, whether it is given initially or for progressive disease. Early post-operative radiotherapy may, however, provide an improvement in disease-free survival in patients with good performance status.
- The role of chemotherapy as first-line treatment is unclear.
- Chemotherapy does have benefit in the treatment of relapsed or progressive disease post-radiotherapy.

### High-grade glioma (WHO grades III and IV)

- Includes GBM, anaplastic astrocytoma, anaplastic oligodendroglioma, and anaplastic ependymoma.
- Age and performance status are strong determinants of survival.
- The main aims of treatment are to maximize the patient's QoL and improve survival, where possible.
- Role of surgery:
  - surgery alone is not curative
  - for rapid relief of pressure symptoms (emergency decompression or shunt insertion for hydrocephalus)
  - elective surgery for fit patients for biopsy and tumour debulking
  - maximal tumour debulking improves survival and provides tissue for histology
  - re-operation is occasionally appropriate for relapsed disease, although the indications for this are not firmly established (may be more appropriate, e.g. for frontal lobe tumours with pressure symptoms)
  - advances in surgery, which include MRI-guided neuro-navigation, intraoperative MRI, functional MRI, intraoperative mapping, and fluorescence-guided surgery, have improved the extent and safety of resection
  - patients with diffuse brainstem tumours are not amenable to surgery, but, if the lesion is local, resection (if possible) is the treatment of choice, usually via a posterior fossa approach. Surgical morbidity can be high.
- The mainstay of treatment is radiotherapy:
  - radical radiotherapy should be restricted to younger patients (commonly maximum 60–70y) with good performance status (WHO 0–1)
  - palliative radiotherapy may be appropriate for younger patients of PS 2–3, or older patients of PS 0.
- Concurrent radical radiotherapy and temozolomide chemotherapy, followed by adjuvant temozolomide chemotherapy, have been shown to improve the 2y survival to 26%, compared to 10% in those who did not receive chemotherapy.
- Chemotherapy also of benefit in the treatment of relapsed disease.
- Regardless of age, patients of poor performance status may not benefit from any treatment and should be offered supportive care.

### Ependymoma

- Arises from ependymal cells lining the ventricular system and the central canal of the spinal cord to the filum terminale.

- Safe resection of all of the tumour is the optimal 1° treatment.
- Residual tumour carries poor prognosis.
- Low-grade tumours treated by surgery and local radiotherapy.
- Anaplastic tumours require additional craniospinal irradiation (CSI).

### **Pineal tumours**

- Hydrocephalus, due to blockage of the third ventricle, is common, requiring shunt insertion/surgical decompression, prior to surgical excision, or debulking. At least a biopsy is essential for optimum management. Stereotactic biopsy or an open microsurgical procedure requires careful discussion at a multidisciplinary meeting. The former gives rise to fewer complications, but the latter removes maximal tumour burden and may improve prognosis.
- Pineocytoma is treated by surgery and radiotherapy. Stereotactic radiotherapy may be used for low-grade tumours.
- Pineoblastoma requires CSI.

### **Meningioma**

- Management depends on signs, symptoms, patient fitness, and the size and site of the tumour.
- Watchful waiting may be appropriate (small incidental tumour in an asymptomatic patient).
- Surgery is the mainstay of treatment, although complete excision may be difficult, as some are very vascular and/or may be in inaccessible areas. Total excision (Simpson grade I) is ideal, but probably unusual in practice. Total excision for meningiomas involving the cavernous sinus, petroclival region, posterior aspect of the superior sagittal sinus, and optic nerve sheath is not possible without major neuropathic morbidity. Most convexity and spinal meningiomas can be excised, with minimal morbidity.
- Indications for radiotherapy:
  - radical 1° treatment
  - tumour at inoperable location (cavernous sinus, optic nerve).
- Radical post-operative treatment:
  - invasion by the tumour of an adjacent critical structure
  - WHO grades II/III tumour
  - unresectable recurrence.
- Stereotactic radiotherapy and radiosurgery may be useful in selected cases.

### **Germ cell tumours**

#### *Germinoma*

- The standard treatment is radical radiotherapy.
- The role of chemotherapy is unclear.
- Urgent radiotherapy may be necessary to prevent blindness due to the predilection of germinomas for the optic chiasm and suprasellar cistern.

#### *Non-germinoma*

- Chemotherapy first line.
- Surgery if residual tumour in selected cases.
- Radiotherapy to the 1° site.

## Pituitary tumours

### *Pituitary adenoma*

- Macroprolactinoma:
  - dopamine agonist therapy, e.g. bromocriptine first line
  - surgery
  - post-operative radiotherapy to residual tumour.
- Microprolactinoma:
  - treat only if symptomatic
  - dopamine agonist therapy, e.g. bromocriptine first line
  - surgery
  - post-operative radiotherapy if high preoperative prolactin fails to normalize post-operatively, or locally invasive tumour.
- Functionless tumour:
  - surgery
  - post-operative radiotherapy to reduce local recurrence.
- Acromegaly/gigantism:
  - surgery
  - post-operative radiotherapy to reduce local recurrence
  - bromocriptine if high GH post-operatively, or surgery not possible
  - octreotide for refractory GH-secreting adenoma.

### *Craniopharyngioma*

- Surgical resection.
- Post-operative radiotherapy if subtotal resection.

Surgery for pituitary tumours is usually via the trans-sphenoidal route. Most microadenomas and many macroadenomas can be resected via the trans-sphenoidal route. Endoscopic trans-sphenoidal approaches are increasingly used in specialized centres.

## Primary central nervous system lymphoma

- Chemotherapy is the mainstay of treatment:
  - adjuvant radiotherapy if partial response to chemotherapy
  - role of radiotherapy after complete response unclear.
- In AIDS patients, antiretroviral therapy and cranial radiotherapy may modestly improve an otherwise dismal prognosis.

## Acoustic neuroma (vestibular schwannoma)

- Often associated with neurofibromatosis—patients may have other tumours; therefore, management may be complex.
- Treatment required only if disease progression.
- Treatment options are surgery or radiotherapy.

### *Surgery*

- Should be curative if complete excision with microsurgical techniques.
- Hearing loss was previously inevitable, but selected patients may preserve hearing with a partial labyrinthectomy.
- After failure of 1° radiotherapy.
- Surgical risks include:
  - CSF leaks
  - meningitis

- headache
- hearing loss
- facial nerve paralysis.

### Radiotherapy

- Single-fraction stereotactic radiosurgery (SRS).
- Fractionated stereotactic radiotherapy (FSRT).

### Medulloblastoma

- Is predominantly a tumour of childhood and is very rare in adults.
- Usually occurs in the posterior fossa, presenting with cerebellar symptoms and raised ICP, and commonly spreads through the craniospinal axis.
- Management and prognosis are guided by staging, using modified Chang criteria, based on the extent of the disease (see Table 22.6):
  - standard-risk disease is T1–3a, M0, and no residual disease after surgery
  - high-risk disease is T3b–4, any M+, or post-operative residual disease.
- Combined-modality treatment, including maximal surgical resection, tumour bed irradiation and CSI, and chemotherapy, is standard of care:
  - standard-risk disease is treated with CSI with boost to the tumour bed, followed by chemotherapy
  - high-risk disease is treated with chemotherapy prior to radiotherapy, with maintenance chemotherapy if M1–3 disease.
- As clinical experience in adults is limited, treatment should be patterned after that in children.
- Analysis of transcriptional profiles has identified four distinct molecular variants of differing prognosis—Wnt (wingless), SHH (sonic hedgehog), and groups C and D—and it is hoped that less toxic treatment will result in successful management of Wnt and SHH variants, and more targeted therapy may improve the poorer prognosis of the latter groups.

### Spinal cord tumours

#### *Schwannomas and meningiomas*

- Usually amenable to complete resection, with high rates of local control.
- Inoperable/recurrent disease treated with radical radiotherapy.
- High-grade tumours usually treated with post-operative radical radiotherapy.

#### *Ependymoma*

- Gross total resection improves survival.
- Post-operative radiotherapy given if subtotal resection or anaplastic pathology.

#### *Glioma*

- Standard treatment is resection, followed by post-operative radiotherapy for low- and high-grade tumours.
- No survival benefit for gross total resection over subtotal resection.
- Higher radiotherapy dose for high-grade tumours.



**Table 22.6** Modified Chang system for staging of medulloblastoma

Extent of tumour	Metastatic spread
T1, <3cm in diameter	M0, no evidence of metastases
T2, >3cm in diameter	M1, microscopic tumour cells in the CSF
T3a, >3cm in diameter, with extension into the aqueduct of Sylvius and/or the foramen of Luschka	M2, macroscopic tumour seeding in the cerebellar/cerebral subarachnoid space or in the third or lateral ventricles
T3b, >3cm in diameter, with extension into the brainstem	M3, macroscopic tumour seeding in the spinal subarachnoid space
T4, >3cm in diameter, with extension above the aqueduct of Sylvius and/or below the foramen magnum	M4, metastases outside the cerebrospinal axis

## Radiotherapy for primary central nervous system tumours

### Radical radiotherapy

Treatment should be 3D conformal, and the principles of treatment are the same, regardless of the tumour type.

#### *Patient position*

- Depends on the tumour location.
- Supine has the advantage of patient comfort.
- Prone for posterior lesions.

#### *Patient immobilization*

- Perspex® or thermoplastic shell immobilization allows accurate reproducibility, essential for radical treatment planning, given the close proximity of critical normal structures (e.g. lens, optic chiasma, brainstem, spinal cord).

#### *Volume localization*

- CT planning scan.
- Co-registered with preoperative CT or MRI, if possible.
- GTV defined on each slice, with margin to create CTV, and PTV, dependent on the tumour type (see Table 22.7), edited to avoid organs at risk (OARs).
- OARs outlined.

#### *Dose fractionation*

(See Table 22.7.)

- Fraction size 1.8–2.0Gy to minimize late radiation damage.
- Attention to dose tolerances of OARs (see Table 22.8).
- The tumour dose reflects the balance of probability of tumour control against the risk of late radiation damage.

### Palliative radiotherapy

Palliative radiotherapy is appropriate for young glioma patients of PS 2–3 or older patients of PS 0. In these patients, palliative radiotherapy may help symptom control. However, life expectancy is short, regardless; therefore, treatment duration and toxicity should be kept to a minimum. Examples of radiotherapy schedules include 30Gy/six fractions/2wk and 40Gy/15 fractions/3wk.

### Craniospinal irradiation

CSI is a complex technique which should only be attempted in radiotherapy centres with clinicians, physics, and radiographer staff experienced in its delivery.

- Traditionally, in most centres, patients have been treated in the prone position, but supine positioning is now increasingly used to improve patient comfort and stability.
- Immobilization is crucial; a Perspex® or thermoplastic shell for the head/neck and body immobilization may also be used, e.g. vac-bag and foot stocks. The CTV is the intracranial and spinal meninges, preferably outlined on a planning CT scan of the head and spine.

- The field arrangement is usually lateral, opposed cranial fields, with usually two posterior fields in adults carefully matched to the lower border of the cranial fields.
- To avoid the risk of overdosing or underdosing at the spinal field junctions, moving junctions are used.

Table 22.7 Details of radiotherapy planning for 1° CNS tumours

Tumour type	GTV to CTV margin (GTV is 1° tumour prior to any intervention) (cm)	Dose/fractionation (Gy/fractions)
<b>Glioma</b>		
High-grade	2.5	60/30
Low-grade	1.5	54/30
Medulloblastoma	2.5	55/33 (+ CSI 35/21)
Ependymoma	1.5–2.5	50–54/30–33 (+ CSI 35/21 if anaplastic)
Pineocytoma	0.5	45–50/25
<b>Meningioma</b>		
High-grade	1.5–2.5	50–55/30–33
Low-grade	0.0–0.5	50–55/30–33
Germinoma	1.0–2.0	40/24 (+ CSI 25/15)
<b>Pituitary</b>		
Adenoma	0.5	45/25
Craniopharyngioma	0.5	50/30
1° CNS lymphoma	2.5	45/25

NB CTV to PTV margin, using a Perspex® or thermoplastic head shell, is usually ~0.5cm.

Table 22.8 Normal CNS tissue tolerance doses

Structure	Tolerance dose (Gy, 2Gy/fraction)
Brain parenchyma	54–60
Brainstem	48
Optic nerves and chiasm	50–55
Pituitary gland/hypothalamus	40–60
Middle/inner ear	60
Lacrimal gland	20
Lens	6–10
Retina	50

**Stereotactic radiotherapy**

SRS is a highly specialized technique available in a limited number of cancer centres. It focuses high doses of radiation to a tumour in a single fraction, sparing normal tissues by limiting its use to small tumours and treating with minimal margins around the GTV. This technique is most widely used for acoustic neuroma.

FSRT is planned in a similar way to radical radiotherapy. The difference is that high-precision immobilization in a relocatable stereotactic frame means that no CTV to PTV margin is required. The margin to PTV with stereotactic immobilization should be in the region of 0.2–0.3mm. This allows sparing of nearby critical normal structures. This technique is most commonly used for the treatment of acoustic neuroma, treating to a dose of 50–54Gy/30 fractions. It has also been used in the management of skull base meningioma and solitary intracranial metastases.

The advantage of these techniques for the treatment of acoustic neuroma is hearing preservation, compared to surgery. FSRT has slightly better reported hearing preservation rates, compared to SRS, of 85% and 75%, respectively.

**Central nervous system radiotherapy side effects**

The common side effects of CNS radiotherapy are shown in Table 22.9.

**Table 22.9** Side effects of brain and spinal irradiation

Radiotherapy site	Acute toxicity	Late toxicity
Brain	Alopecia	Pituitary hypofunction
	Skin reaction	Optic chiasm damage
	Fatigue	Risk of second malignancies (brain)
	Nausea and vomiting	Neurocognitive impairment
		Memory loss
Spine	Sore throat	Risk of second malignancy (chest/abdomen/pelvis)
	Nausea and vomiting	Ovarian failure
	Diarrhoea	Spinal cord damage
	Myelosuppression	

## Chemotherapy for primary central nervous system tumours

Most CNS tumours are traditionally considered poor targets for chemotherapy:

- many, e.g. gliomas, demonstrate intrinsic chemoresistance to most conventional cytotoxics
- the blood–brain barrier normally provides an obstacle to drugs, except lipophilic agents
- however, the blood–brain barrier is disrupted in many 1° CNS tumours (as demonstrated by contrast uptake on axial imaging), allowing the penetration of chemotherapy.

The current indications for chemotherapy in 1° CNS tumours include:

- in selected fit patients with GBM, concomitant radical radiotherapy and oral temozolomide chemotherapy ( $75\text{mg}/\text{m}^2$  daily), followed by six cycles of post-radiation therapy oral temozolomide ( $200\text{mg}/\text{m}^2$  for 5 days of a 28-day cycle)
- for relapsed glioma (low-grade and high-grade), examples of chemotherapy regimes are:
  - oral temozolomide ( $200\text{mg}/\text{m}^2$  for 5 days of a 28-day cycle until tumour progression)
  - PCV (1-(20-chloroethyl)-3-cyclohexyl-1-nitrosourea (lomustine),  $110\text{mg}/\text{m}^2$  PO on day 1 every 6wk, procarbazine  $60\text{mg}/\text{m}^2$  PO on days 8–21, vincristine  $1.4\text{mg}/\text{m}^2$  (max 2mg) IV on days 8 and 22)
  - single-agent lomustine 200–240mg PO on day 1, 6-weekly
- intraoperative carmustine implants are licensed for the treatment of patients with newly diagnosed high-grade glioma, in whom >90% of the tumour has been resected
- anaplastic oligodendrogliomas benefit from adjuvant PCV chemotherapy, with particular improvement in the survival of patients with 1p/19q co-deletion
- the agents used in the management of medulloblastoma include cisplatin, vincristine, and cyclophosphamide
- the agents used in the management of non-germinoma are bleomycin, etoposide, and cisplatin.

## Prognosis for primary central nervous system tumours

The prognosis varies widely, depending on the tumour type (see Table 22.10). The OS of patients with high-grade glioma remains fairly dismal. However, some tumours, e.g. pituitary adenomas, may not affect the long-term survival at all. Overall, the 5y survival of malignant brain tumours is ~17%.

**Table 22.10** Prognosis of 1° CNS tumours

Tumour type	Prognosis
<b>High-grade glioma</b>	
Anaplastic astrocytoma	Surgery only: MS 1y Surgery + RT: MS 3y
Glioblastoma	Surgery only: MS 3mo Surgery + RT: MS 10mo Surgery + chemoRT: MS 14.6mo
<b>Low-grade glioma</b>	MS >5y
<b>Medulloblastoma</b>	
Standard-risk disease	5YS 70%
High-risk disease	5YS 20–50%
<b>Ependymoma</b>	
Low-grade	5YS 30–50%
High-grade	5YS 0%
Pineocytoma	5YS 85%
<b>Meningioma</b>	
Grade I	RR 7–20%
Grade II	RR 29–40%
Grade III	RR 50–78%
<b>Germ cell tumours</b>	
Geminoma	5YS >90%
Non-germinoma	5YS 60%
<b>Pituitary tumours</b>	
Adenoma	5YS >95%
Craniopharyngioma	10YS 85%
1° CNS lymphoma	5YS 30%
Acoustic neuroma	SRS: 5YLCR 92% FSRT: 5YLCR 98%

chemoRT, chemo-radiotherapy; MS, median survival; RR, recurrence rate; RT, radiotherapy; 5YLCR, 5y local control rate; 5YS, 5y survival; 10YS, 10y survival.

Predictors of outcome for patients with glioma include:

- the tumour grade:
  - the most important predictor
  - low-grade gliomas have a relatively good prognosis
  - the results of treatment of high-grade gliomas remain poor
- the extent of surgical excision
- the age (worse survival >50y)
- the performance status at presentation
- the presence of fits confers better prognosis
- a low score correlates with poor prognosis
- mini-mental score (see Table 22.11).

Table 22.11 Mini-mental test

Maximum score	Patient's score	Questions
5		What is the time and date (time, day, date, month, year)?
5		Where are we now (ward, hospital, town, county, country)?
3		Examiner names three unrelated objects and asks the patient to repeat these
5		Subtract serial 7s from 100, or spell 'WORLD' backwards
3		Ask the patient to recall the same three objects
2		Ask the patient to name two simple objects, e.g. watch and pen
1		Ask the patient to repeat 'no ifs, ands, or buts'
3		Give the patient a piece of paper, and ask him/her to take the paper in their right hand, fold it in half, and put it on the floor
1		Give the patient written instruction, and ask them to follow them, e.g. 'close your eyes'
1		Ask the patient to make up and write one sentence
1		Ask the patient to copy a diagram of intersecting pentagons
30		Total

A score of 10–20 shows moderate impairment, and 0–10 severe impairment.

## **Recent advances and future treatments for primary central nervous system tumours**

- Surgical neuronavigation:
  - recently acquired images of the patient's brain are projected intraoperatively on to the operating field
  - facilitates accurate laser or ultrasound resection of the tumour.
- Radiotherapy—improved accuracy, and dose escalation is feasible with stereotactic localization, although results so far disappointing in high-grade glioma. IMRT can undoubtedly facilitate the dose escalation and sparing of normal tissues but has yet to prove any survival benefit.
- Novel therapies under evaluation include:
  - TKIs
  - farnesyl transferase inhibitors
  - EGFR inhibitors
  - VEGF inhibitors and other anti-angiogenesis inhibitors.
- Gene therapy:
  - much attention has focused on the *HSV-tk/aciclovir* suicide gene system
  - other therapeutic strategies are possible, but the lack of effective vectors currently limits the applicability of this approach
  - using adenovirus or herpes simplex virus (HSV) might overcome the limitations inherent in the current retroviral approaches.





## Brain metastases

### Epidemiology

Metastases to the brain from an extracranial 1° are common—at least ten times more common than 1° CNS tumours:

- symptomatic metastases have an incidence of around 6 per 100 000
- autopsy studies have revealed an overall occurrence in 24% of patients with known cancer
- found in 40% of patients with systemic cancer at post-mortem
- slight ♂ preponderance, and the incidence increases with age.

The incidence of brain metastases is rising, in part due to improvements in, and the availability of, brain imaging, but also due to better control of extracerebral malignancy as a result of improved local and systemic therapy:

- breast cancer, especially lung metastases and/or HER2-positive (trastuzumab does not cross the blood–brain barrier)
- colorectal cancer—prolonged survival with advanced disease through effective systemic treatment
- NSCLC—improved loco-regional therapy and axial imaging.

Whilst brain metastases may arise from any 1° site, the commonest are from:

- lung cancer (50%)
- breast cancer (15%)
- melanoma (10%)
- renal cancer
- GI cancer
- unknown 1° (10%).

Some cancers that commonly metastasize to other organs rarely involve the brain, e.g. prostate, bladder, cervix, and ovary. The reason for this is not clear. Rare tumours that have a predilection for the brain include choriocarcinoma and malignant germ cell tumours with trophoblast elements.

Carcinomatous meningitis is less common but may occur in:

- lung cancer
- breast cancer
- leukaemia and lymphoma.

### Pathology

The histology reflects the original 1° tumour. Vascular proliferation and tumour necrosis are common features. There is often a demarcation from the adjacent brain:

- 30% single
- 80% cerebral hemispheres, 15% posterior fossa, 5% brainstem
- different tumours have a predilection for metastases to different areas of the brain:
  - pelvic and GI tumours more commonly metastasize to the posterior fossa
  - SCLC equally distributed in all areas of the brain.
- commonly, considerable cerebral oedema adds to the mass effect of metastases.

## Presentation

The presentation of brain metastases is similar to that of 1° brain tumours:

- headache
- focal neurological deficit, e.g. loss of power, dysphasia, visual field defect
- confusion or personality change
- seizures—focal or generalized
- ataxia
- with the additional features of systemic malignancy, if other organs involved.

## Investigations

Imaging is most commonly with contrast-enhanced CT of the brain because of its availability. However, the most sensitive investigation is high-resolution contrast-enhanced MR scan:

- metastases most frequently appear as multiple, discrete, well-demarcated lesions
- hypointense on  $T_1$
- hyperintense on  $T_2$
- marked gadolinium enhancement
- often considerable associated vasogenic oedema
- up to 20% of lesions revealed on MRI are not seen on CT.

In patients who present with brain metastases, with no previous diagnosis of cancer, a detailed history and examination can identify the 1° in ~30%. Subsequent investigations may include CXR, CT of the chest/abdomen/pelvis, PET-CT, and biopsy; 60% will have a 1° lung cancer or concomitant pulmonary metastases. Other frequent unknown 1° cancers include melanoma, breast, and colorectal, with the 1° unidentified in 25–30%.

## Management

Management includes:

- symptom control
- specific treatment directed against the brain metastases
- systemic treatment.

Appropriate management is guided by an assessment of the prognosis. Several studies have assessed the prognostic features in patients with brain metastases (see Table 22.12). Patients of intermediate prognosis fall into the favourable- or poor-prognosis group, depending on the likelihood of controlling systemic disease. For the third group, appropriate management comprises steroids and symptom control.

### *Symptom control*

Control of symptoms similar to 1° brain tumours:

- dexamethasone in the majority of patients
- frequently produces a reversal of symptoms and neurological deficit
- starting dose of 8–16mg daily, along with PPI gastroprotection.
- improvement can often be maintained with doses of 2–4mg.

### *Treatment directed against brain metastases*

For patients with multiple brain metastases, with favourable prognostic characteristics at presentation, or patients improved following

dexamethasone, treatment with palliative radiotherapy can be offered, with the following aims:

- temporary tumour control
- modest improvement in the survival time
- reduction in the steroid dose without deterioration in symptoms (reducing problems of candidiasis, proximal myopathy, and cushingoid appearance).

Typically, the whole brain is irradiated. A dose of 20Gy in five fractions has been shown to be as effective as any of the more protracted fractionation schemes.

For patients presenting with solitary or a small number of brain metastases:

- defined as metastatic disease within the brain, in the absence of demonstrable malignancy elsewhere in the body
- biopsy may be required, especially when there is no history of previous cancer
- In patients with favourable prognostic features:
  - surgical excision should be considered
  - post-operative whole-brain radiotherapy is given (20Gy in five fractions or 30Gy in ten fractions), with or without a local boost
  - an alternative to surgery is SRS (20Gy in a single fraction), with consideration given to subsequent whole-brain irradiation.

### *Systemic treatment*

Whilst many cytotoxics do not cross the blood–brain barrier, this barrier is disrupted in many patients with CNS metastases. Chemotherapy may be useful in chemosensitive tumours:

- germ cell tumours
- SCLC
- breast cancer.

### *Targeted therapies under investigation*

- Lapatinib.
- Bevacizumab.

### **Outcome**

Overall, the prognosis is poor for patients with brain metastases from the common cancers. For patients with poor prognostic features, the median survival is 6–8wk, irrespective of treatment. Patients with ‘favourable-prognosis’ solitary metastases that are treated with surgery and radiotherapy have a median survival of ~10mo.

**Table 22.12** Predicting prognosis in brain metastasis

Prognosis	Characteristics
1, favourable	KPS >70 Age <65y Controlled 1° No extracranial metastases
2, intermediate	KPS >70 With 1+ of: age >65y; uncontrolled 1°; extracranial metastases
3, poor	KPS <70

KPS, Karnofsky performance status score.

## Further reading

- Akay KA, Izci Y, Baysefer A (2004). Surgical outcomes of cerebellar tumours in children. *Pediatr Neurosurg* **40**, 220–5.
- Bhagavathi S, Wilson J (2008). Primary central nervous system lymphoma. *Arch Pathol Lab Med* **132**, 1830–4.
- Bruce JN, Ogden AT (2004). Surgical strategies for treating patients with pineal region tumours. *J Neurooncol* **69**, 221–36.
- Davies E, Hopkins A (eds.) (1997). *Improving care for patients with malignant glioma*. London: Royal College of Physicians.
- Henry RG, Berman JJ, Nagarajan SS, Mukherjee P, Berger MS (2004). Subcortical pathways serving cortical language sites: initial experience with diffusion tensor imaging fiber tracking combined with intraoperative language mapping. *Neuroimage* **21**, 616–22.
- Recinos PF, Sciubba DM, Jallo GI (2007). Brainstem tumors: where are we today? *Pediatric Neurosurg* **43**, 192–201.
- Wen PY, Kesari SL (2008). Malignant gliomas in adults. *N Engl J Med* **359**, 492–507.
- Whittle IR, Smith C, Navoo P, Collie E (2004). Meningiomas. *Lancet* **363**, 1535–43.



# Skin cancers

Introduction 524

Malignant melanoma 526

Management of malignant melanoma 532

Management of metastatic disease 536

Intra-ocular melanoma 540

Mucosal melanoma 541

Non-melanoma skin cancer 542

Merkel cell carcinoma 547

Further reading 548

## Introduction

- Skin cancers constitute the commonest group of cancers in the UK (20% of all cancer registrations).
- The incidence of new cases registered annually in the UK is felt to under-represent the true incidence, due to differing practices for registering cases (NICE).
- The management of this group of cancers may be coordinated in the community, at the local hospital, or in a specialist centre, depending on the diagnosis and stage. However, it is recommended that any health professional involved in the treatment of any type of skin cancer should be a member of the appropriate MDT.





## Malignant melanoma

1° cutaneous malignant melanoma arises from the melanocytes found in the basal layer of the skin, which produce melanin pigment and are responsible for the tanning response after UV radiation exposure.

### Epidemiology and aetiology

- Incidence rates in the UK are rising faster than for any other of the current ten commonest cancers:
  - fifth commonest cancer in the UK, with around 12 800 new cases diagnosed annually (Office for National Statistics, June 2012)
  - more women than men are diagnosed with melanoma in the UK, although death from melanoma is commoner in men
  - the incidence increases with age
  - the lifetime risk of developing melanoma in the UK is currently estimated at around 1:60 (CRUK Statistical Information Team, 2011) but is probably as low as 1:1200 amongst those with pigmented skin
  - the increased incidence may be due to:
    - greater public awareness and increased surveillance
    - earlier detection
    - changes in diagnostic criteria
    - increased sun exposure (holidays abroad commoner)
    - rates in Australia are the highest in the world and continue to double each decade.
- Sunlight:
  - main environmental cause of melanoma
  - excess exposure to UV radiation (especially UV-B), a history of severe sunburn, or intense intermittent UV exposure, particularly in childhood/adolescence, are strongly associated with subsequent risk of developing melanoma
  - the majority of melanomas develop within sun-exposed areas
  - artificial exposure to UV-A radiation (especially sunbeds, but also psoralen UV-A (PUVA) therapy) has contributed to the increased incidence of melanoma over recent years.
- Genetic risk:
  - ~10% of cases will have a strong family history of melanoma. Certain syndromes associated with a markedly elevated risk of developing malignant melanoma have been characterized, e.g. familial atypical multiple mole and melanoma (FAMM) syndrome, dysplastic naevus syndrome
  - a melanoma susceptibility gene *CDKN2A* on chromosome 9p21.3 has been identified as a tumour suppressor gene (mutated in FAMM)
  - it is likely that multiple genes will eventually be implicated in the development of melanoma
  - germline mutations are implicated in up to 40% of patients with familial melanoma and may have a role in sporadic cases.
- Benign pigmented naevi (see Fig. 23.1 and Fig. 23.2):
  - some may be precursor lesions to malignant disease
  - more frequently these are markers of a more general increased risk within the individual.

- Immunosuppression:
  - e.g. following organ transplantation
  - appears to be associated with an increased risk of developing melanoma
  - conversely, there is currently no evidence that melanoma is more prevalent in the HIV-positive population.

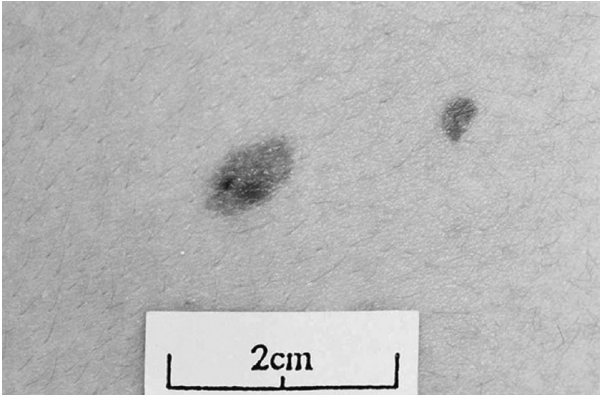

Fig. 23.1 Benign pigmented lesion (see also colour plate section).

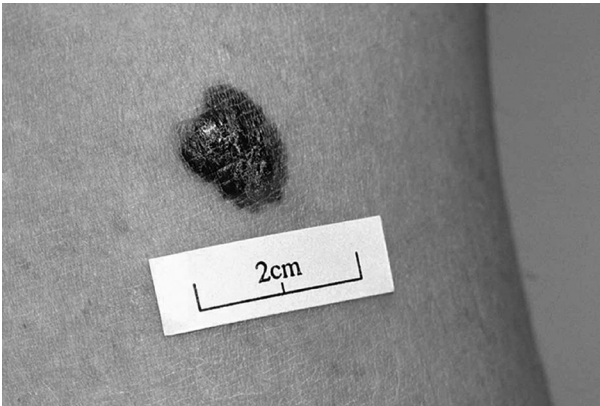

Fig. 23.2 Benign naevus close-up (see also colour plate section).

**Screening and prevention**

- Strenuous efforts must be made to minimize the occurrence of melanoma and to maximize the chances of early diagnosis, whilst curative treatment remains possible.
- The priority for screening must be to identify those patients most at risk.
- A past history of melanoma is a strong risk factor for a subsequent 1° cutaneous melanoma. Up to 10% of patients will develop a second melanoma within 5y. Previous non-melanoma skin cancer is also a risk factor.
- Screening may be an appropriate option for patients deemed at particular risk of the disease, e.g. those with a strong family history of melanoma or with a personal history of any skin cancer or of blistering sunburn in early life.
- Serial photographs can be useful in patients with a high mole burden, as can inspection via a magnifying dermatoscope.
- Exposure to sunlight has been identified as the major modifiable risk factor. This has led to public health drives to promote sun avoidance, including:
  - the successful Australian 'Slip (on a shirt), Slap (on a hat), Slop (on sunscreen)' campaign
  - the promotion of artificial tanning products as an acceptable cosmetic alternative to UV exposure
  - the introduction of sun hats as part of the uniform in some schools.

**Malignant melanoma: clinical presentation**

Typically present with (see Box 23.1):

- an alteration in a pre-existing pigmented mole on the skin
- a new pigmented lesion—this is particularly relevant if aged  $\geq 40$ y, when the acquisition of new moles is uncommon
- irregular brown/black pigmentation of a lesion
- irregular border or new asymmetry of a lesion
- $\pm$  oozing, crusting, itching, or bleeding
- differential diagnosis:
  - benign melanocytic naevi
  - seborrhoeic keratoses (older ages).

Less commonly:

- palpable regional lymphadenopathy
- metastatic disease to the viscera (the 1° lesion may not be identified).

**Box 23.1 Warning signs of melanoma: ABCDE**

- **A**symmetry—one half different to the other.
- **B**orders—uneven, blurred, or scalloped.
- **C**olour—variety in the shade or colour.
- **D**iameter—usually, but not exclusively,  $>6$ mm.
- **E**volving—any change, sudden or continuous.

## Investigations

- Full clinical examination, including skin, regional and distant lymph node assessment, palpation of the abdomen, and neurological examination, if indicated.
- A correctly performed biopsy is a critical step:
  - excision biopsy required for any pigmented lesion of concern (see Fig. 23.3 and Fig. 23.4 for examples of cutaneous malignant melanoma)
  - complete excision, with normal skin margins, is optimal
  - this should provide sufficient information to confirm the diagnosis and provide valuable information to assist with staging (thickness, ulceration, mitotic rate), necessary further investigations, and likely prognosis
  - incision biopsies are only acceptable for large lesions in cosmetically sensitive areas (e.g. face)
  - punch and shave biopsies should not be done, as they do not permit complete histological staging.
- CXR and serum biochemistry, including LDH, once the diagnosis of melanoma has been confirmed.
- Restrict further imaging, e.g. CT of the chest/abdomen, to those patients with confirmed regional metastatic disease or clinical symptoms/signs suggestive of dissemination. This is because of the high false positive rate, following speculative imaging.

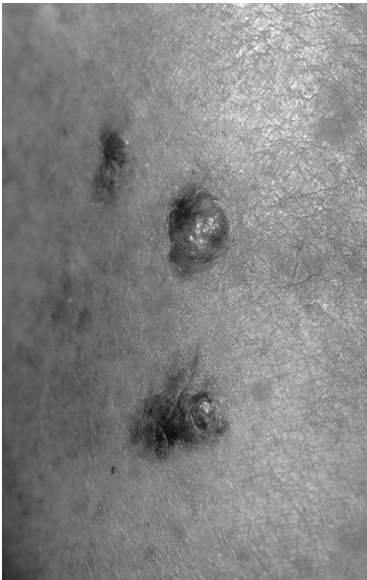

Fig. 23.3 Malignant melanoma close-up (see also colour plate section).

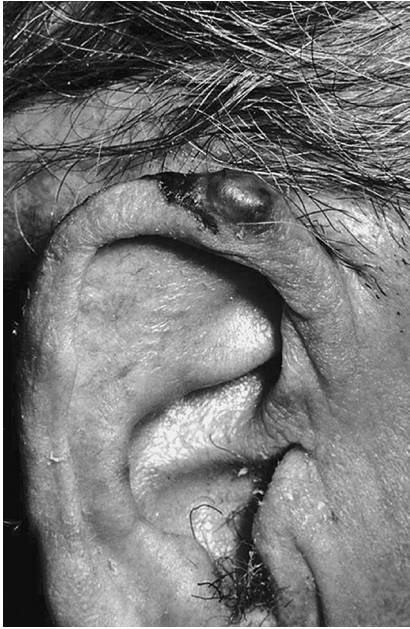



Fig. 23.4 Malignant melanoma close-up (see also colour plate section).

### Pathology

- Confirms neoplastic melanocytic cells invading beneath the basement membrane into the underlying dermis.
- Histological subtype, e.g. superficial spreading melanoma, nodular or acral lentiginous melanoma.
- Margins—whether involved or the width of normal tissue surrounding the melanoma. Identifies microsatellites of melanoma.
- Important to identify the histopathological features with prognostic implications:
  - the tumour (Breslow) thickness, measured from the epidermal granular layer to the base of the tumour at its thickest point, is the most important prognostic factor—increasing thickness correlates with a poorer prognosis. A thickness of  $>4.0\text{mm}$  is defined as T4
  - the mitotic rate is the second most important prognostic factor—increasing mitotic rate correlates with a poorer prognosis
  - the presence or absence of ulceration. Ulcerated  $1^\circ$  tumours have a worse prognosis than non-ulcerated tumours of the same thickness.

## Staging

The AJCC Staging 2010 has produced a revised validated staging system, based on the tumour thickness, mitotic rate, presence of ulceration, and identification of metastases, to provide guidance for management decisions and likely prognosis (see  <https://cancerstaging.org> to download the TNM staging).

## Management of malignant melanoma

### Surgical management

#### *Surgery at the primary site*

- The treatment for 1° malignant melanoma is complete excision of the lesion.
- The recommended margin of excision of normal skin varies, according to the thickness of the tumour:
  - *in situ* disease only—0.5cm
  - <2mm thick—at least 1cm
  - ≥2mm, but <4mm, thick—at least 2cm
  - ≥4mm—3cm margin recommended, although superiority of this over a more conservative excision not yet proven.
- Excision must be adequate in depth as well as laterally.
- Unusual sites of disease, e.g. foot sole, nail bed, require tailored surgical techniques.
- Most patients with 1° melanoma have the defect closed directly. A small number may require either a flap or graft to achieve closure.

#### *Surgery for the regional lymph nodes*

- One in five patients who are clinically node-negative will have metastatic deposits.
- False positive nodal assessment is probably equally as common.
- *Regional lymph node dissection* in patients with clinical evidence of lymph node involvement:
  - therapeutic lymphadenectomy of palpable or histologically proven metastatic lymph nodes may be curative, e.g. 10y DFS of ~25% for all node-positive patients treated surgically
  - lymph node dissection also minimizes the risk of local ulceration or fungation
  - complications, following surgery, are common and include infection and seroma formation in the short term, and lymphoedema in the longer term.
- *Elective lymph node dissection* in patients without definite evidence of regional nodal involvement:
  - more complex
  - has not been shown to improve survival in patients with tumours that are <1mm or ≥4mm thick. There is some suggestion of a survival benefit in younger patients with tumours of intermediate depth
  - the main benefit of establishing the status of regional lymph nodes is for accurate staging, provided this will not affect the options for subsequent adjuvant therapy.
- SLNB:
  - using either a blue dye or a radiolabelled tracer
  - identifies patients with definite lymph node metastasis who can then proceed to formal regional nodal dissection. If the sentinel node is negative for a tumour deposit, then formal nodal dissection is not performed, avoiding the associated morbidity
  - a staging investigation, rather than a therapeutic intervention



- early studies have suggested that the sentinel node can be identified in up to 90% of cases, and the false negative rate may be as low as 2%. In 30–50% of patients, the sentinel node is the only positive node identified
- the risk of detecting malignant deposits in the sentinel node increases with the 1° tumour thickness (see Table 23.1). The results of several large-scale trials that should help clarify whether this approach compromises long-term survival are awaited
- in the UK, the use is limited to centres with established expertise, ideally within the context of a clinical trial, of which a number are ongoing.

**Table 23.1** Risk of identifying a metastatic deposit in a sentinel lymph node, according to the 1° tumour thickness

	Risk of metastatic deposit in sentinel node (%)
Breslow depth <0.75mm	1
≥0.75 Breslow depth <1.5mm	8
≥1.50 Breslow depth <4.0mm	23
Breslow depth ≥4.0mm	36

### Prognosis and risk of relapse

- Most patients present with stages I–IIA disease, when appropriate surgery is curative in the majority of cases, e.g. for stage IB, 90% cured by surgery, falling to 78% for those with stage IIA disease.
- Relapse rates, following resection, escalate rapidly with advancing stage:
  - stage IIB disease—risk of recurrence of 40% following local excision
  - stage III disease (which includes regional node involvement) — associated with relapse rates of >80%.
- The median survival with stage IV disease is typically <9mo, and with leptomeningeal involvement 5–16wk.

#### Post-operative surveillance

- In the UK, the current standard management, following resection of a 1° melanoma ± regional lymph node dissection, is a surveillance regime, often shared between:
  - the patient
  - their GP
  - a plastic surgeon and/or dermatologist
  - an oncologist.

**Adjuvant therapy**

- Adjuvant regimes aim to minimize the risk of relapse, particularly in patients at higher risk of recurrence (stages 2B–3).
- In the UK, there is no standard adjuvant treatment.

**High-dose interferon alfa-2b**

- High-dose IV interferon alfa-2b (HDI) is the most encouraging adjuvant regime.
- Typically involves 4wk of daily IV HDI (e.g. 20MIU/m<sup>2</sup>), followed by a lower dose s/c for a further 1–4y.
- Several large trials of HDI have produced conflicting results, with comparison between trials extremely problematic. Interpretation of pooled data has been complicated by the marked variation in the dosing and scheduling of interferon alfa-2b.
- There is a consensus that HDI affects the natural history of the disease in some way. All trials of HDI in intermediate- and high-risk patients have demonstrated that treatment with HDI is associated with modest improvements in relapse-free survival. Results from several cooperative group studies suggest that the risk of recurrence may be reduced by up to 38%.
- Any effect on the OS is more controversial. Individual trials have consistently failed to demonstrate any survival benefit with HDI. However, a recent meta-analysis of 14 RCTs, including >4000 patients, demonstrated that, in patients with particularly high-risk melanoma, the use of interferon alfa-2b is associated with an improvement in both DFS and OS.
- It is likely that there is a subset of patients at greatest risk of disease relapse (e.g. those with ulcerated primaries) who particularly benefit from HDI.
- Its mechanism of action is unknown, although suggestions include:
  - immune modulation
  - direct cytotoxic action (at high doses)
  - an anti-angiogenic role.
- Side effects include flu-like symptoms, myelosuppression, fatigue, hepatotoxicity, and depression ± mania.
- Lack of clarity over an optimal regime and which patients are most likely to benefit have prevented its acceptance as standard adjuvant therapy in the UK (not approved by NICE).

**Bevacizumab**

- mAb which binds to VEGF, inhibiting the growth of new blood vessels.
- Results of large multicentre randomized phase III adjuvant trial (AVAST-M) awaited (closed to recruitment in 2012). Interim analysis (median follow-up of 25mo) suggests no improvement in OS, but possibly a very small improvement in DFS.
- Risks include hypertension, bleeding, GI perforation, and delayed wound healing.

### Vaccines

- There is no randomized phase III trial to support the use of any vaccine as adjuvant treatment, following the resection of high-risk melanoma.
- Strategies have included attempts to enhance cellular immunity or induce humoral immunity.
- Tumour heterogeneity, tumour-reinforced tolerance, and poor immunogenicity of relevant antigens have all probably contributed to disappointing results.

### Loco-regionally advanced disease

- Includes:
  - recurrence at the site of the resected 1° disease
  - in-transit and satellite metastases
  - regional lymph node metastases.
- If there is no evidence of disseminated disease, further resection of solitary (or a very small number of) distant metastases can be considered. This approach can sometimes produce long-term survivors.
- Alternative approaches for the local control of unresectable disease include hyperthermic isolated limb perfusion ± melphalan infusion and occasionally radiotherapy.

## Management of metastatic disease

- No curative treatment for patients with stage IV disease.
- The aim of treatment is to palliate symptoms and maximize the QoL.
- The prognosis remains extremely poor. Despite recent advances, survival with disseminated disease generally continues to be measured in months.

### Molecularly targeted therapy

- The aim is to target specific genetic mutations within the tumour.
- The MAP kinase pathway is summarized in Fig. 23.5 and includes several targets for therapy. Treatment choice is dependent on the mutation status of the melanoma.
- All patients with advanced melanoma should have their tumour assayed for the presence of a mutation at the V600 site of the *BRAF* gene. Identifying mutations in other driver genes (e.g. *KIT*, *NRAS*) may facilitate entry into clinical trials.

#### *BRAF* inhibition

- 40–60% of advanced melanomas have an activating mutation in the *BRAF* gene (see Fig. 23.5)—usually V600E. Targeted inhibition of the mutant *BRAF* is associated with tumour response.
- Vemurafenib:
  - potent inhibitor of mutant *BRAF*
  - response rate of >50%
  - associated with longer PFS (6.9mo versus only 1.6mo on dacarbazine chemotherapy (see  Chemotherapy, p. 538) and improved OS
  - has activity in brain metastases
  - cutaneous side effects are problematic. Rashes, photosensitivity, and pruritus are common, and there is ~10% incidence of keratoacanthomas and SCCs. Other toxicities include QT<sub>c</sub> prolongation, arthralgia, and fatigue
  - tumour resistance inevitably develops, usually within 6mo
- Dabrafenib:
  - an alternative inhibitor of mutant *BRAF*, also shown to have significant activity in metastatic melanoma, including cerebral metastases.

#### *MEK* inhibition

- Combining the inhibition of mutant *BRAF* with *MEK* inhibition (see Fig. 23.5), e.g. dabrafenib with trametinib aims to:
  - increase the duration of the disease response (by suppressing pathways of acquired resistance)
  - reduce the incidence of 2° skin cancers caused by the inhibition of *BRAF* alone.
- There is evidence that this approach is effective, producing a longer PFS, higher objective response rate, and longer OS with significantly less skin toxicity.
- Currently remains only in the context of clinical trials in the UK but a NICE appraisal is due in 2015.

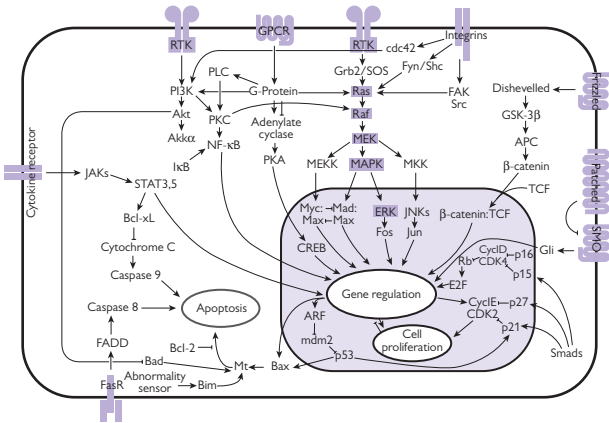

Fig. 23.5 The RAS/RAF/MEK/ERK signalling pathway: an important target in the treatment of metastatic melanoma (see Fig. 40.1).

### KIT inhibition

- Mutations in *c-kit* are present in up to 20% of patients with mucosal melanoma (see Mucosal melanoma, p. 541).
- There is optimism that tumours which express an activating *c-kit* mutation may respond to targeted inhibitors of KIT such as imatinib and sorafenib (see Small molecule inhibitors of tyrosine kinases, p. 183).

### Anti-angiogenesis

- Melanoma cells typically overexpress multiple blood vessel (angiogenesis)-promoting factors, e.g. fibroblast growth factor, VEGF. This overexpression appears to be associated with a poorer prognosis.
- Targeting these growth factors offers a further potential avenue for treatment.
- Bevacizumab:
  - mAb which binds to VEGF
  - stops VEGF from stimulating the growth of new blood vessels
  - encouraging phase II data in metastatic melanoma (used in combination with chemotherapy), suggesting a trend for improvement in PFS and OS, particularly in patients with the greatest metastatic burden
  - current use remains restricted to clinical trials.

### Immunotherapy

#### *Ipilimumab*

- mAb that targets the cytotoxic T-lymphocyte-associated antigen 4 (CTLA-4), a molecule on T-cells which suppresses the immune response.

- Acts as an immune stimulant (inhibiting immune inhibition), augmenting T-cell-mediated anti-tumour effects.
- Associated with a significant increase in median survival (3–4mo) when used first- or second-line.
- In patients who respond, the response may be durable, e.g. 2–5y survival rates of 20–30%.
- The response may take months to occur, and the disease may initially worsen—therefore, most appropriate in minimally symptomatic patients with low disease burden.
- Has activity against cerebral metastases.
- Side effects include colitis, rash, pituitary dysfunction (which may be permanent), and potentially life-threatening colitis.
- NICE-approved for the treatment of patients with advanced melanoma.

#### *Anti-PD-1/anti-PDL-1 antibodies*

- The programmed death-1 (PD-1) receptor is an immune checkpoint expressed by many cancer cells.
- Antibodies targeting PD-1 and its ligand (PD-L1), e.g. nivolumab, pembrolizumab, are the focus of many current melanoma trials.
- Data to suggest response rates in metastatic melanoma of 30–50%, including a proportion of patients with durable responses of >3y.
- The side effect profile appears favourable, compared to ipilimumab.
- Further clinical trials under way to assess whether combination with ipilimumab augments the response.
- The use remains restricted to the context of clinical trials.

#### *High-dose interleukin-2*

- Response rates of up to 20%, with occasional reports of long-term DFS, reported. Trials mainly non-randomized.
- Treatment limited by significant toxicities, including multiorgan toxicity, arrhythmias, hypotension, and capillary leak syndrome.
- In light of recent advances (e.g. ipilimumab), its role is likely to diminish further.

#### *Interferon alfa*

- Response rates of 10–20% reported. The median duration of response is only 4mo, although occasionally durable responses can be seen.
- Self-administered s/c, typically three times/wk.
- Treatment usually well tolerated.
- Most appropriate for those with small-volume, non-visceral disease.
- Combination with dacarbazine or temozolomide has demonstrated no increase in survival.
- Diminishing role, with the advent of evidence-based alternatives (e.g. bevacizumab, ipilimumab).

## **Chemotherapy**

### *Dacarbazine (DTIC)*

- Randomized data demonstrating an associated survival advantage are still lacking.

- Response rates of 7–20% documented in the literature, with a median duration of response of 4–6mo.
- Treatment is generally well tolerated.

#### *Temozolomide*

- Oral analogue of DTIC.
- Phase III data to support its equivalent activity (compared to DTIC) in metastatic melanoma.
- Potential advantage of greater CNS penetration (crosses the blood–brain barrier).
- Ongoing trials to establish the optimal regime and whether the use of other therapies, e.g. ipilimumab, novel enzyme inhibitors, may improve the efficacy.

#### *Combination regimes*

- Phase III data to support the equivalent activity of combination regimes (e.g. cisplatin, vinblastine, and DTIC) in metastatic melanoma remain lacking, and toxicity is significantly greater.
- In clinical trials, no combination regime has been shown to produce a survival benefit.

### **Surgery**

- Procedures to debulk the tumour and optimize the local control are occasionally appropriate.

### **Radiotherapy**

- Melanoma, in general, is not responsive to radiotherapy.
- Skeletal metastases—can achieve good palliation in the case of pain.
- Cerebral metastases—relatively common in long-term survivors from melanoma. If asymptomatic, there is controversy as to whether or not they should be treated. If symptomatic, corticosteroids should be commenced, and cranial irradiation can be considered.

## Intra-ocular melanoma

- A rare malignancy affecting the uveal tract, most frequently involving the choroid.
- Risk factors appear to include:
  - UV exposure
  - light iris colour
  - previous personal or family history of melanoma.
- Presentation is often an incidental finding at a routine visit to the optician in an asymptomatic individual. Alternatively, patients may present with visual loss.
- Investigation—biopsies should not be performed. Diagnosis should be made by an ophthalmologist with experience in this field.
- 80% of ocular melanoma contains a mutation in *GNAQ* or *GNA11*.
- Management is ideally carried out in a combined ophthalmic–oncology clinic at a designated centre. Options include:
  - observation
  - brachytherapy with radioactive eye plaques (e.g. ruthenium-106 or iodine-125)
  - charged particle irradiation
  - enucleation.
- ~80% of ocular melanomas carry a mutation in either *GNAQ* or *GNA11*, resulting in the activation of the MAP kinase pathway. This is the basis for several current clinical trials, e.g. that of the *MEK* inhibitor selumetinib.
- Prognosis is generally poor, with death from metastatic disease in >50% of affected patients. Dissemination is purely haematogenous, with hepatic involvement in 90% of those with metastatic disease.



## Mucosal melanoma

- Rare, primarily affects the head and neck, vulvovaginal, and anorectal regions.
- Aggressive surgical management offers the best chance of long-term survival.
- Differences to cutaneous melanoma:
  - typically affects older patients (median age of 70y)
  - ♀ > ♂
  - worse prognosis
  - more often multifocal and more frequently amelanotic
  - complete excision often problematic due to the location and pattern of growth
  - the majority develop metastatic disease
  - tumours have a lower incidence of activating mutations in *BRAF*, but one in four have a somatic mutation or an amplification of *KIT*
  - small numbers of patients mean little available controlled data on systemic therapy in metastatic disease. However, there are case reports of patients with *KIT* mutant melanoma responding to targeted inhibitors of *KIT*, e.g. imatinib, sorafenib (see Chapter 9).

## Non-melanoma skin cancer

### Primary non-melanoma skin cancers

#### Common

- BCC (see Fig. 23.6), i.e. keratinocyte skin cancers.
- SCC (see Fig. 23.7).

#### Uncommon

- There are several uncommon skin cancers, e.g.:
  - Merkel cell carcinoma
  - Kaposi's sarcoma (KS) (see Chapter 28)
  - cutaneous angiosarcoma—beyond the scope of this chapter.

### Secondary malignancies

- Malignant skin lesions may represent metastases, e.g.:
  - breast cancer
  - lung cancer
  - ENT malignancies
  - colon cancer
  - ovarian cancer
  - renal cancer.
- Usually, a late phenomenon. Rarely, a presenting feature.

### Epidemiology and aetiology

- BCCs are the commonest malignancy in Europe, Australia, and the US. The incidence continues to increase worldwide. SCCs are the second commonest skin cancer.
- Occur particularly in fair-skinned Caucasians.
- Almost 100 000 cases recorded in the UK per year (2010 figures, compiled in 2012, and likely a significant underestimate of the true incidence).
- The cause of very few deaths.
- Risk factors for development include:
  - UV radiation—sunlight remains the principal environmental cause of keratinocyte skin cancers. The use of tanning devices is also a risk factor
  - previous non-melanoma skin cancer
  - ionizing radiation
  - chronic inflammation
  - HPV
  - immunosuppression, e.g. post-organ transplant
  - hereditary conditions, e.g. 0.5% of BCCs occur in patients with the autosomal dominant basal cell naevus syndrome (Gorlin's).



Fig. 23.6 BCC (see also colour plate section).



Fig. 23.7 SCC (see also colour plate section).

**Presentation***Squamous cell carcinomas (SCC)*

- Represent ~20% of non-melanoma skin cancers.
- Arise on sun-exposed sites or at sites of chronic inflammation.
- Rapidly growing, red papule, or non-healing skin lesion.
- $\pm$  background of actinic keratosis.
- Ulceration and bleeding may occur.
- 5–10% metastasize, initially to regional lymph nodes.
- Risk factors for metastasis include:
  - recurrent disease
  - large size
  - tumour thickness
  - deep invasion
  - rapid rate of growth
  - disease associated with chronic scars, sinus tracts, and certain anatomical sites, e.g. the lip
  - host immunosuppression.
- Loco-regionally, metastatic disease is associated with a 5y survival of  $\leq 65\%$ . Disseminated disease has a very poor prognosis.

*Basal cell carcinomas (BCC)*

- Represent ~75% of non-melanoma skin cancers.
- Lesions arising on sun-exposed areas, e.g. the face, ears, scalp.
- Normally confined to hair-bearing skin.
- Slow-growing, pink or pearly (translucent) papule, often with telangiectasia.
- Typically indolent, although can be locally invasive, causing significant disfigurement.
- Metastases are rare (0.1%), although 50% of tumours  $>5\text{cm}$  are associated with metastases.

**Management***Basal cell carcinomas*

- Usually curable ( $\geq 90\%$  for 1<sup>o</sup> disease). Certain factors predict a higher risk of local recurrence, including:
  - a sclerosing, micronodular, or mixed growth pattern
  - perineural invasion
  - baso-squamous differentiation.
- Despite their low metastatic potential, early definitive treatment is important, as local invasion can be associated with significant morbidity.
- Several effective techniques exist for the effective management of BCC. Careful assessment of both the patient and tumour is required to select the most appropriate intervention.
- Surgical excision:
  - allows the assessment of histological features and the adequacy of resection margin.
  - NICE guidelines (updated 2010) specify that low-risk BCCs may be managed in 1<sup>o</sup> care, provided the GP or other health care professional has been accredited to do so. If the patient or tumour does not fulfil certain criteria (e.g.  $>25\text{y}$  old, immunocompetent,

tumour <1cm, location below the clavicle), then referral to the local skin MDT is mandatory.

- Mohs' micrographic surgery:
  - specialized surgical technique
  - micrographic surgery, in which the tumour is excised at an oblique angle in a series of stages and examined microscopically
  - the oblique angle of surgery maximizes the examination of the peripheral margin
  - further excision continues, until all margins are negative
  - guidelines drawn up by British Association of Dermatologists (last updated 2008) advocate this technique, in particular if:
    - the tumour is >2cm
    - the tumour margins are difficult to define deep invasion
    - the tumour is recurrent
    - the tumour is located centrally on the face, or
    - the tumour is near the eyes, lips, nose, or ears
    - perineural or perivascular involvement is suspected
  - in the UK, the requirement for specialist training and equipment means there is currently limited availability of this technique.
- Cryotherapy or electrosurgery:
  - used for the treatment of low- and intermediate-risk lesions
  - 5y recurrence rate for 1° BCCs of ~8–13%.
- Radiotherapy:
  - appropriate for both 1° and recurrent disease, particularly in elderly patients
  - usually avoided in patients aged <50y, due to long-term risk of 2° cutaneous malignancies within the radiation field
  - 5y cure rates of >90% for previously untreated lesions
  - especially useful around the eyelids, nose, and lips, when the cosmetic result is likely to be superior to surgical techniques
  - contraindicated in patients with hereditary basal cell naevus syndrome.
- Photodynamic therapy:
  - uses light and a topical photosensitizing agent to produce tumour destruction, with response rates of 82–100% reported
  - advantages—good cosmetic results, well tolerated
  - disadvantages—lengthy treatment, long-term recurrence rates unknown.
- Chemotherapy:
  - may achieve cure rates of >90% in selected patients with low-risk BCCs, e.g. with topical fluorouracil.
- Ongoing surveillance:
  - 80% of recurrences will occur within the first 5y
  - ~40% of patients will develop a new 1° BCC within the same period
  - a previous diagnosis of a 1° skin cancer is a risk factor for further cutaneous malignancy.

**Squamous cell carcinomas**

- RCTs comparing treatment modalities in SCC are lacking.
- Surgical excision:
  - the commonest treatment for cutaneous SCC
  - allows the histological assessment of the adequacy of the margin of excision
  - resection of the 1° ± loco-regional lymph node dissection of any clinically evident lymph node metastases (spread to local lymph nodes is the commonest route for the development of metastases)
  - a 5y cure rate of >90% is reported for the excision of localized 1° disease
  - a potential role for SLNB awaits further study
  - Mohs' micrographic surgery can be considered for tumours at difficult sites (see previous section).
- Cryotherapy (e.g. using pressurized liquid nitrogen) or electrosurgery:
  - can be used for *in situ* disease or small, low-risk lesions
  - the disadvantage of these techniques is they prevent the confirmation of clear margins.
- Radiotherapy:
  - most useful for small, well-localized lesions
  - the reported 5y cure rate is ~90%
  - can also be used as adjuvant treatment, following incomplete surgical excision or in patients with nodal involvement.
- Chemotherapy:
  - has been used for disseminated disease, e.g. with cisplatin.
- Cetuximab:
  - mAb against EGFR
  - SCC has been shown to overexpress EGFR
  - phase II trial data and case reports suggest cetuximab, combined with radiotherapy, may be superior to radiotherapy alone
  - potential future therapeutic option for recurrent or advanced SCC; randomized trials needed
  - see also Chapter 9 and Chapter 21.
- Ongoing surveillance:
  - 95% of relapses will occur within 5y
  - ~50% of patients will also develop a new non-melanoma skin cancer, also within 5y.

**Prevention and future directions**

- Any patient with a non-melanoma skin cancer should be advised about the importance of sun avoidance to minimize future risk.
- New research on non-invasive treatments for BCCs and SCCs is ongoing and includes trials of cyclo-oxygenase-2 (COX-2) inhibitors and biological response-modifying agents. Results are awaited.

## Merkel cell carcinoma

- Rare malignant skin tumours, most commonly arising in the head and neck area or on the limbs.
- Propensity for local recurrence and regional and distant spread.
- Pathologically, these tumours have neuroendocrine features.
- Clinical presentation is typically with a red or purple nodule, with a shiny overlying epithelium.
- Staging requires, at a minimum, a CXR and an assessment of regional lymph nodes, commonly by CT or MRI scan.
- SLNB may have a role in this tumour.
- At presentation:
  - 40% localized
  - 50% regional spread
  - <10% metastatic disease.
- The optimum management of these tumours remains controversial.
- Although they are sensitive to both radiotherapy and chemotherapy, the role of the adjuvant treatment of localized disease is uncertain.
- Patients with operable disease are best managed by surgery, but adjuvant radiotherapy and chemotherapy (e.g. platinum and etoposide) may be considered for patients with regional spread.
- Treatment outcome is dependent on the stage at presentation:
  - localized node-negative disease—>90% 5y survival
  - positive lymph nodes—50–60% 5y survival
  - metastatic disease—9mo median survival.

## Further reading

- Ascierto PA, Gogas HJ, Grob JJ, et al. (2013). Adjuvant interferon alfa in malignant melanoma: an interdisciplinary and multinational expert review. *Crit Rev Oncol Hematol* **85**, 149–61.
- Evans MS, Madhunapantula SV, Robertson GP, Drabick JJ (2013). Current and future trials of targeted therapies in cutaneous melanoma. *Adv Exp Med Biol* **779**, 223–55.
- Maio M, Di Giacomo AM, Robert C, Eggermont AM (2013). Update on the role of ipilimumab in melanoma and first data on new combination therapies. *Curr Opin Oncol* **25**, 166–72.
- Mihajlovic M, Vljakovic S, Jovanovic P, Stefanovic V (2012). Primary mucosal melanoma; a comprehensive review. *Int J Clin Exp Pathol* **5**, 739–53.
- Motley RJ, Preston PW, Lawrence CM; British Association of Dermatologists (2009). *Multiprofessional guidelines for the management of the patient with primary cutaneous squamous cell carcinoma*. Available at: [http://www.bad.org.uk/library-media/documents/SCC\\_2009.pdf](http://www.bad.org.uk/library-media/documents/SCC_2009.pdf).
- Soong SJ, Ding S, Coit DG, Balch CM, Gershenwald J, Thompson JF; American Joint Committee on Cancer, Melanoma Task Force. *Individualized melanoma patient outcome prediction tools*. Available at: <http://www.melanomaprognosis.org>.
- Telfer NR, Colver GB, Morton CA; British Association of Dermatologists (2008). Guidelines for the management of basal cell carcinoma. *Br J Dermatol* **159**, 35–48.



# Haematological malignancies

- Acute leukaemia 550
- Chronic myeloid leukaemia 558
- Myelodysplastic syndromes 562
- Chronic lymphoid leukaemias 566
- Hodgkin's lymphoma 574
- Non-Hodgkin's lymphomas 582
- Myeloma 594
- Further reading 601

## Acute leukaemia

### Epidemiology

The incidence of acute leukaemia is 4–7 cases per 100 000. The peak incidence of ALL is 2–4y, and that of AML is over 60y.

### Aetiology

The cause of most cases is unknown. Some congenital and inherited diseases carry an increased risk:

- Down's syndrome
- Fanconi's anaemia
- Bloom syndrome
- Klinefelter's syndrome
- neurofibromatosis
- ataxia–telangiectasia.

There is a 3–5 times increased risk in identical twins.

Environmental factors implicated in leukaemogenesis include ionizing radiation, including *in utero* exposure for childhood ALL, chemical carcinogens, especially benzene and including cigarette smoking (2-fold increase), chemotherapeutic drugs, and infectious agents (e.g. T-cell leukaemia virus 1 in the Caribbean or Japan, causing adult T-cell leukaemia/lymphoma). It seems that, in at least some cases of childhood ALL, a genetic predisposition is acquired *in utero* in markers of the leukaemic clone, e.g. a single copy of the t(12;21) translocation producing the *TEL-AML1* fusion gene or a clonal *IgH* gene rearrangement are identifiable on testing Guthrie card blood spots or umbilical blood samples. Subsequent additional genetic mutations, e.g. deletion of the second *TEL* gene occurring after birth, perhaps following exposure of naive immune systems to infections, then lead to childhood ALL.

### Pathology

Acute leukaemias arise from the malignant transformation of haemopoietic stem/early progenitor cells, so-called 'leukaemia stem cells'. The leukaemic progeny proliferate but fail to differentiate properly, leading to the accumulation of poorly differentiated leukaemic blast cells in the marrow and bone marrow failure.

### Clinical presentation

Acute leukaemia presents with features of bone marrow failure:

- anaemia
- thrombocytopenic bleeding
- infections, mainly bacterial or fungal.

There may also be features of extramedullary leukaemic infiltration, more commonly in ALL or monocytic forms of AML:

- hepatosplenomegaly
- lymphadenopathy
- leukaemic meningitis
- testicular infiltration
- skin nodules.

**Table 24.1** WHO classification of acute leukaemias**WHO classification of ALL**

B-lymphoblastic leukaemia/lymphoma, not otherwise specified  
 B-lymphoblastic leukaemia/lymphoma with recurrent genetic abnormalities  
 T-lymphoblastic leukaemia/lymphoma

**WHO classification of AML**

AML with recurrent genetic abnormalities  
 AML with myelodysplasia-related changes  
 Therapy-related AML  
 AML not otherwise specified  
 Myeloid sarcoma  
 Myeloid proliferations related to Down's syndrome  
 Acute leukaemia of ambiguous lineage

Reproduced with kind permission of the World Health Organization (WHO). <http://www.who.int>.

Patients with acute promyelocytic leukaemia (APL) can present with excessive bleeding as a result of 1° fibrinolysis and disseminated intravascular coagulation (DIC).

**Diagnosis and classification**

Peripheral blood pancytopenia is the commonest finding, but some cases have an elevated WCC.

A marrow examination, using morphology, immunophenotyping, cytogenetics, and increasingly molecular genetics, is the basis of diagnosis. This will allow the classification into myeloid or lymphoid leukaemia and give important prognostic information. Acute leukaemia is diagnosed when the bone marrow blast count is >20% of nucleated cells. The present WHO classification of acute leukaemia is shown in Table 24.1. CNS infiltration can be a feature of ALL and requires a diagnostic lumbar puncture.

**Acute lymphoblastic leukaemia**

ALL is the commonest cancer in children (23% of cancer diagnoses in children under 15y), with modern treatment producing a leukaemia-free survival at 5y of ~80%. Most of these will be cured. Adult disease responds less well, with only 30–50% of long-term survivors. This relates to an excess of poor prognostic features in adults, with some 30% having one or more of these:

- high WCC
- older age
- poor genetics such as t(9;22), t(4;11), or t(1;19)
- delayed disease clearance (>4wk) with induction chemotherapy.

**Management**

It is important that children and adults with ALL are treated in expert centres. Increasingly, it is recognized that adolescents benefit from treatment in an environment that deals with patients of the same age and provides the type of support needed by teenagers. Recently, it has been accepted that

patients up to the age of early 20s have better outcomes when treated on childhood protocols.

Children with ALL are now treated according to risk groups, and increasingly this approach is being trialled in adults. Traditional clinical and laboratory features of prognostic significance in children include the following:

- age at diagnosis—infants aged <1y poor prognosis; children aged 1–9y do better than children aged 10–18y
- WCC at diagnosis— $<50 \times 10^9/L$  better prognosis than higher WCC
- the presence or absence of CNS disease at presentation
- gender—girls have a slightly better prognosis than boys
- hypodiploidy (<45 chromosomes) of ALL cells on karyotyping carries a poorer prognosis than normal numbers or hyperdiploidy
- specific acquired genetic abnormalities, including the Philadelphia chromosome t(9; 22) and rearrangement of the *MLL* (mixed lineage leukaemia) gene on chromosome 11q23, carry a worse prognosis. *MLL* rearrangements are common in infantile ALL
- response to treatment—children who clear their bone marrow of blasts within 7–14 days of induction have a better prognosis than those who do not. Early clearance of blasts in the blood with steroids is also favourable
- it is now recognized that the level of minimal residual disease (MRD) by molecular or flow cytometric technology post-induction is the most sensitive and specific prognostic risk factor in children and young adults, with negative MRD being favourable and independent of traditional risk factors
- the recent first publication from the UKALL 2003 trial has confirmed the good prognosis of negative MRD. It has shown that, in such patients, subsequent treatment intensity can be reduced from two intensification blocks of chemotherapy to one.

### Chemotherapy

Patients with B-ALL (Burkitt's leukaemia) are generally treated as Burkitt's lymphoma (BL) with short intensive courses of chemotherapy (see  Burkitt's lymphoma, p. 589).

Philadelphia-positive cases are treated on experimental protocols, based around stem cell transplantation and imatinib or similar TKIs. All others are treated on ALL protocols, adapted to the risk group of the patient. Treatment is in three stages: induction of remission, intensification (consolidation), and maintenance.

### Induction of remission

This is routinely achieved by combining vincristine, steroids (dexamethasone is better than prednisolone), and L-asparaginase (pegylated is preferred to non-pegylated). Additional anthracycline is used in adults and poor-risk children. Remission rates are 90–95% in children and a little less in adults.

### Intensification

This is a crucial phase during which exposure to new drugs (e.g. cyclophosphamide, cytarabine) is a key strategy, as is clearance of the CNS as a sanctuary site. This may be achieved by CNS irradiation or MTX intrathecally or by intermediate- or high-dose IV.

Intensification can be safely reduced from two blocks to one in children and young adults with negative MRD after the induction phase.

In high-risk cases, there remains a 10% risk of CNS relapse, and there are concerns about the long-term effects of different treatment modalities.

#### *Maintenance*

For about 2y, patients in remission continue on a cyclical schedule of MTX, mercaptopurine, vincristine, steroids, and intrathecal prophylaxis, if cranial irradiation has not been given.

#### *Management of high-risk disease*

Various approaches are in use for high-risk disease. Intensification in consolidation with cyclophosphamide or MTX in higher dosage has brought some success, and allogeneic stem cell transplantation has been vigorously pursued for its graft versus leukaemia (GVL) effect in reducing relapse risk. Data in adults from the MRC UKALL XII, HOVON study group, and others have helped clarify the role of transplantation. Using a biological randomization and intention-to-treat analysis, based on whether a patient has a sibling donor or not, there is clearly a 5y DFS advantage (~60% versus ~40%) for having a donor, the majority of whom receive an allogeneic stem cell transplant in first remission. For those without a donor, UKALL XII demonstrated that standard maintenance therapy was better than receiving an autologous transplant.

When treatment fails, the outcome depends on the age and length of first remission. In children with long remissions, further chemotherapy may achieve salvage; for others, allogeneic stem cell transplantation is indicated, including from matched unrelated donors.

Philadelphia chromosome-positive ALL carries a very poor prognosis when treated with chemotherapy alone. Recent results, with the addition of the *BCR-ABL* inhibitor imatinib and planned allogeneic stem cell transplantation from a matched donor of any source, have been encouraging, with remission rates of >90% and 3y DFS approaching 50%.

### **Acute myeloid leukaemia**

At diagnosis with AML, the patient's age, performance status, and whether or not the subtype is APL determine the initial clinical approach.

- APL must be identified at diagnosis to ensure that all-*trans* retinoic acid (ATRA) is included promptly in the treatment schedule.
- It is now usual that patients under 60y who are relatively fit are offered intensive treatment with curative intent that may include allogeneic stem cell transplantation.
- Older patients constitute the majority and often are not considered suitable for intensive treatment. The outcome for this age group has not improved during the last 20y, and therapy is centred on palliation with blood product-based supportive care and trials of novel therapeutic agents.
- A major contributor to better survival over the last 30y has been improved supportive care. This includes appropriate use of blood product support, including platelets, and the successful management of neutropenic sepsis with antibiotics and an increasing range of effective antifungal drugs.

### Chemotherapy

Anthracycline and cytarabine, given over 7–10 days, have been the backbone of treatment for 30y. The addition of a third drug (thioguanine or etoposide) is widely used, but there is little evidence that one or the other is superior. Recent data from UK and French trial groups have shown that the addition of targeted chemotherapy, in the form of anti-CD33-bound calicheomycin (gemtuzumab ozogamicin, GO), to daunorubicin and cytarabine leads to better survival for good- and possibly standard-risk patients, but not poorer-risk patients. The dose of anthracycline in induction may also influence survival.

Successful induction is defined as achieving first remission (normal blood counts and bone marrow blasts <5%) and depends on patient age (90% in children, 75% in 50–60y, 65% in 60–70y); 70–80% of all patients achieve complete remission (CR) with the first course. Between two and four further intensive courses incorporating other drugs (e.g. amsacrine, etoposide, idarubicin, mitoxantrone, and cytarabine at higher doses) are usually given. It is not, at present, clear how many courses of consolidation are optimal. Older patients seldom tolerate >2, and there seems little benefit for >4 courses of intensive chemotherapy in total in younger patients.

### Non-intensive treatments

The standard therapy for older and frailer patients has been low-dose s/c cytarabine. This produces a remission rate of ~20% and is superior to oral hydroxycarbamide. For patients with low blast count AML (21–30%), the hypomethylating agent azacytidine has been shown to produce longer survival than other conventional approaches, including low-dose ara-C.

Present approaches for the majority of elderly/frail patients not suitable for intensive chemotherapy include supportive care and randomizing novel agents, such as FLT3 inhibitors, against low-dose cytarabine. The 'pick a winner' approach identifies such agents with promising clinical efficacy in phase II studies and carries them promptly on to phase III, whilst discarding ineffective therapies. To date, with the exception of azacytidine for low blast count AML, no novel agent has been shown to be preferable to low-dose cytarabine.

A number of characteristics can identify different risks of relapse, and therefore survival. Most powerful of these are cytogenetics (favourable, intermediate, poor), patient age (young better than elderly), and the initial response of marrow blasts to treatment (remission with the first course or not). Other factors associated with a poor prognosis include:

- high WCC on presentation
- molecular markers such as *FLT3* internal tandem duplication (*FLT3 ITD*)—present in 30% of cases and predictive of relapse
- less cellular differentiation—undifferentiated leukaemia
- leukaemia 2° to prior chemotherapy (t-AML)
- leukaemia 2° to myelodysplasia (s-AML)
- the length of first remission—<6–12mo very poor.

Favourable cytogenetics are t(8:21), t(15:17), and inv(16), which comprise about 25% of patients aged <60y. Examples of poor-risk cytogenetics include abnormalities of chromosomes 5 or 7, del(3q), monosomal karyotypes (>1 monosomy or one monosomy and a structural abnormality), or

complex (multiple) abnormalities that tend to be more frequent in older patients and are associated with t-AML and s-AML. Intermediate-risk cytogenetics include a normal karyotype and abnormalities not defined by the other risk groups. The identification of molecular abnormalities within the normal cytogenetic group is helping improve predictions of treatment outcomes in this difficult group, e.g. *FLT3* ITD+ poor risk, nucleophosmin (*NPM1*) mutation+ without *FLT3* ITD good risk, *CEPBA* mutation+ good risk. Recent data suggest that MRD, as measured by the presence of a residual leukaemic specific phenotype after remission induction, may be a powerful prognostic feature, as in ALL.

#### *Stem cell transplantation*

Allogeneic stem cell transplantation reduces the relapse risk in AML through the GVL effect. This benefit is offset by the toxicity of the transplant procedure, and hence an OS advantage has been difficult to demonstrate. However, recent analyses of the large MRC dataset, using a more sophisticated measure of risk than just cytogenetics and response, clearly show a survival benefit (33% versus 18%) for those defined as poor risk, even though only 30% of eligible patients received a transplant. No clear benefit has been shown in donor versus no donor analyses in standard-/intermediate-risk patients, however defined, although younger patients actually receiving a transplant probably do have a survival advantage, and many centres adopt this strategy for younger standard-risk patients with a suitable donor. There is no benefit for good-risk patients transplanted in first remission. Overall, if the patient is relatively young (<60y) and has a human leucocyte-associated antigen (HLA)-matched donor, allogeneic transplantation of blood or bone marrow stem cells will be considered in poor- and standard-risk patients in first remission and in all patients beyond first remission. The development of less toxic reduced intensity conditioning (RIC) regimens, based on immunosuppression without myeloablation, improve the risk–benefit analysis and allow transplantation of older, frailer patients. Maturing results with RIC allografts in AML appear to be as good as those achieved with myeloablative regimens in younger patients. Data from AML 15 demonstrate a clear 5y survival benefit in the 40–60y age group for matched sibling RIC allografts (61%) over no transplant (41%) or transplant with a matched unrelated donor (35%). At present, therefore, patients aged <40y will generally be offered a conventional myeloablative allograft, whilst older patients will be offered RIC allograft, especially if they have a suitable sibling donor.

#### *Acute promyelocytic leukaemia*

This is a separate entity having a FAB-M3 morphology (malignant promyelocytes) and the t(15:17) rearrangement, creating the *PML-RARA* fusion gene. ATRA used alone can induce remission by differentiation without hypoplasia but is not curative. Additional chemotherapy (APL is very sensitive to anthracyclines) or increasingly arsenic trioxide (ATO), given along with ATRA, remains essential to eliminate the leukaemic clone. ATRA reduces the risk of early death through haemorrhage. However, there is still a significant early haemorrhagic death rate of between 5% and 20%, before patients receive effective therapy, and this remains an important area to be addressed.

The WCC at diagnosis is of key importance. Low count patients ( $<10 \times 10^9/L$ ) given ATRA and anthracycline will have  $>90\%$  survival. The 25% of patients who present with higher WCC have a high risk of early death or relapse, and only 60% survival. Italian and Spanish groups have developed less toxic regimens, based on ATRA and idarubicin induction and consolidation, followed with ATRA-based maintenance chemotherapy. In the NCRN AML 15 randomized comparison of this lower intensity approach with four cycles of traditional intensive AML therapy and ATRA, the remission and survival rates are as good with less toxicity and better compliance. However, the role of maintenance has not been proven. Patients with a higher WCC may benefit from the addition of cytarabine.

The *PML-RARA* fusion transcript is detectable by sensitive RT-PCR and allows the monitoring of molecular MRD. It is now clear that achieving molecular negativity is associated with prolonged survival, whereas persistent or relapsed positivity in the bone marrow invariably predicts for a haematological relapse. Therefore, patients in remission are monitored for molecular relapse and offered treatment, before full haematological relapse, with the differentiating agent ATO, followed, where appropriate, by transplantation. Indeed, very recent randomized data from the GIMEMA group suggest that low-risk patients can be treated at presentation with a non-chemotherapy regimen of ATRA and ATO, with careful molecular monitoring, and have excellent outcomes which are at least non-inferior to treatment with standard chemotherapy and produces a 2y survival of  $>95\%$ . Similarly, the Australian APML 4 trial has suggested ATRA plus ATO with limited idarubicin in induction only, followed by maintenance, produces outstanding 2y survival of  $>90\%$ . Therefore, for low-risk APL, minimal chemotherapy or chemotherapy-free regimens are likely to become standard of care.

#### *Treatment outcome in acute myeloid leukaemia*

Remission is achieved in 80% of patients under 60y, and 60–65% of patients over 60y. Survival is age-related and will depend on the prognostic factors outlined earlier. At present, some 50% of patients under 60y will be long-term survivors, whilst only 10–15% of older patients survive beyond 3y. Therefore, most patients will relapse. If first remission is short ( $<6$ –12mo) and cytogenetics are not favourable, the outlook is grave.

#### *Future prospects*

AML is a heterogeneous disease, and the increasing characterization of biological and clinical features associated with disease outcome will allow better risk-directed therapy. There will be ongoing refinements in the techniques of stem cell transplantation, allowing the harnessing of GVL, independently of graft-versus-host disease. The disease in the elderly remains a major challenge. Standard chemotherapy approaches have not improved the outcome in this age group, and the 5y survival is of the order of 10%. It must be established which elderly patients, if any, benefit from an intensive approach. Improved more targeted, non-intensive treatment is needed for the majority, and, to this end, the 'pick a winner' approach discussed may allow the timely identification of efficacious novel agents.





## Chronic myeloid leukaemia

### Epidemiology

CML can occur in either sex and in any age group. The disease most commonly presents between the ages of 40 and 60y. There is an association with exposure to ionizing radiation, e.g. atomic bomb survivors.

### Pathology

CML is a malignancy arising from a mutated haemopoietic pluripotential stem cell. In CML, a clone of cells replaces the normal bone marrow, with enhanced proliferative capacity, but, unlike in acute leukaemia, the cells retain their ability to differentiate during the chronic phase of the disease. In 97.5% of cases, there is a reciprocal translocation between chromosomes 9 and 22, which, in most cases, can be recognized in standard karyotypes as a Philadelphia chromosome (small chromosome 22). This t(9;22) results in a new fusion gene called *BCR-ABL1*. The protein product of this gene behaves as an abnormal TK and is the cause of the leukaemia. Knowledge of its pathogenesis has been utilized to develop highly effective targeted therapeutic agents for CML.

The disease runs a chronic phase for a number of years. Eventually, the leukaemia loses its ability to differentiate normally and enters 'blast crisis', resembling an acute leukaemia of myeloid or, less frequently, of lymphoid origin, which is fatal. Modern therapy has been hugely successful in preventing or delaying this transformation and prolonging survival.

### Clinical features

In the chronic phase, the presenting symptoms are anaemia, weight loss, and splenomegaly. Patients can develop gout.

Rarely, altered consciousness, blurred vision, and cardiorespiratory failure can occur from hyperviscosity with a very high WCC.

### Investigations

- FBC.
- Blood film.
- Bone marrow.
- Cytogenetics.
- Molecular genetics.

Leucocytosis is a uniform feature, and the WCC can be in excess of  $300 \times 10^9/L$ . A normochromic anaemia is usually present, whilst platelets are commonly increased (sometimes over  $1000 \times 10^9/L$ ). The blood film resembles a bone marrow aspirate, with all stages of myeloid differentiation present. The bone marrow is hypercellular, with predominant granulocytopoiesis. In blast crisis, increased numbers of blast cells become evident in blood and bone marrow. Correspondingly, anaemia and thrombocytopenia are more marked. ~95% of patients have the Philadelphia chromosome on routine G-banding, and a further 2.5% will have an occult t(9;22) translocation, identified by a positive PCR for the *BCR-ABL1* transcript. ~2.5% are negative for the t(9;22) translocation (by G-banding and PCR) and are termed atypical CML, *BCR-ABL1*-negative.

## Management

### Chronic phase

Initial treatment may involve leukapheresis, if the WCC is very high and there are signs and symptoms of hyperviscosity. If there is no ready access to TKIs, hydroxycarbamide is used to reduce the WCC. Patients with high WCC and hyperviscosity should not be transfused red cells, until this is corrected.

### Tyrosine kinase inhibitors

One of the licensed TKIs, imatinib or the second-line agents nilotinib and dasatinib are now considered standard initial therapy in all adult patients. These drugs variably bind to the adenosine triphosphate (ATP)-binding site of *BCR-ABL1* and inhibit the function of the TK protein. Complete haematological responses are achieved in 95% of patients. At a median follow-up of 7y, the IRIS randomized study of imatinib versus IFN- $\alpha$  with cytarabine demonstrated complete cytogenetic responses of 69% by 12mo, and 87% by 60mo, for imatinib. The OS of patients who received imatinib as initial therapy was 86%. However, 30% of patients were no longer taking imatinib for a variety of reasons, including resistance, intolerance, and withdrawal of consent. Complete cytogenetic response and a maximum molecular response (3-log reduction in *BCR-ABL1* transcripts) were associated with a 100% freedom from progression at 60mo, although most patients still have detectable *BCR-ABL1* transcripts. Interestingly, the rate of progression on imatinib falls off year by year beyond 3y.

Recently, two randomized trials have shown that the more potent second-generation TKIs nilotinib and dasatinib, when compared with imatinib, lead to faster responses, a higher proportion of complete cytogenetic and molecular responses, and lower rates of transformation to blast crisis. As such, these agents are likely to steadily replace imatinib as first-line therapy. TK inhibition of *BCR-ABL1* is a landmark targeted therapy that has revolutionized the outlook for this disease, with median survival times now beyond 10y. Some patients become *BCR-ABL1*-negative, and the limited data have suggested that about half of these will not progress if they stop TKI therapy. The term 'operational cure' has been suggested for long-term non-progressors on imatinib with residual small detectable quantities of *BCR-ABL1*. Only time will tell if this is the case.

However, as discussed, one-third of patients stop taking imatinib over the longer term. The European LeukemiaNet has defined criteria for imatinib failure or suboptimal response at various time points on therapy. Prospectively, these criteria predict for poor outcome. The options for such patients are higher doses of imatinib, switching to the second-generation TKI alternatives nilotinib, dasatinib, and bosutinib, or allogeneic stem cell transplantation.

One particular *BCR-ABL1* mutant *T315I*, which prevents drug docking, has proved resistant to all currently licensed TKIs, including newer agents such as bosutinib. However, very recently, the TKI ponatinib was shown to produce complete haematological responses in 12 patients with this mutation, including nine complete cytogenetic responses. If confirmed, this will be a major development in tackling resistant disease.

*Allogeneic stem cell transplantation*

Allogeneic stem cell/bone marrow transplantation offers the potential of cure for CML. The precise role of allogeneic transplantation, following the introduction of TKI therapy, has been controversial. However, it is predominantly now seen as a second-line therapy for appropriate patients defined as failing TKI therapy. It might be considered in children or adolescents as first line, if an appropriate donor is available. The best results are achieved in young (<30y), fit patients with a suitable fully matched donor. The transplant-related mortality (TRM) ranges from 15% to 40%. The relapse rates are usually <20%. Cured patients have no detectable *BCR-ABL1* by PCR, which is the benchmark for alternative therapies.

*Second-generation tyrosine kinase inhibitors—nilotinib and dasatinib*

Nilotinib is a more potent inhibitor of *BCR-ABL1*, and dasatinib is more potent and inhibits a wider spectrum of kinases, including *src*. Both are now used for patients who are defined as imatinib failures and, as stated, increasingly as first line. Responses in imatinib-resistant patients are at least as good as using higher doses of imatinib (600mg or 800mg), except for the kinase domain mutation *T315I* that is resistant to both second-line TKIs and high-dose imatinib but may respond to ponatinib (see ↻ Tyrosine kinase inhibitors, p. 559). Dasatinib produces complete cytogenetic responses in 40% of imatinib-resistant patients and 70% of imatinib-intolerant patients, with a PFS of 90% at a median follow-up of 15mo.

*Accelerated phase and blast phase*

Patients who progress from chronic phase still fare poorly. Imatinib, often used at the higher doses, and second-generation TKIs produce responses in advanced disease, but the benefits are relatively short-lived. Combination chemotherapy may return the patient to the chronic phase, especially from lymphoid blast crisis. Allogeneic or autologous transplantation may prolong the second chronic phase.



## Myelodysplastic syndromes

Myelodysplastic syndromes (MDS) are a group of neoplastic disorders of the bone marrow, characterized by dysplastic haemopoiesis and peripheral blood cytopenias. As part of the family of myeloid neoplasms, there is a tendency for the disease to progress to AML.

### Epidemiology

The incidence of MDS is about 4 per 100 000 per year, with a peak incidence of >30 per 100 000 in the over 80s. The median age is in excess of 70y. Risk factors for developing MDS include exposure to previous chemotherapy, especially alkylating agents, radiation, and benzene.

### Pathology

The hallmarks of these diseases are hypercellular bone marrow with dysplastic cell morphology and paradoxical peripheral blood cytopenias. The paradox may result from the apoptosis of dysplastic bone marrow progenitor cells, in turn leading to an ineffective production of differentiated cells for release into the blood, especially in early stages of the disease. The disease subtypes are classified according to the WHO criteria, based on the number of lineages involved, presence of ring sideroblasts, blast count, and presence of specific cytogenetic abnormalities (see Table 24.2 and Table 24.3).

### Clinical features

Symptomatic anaemia is the most common presentation, but patients may also present with bleeding from thrombocytopenia or with recurrent infections, owing to neutropenia. Patients with chronic myelomonocytic leukaemia (CMML) may have hepatosplenomegaly or other evidence of tissue infiltration by leukaemic cells. Patients die from the effects of bone marrow failure or progression to AML, which occurs in about one-third of cases.

### Investigations

- FBC.
- Blood film.
- Bone marrow.
- Cytogenetics.

Macrocytic anaemia is usual, and neutropenia, thrombocytopenia, and monocytosis may also be evident. The peripheral blood film shows evidence of dysplasia, including misshapen red cells, agranular neutrophils, and circulating blast cells.

The bone marrow is usually hypercellular, with dysplasia in at least 10% of the cells in one or more cell lines. Typical dysplastic features in the marrow are megaloblastoid change, binucleated erythroblasts, megakaryocytes with multiple separate nuclei, micro-megakaryocytes, and increased blast cells of 5–20%. Ring sideroblasts may be present and are >15% of erythroblasts in sideroblastic subtypes. Bone marrow cytogenetics often demonstrate a clonal cytogenetic abnormality of prognostic importance.

**Table 24.2** WHO classification of MDS

Refractory cytopenia with unilineage dysplasia
Refractory anaemia with ring sideroblasts (RARS)
Refractory cytopenia with multilineage dysplasia with or without ring sideroblasts (RCMD)
Refractory anaemia with excess blasts-1 (RAEB-1; 5–9% blasts)
Refractory anaemia with excess blasts-2 (RAEB-2; 10–19% blasts)
Myelodysplastic syndrome unclassified (MDS-U)
MDS associated with isolated del(5q)

Reproduced with kind permission of the World Health Organization (WHO). <http://www.who.int>.

**Table 24.3** WHO classification of myelodysplastic/myeloproliferative syndromes

Chronic myelomonocytic leukaemia (CMML)
Myelodysplastic/myeloproliferative neoplasm: unclassifiable
Juvenile myelomonocytic leukaemia (JMML)

Reproduced with kind permission of the World Health Organization (WHO). <http://www.who.int>.

## Management

### *Blood and platelet transfusion*

The mainstay of management is supportive care with blood and platelet transfusions, as required. Iron chelation therapy for patients with MDS remains controversial. It might be considered appropriate and may improve survival for patients with excessive iron loading (ferritin >1000 micrograms/L) with repeated transfusions (>15–20 units) and with a good prognosis (IPSS low and intermediate-1). The oral iron chelator deferasirox is available for patients who cannot tolerate s/c desferrioxamine.

### *Erythropoiesis-stimulating agents and colony-stimulating factors*

Treatment with the growth factors EPO, darbepoetin, and G-CSF can improve anaemia in a proportion of patients and the neutrophil count in the majority, which may help through the transient use of G-CSF at the time of infections. Patients are predicted to be more likely to respond to erythropoiesis-stimulating agents (ESAs) if they have mild anaemia, no or minimal transfusion requirements (<2 units per month), and a low endogenous EPO level. Seventy per cent of such patients will respond. Patients with ring sideroblasts are more likely to respond to the combination of EPO and G-CSF than EPO alone. Recent retrospective data have suggested that responders to EPO may have a survival advantage.

### *Chemotherapy*

Selected patients with increased blast cells may achieve temporary remission with AML-type chemotherapy. This is most useful in patients with normal cytogenetics and as a way of achieving remission prior to allogeneic transplantation. Patients with MDS seldom tolerate >1 or two courses of combination chemotherapy.

### *Allogeneic stem cell transplantation*

This is currently the only treatment with curative potential and is considered for appropriately fit patients with IPSS score intermediate-2 and high. Conventional myeloablative stem cell transplants are reserved for younger, fitter patients, but recent use of RIC allografts in older patients up to 65y is encouraging. Patients with increased blasts or a clonal cytogenetic abnormality probably benefit from one or two cycles of remission induction chemotherapy prior to transplantation.

### *Hypomethylating agents*

There is excess methylation of gene promoter regions in MDS. This may lead to the inhibition of tumour suppressor genes. Two prospective randomized trials of the hypomethylating agent azacytidine have demonstrated a survival advantage in MDS patients, compared to patients receiving supportive care, low-dose chemotherapy, or remission induction chemotherapy. The European AZA-001 phase III study randomized 179 patients to azacytidine and 179 to best supportive care, low-dose, or conventional chemotherapy. The OS, at a median of 21mo, was 24.4mo versus 15mo, in favour of azacytidine. This is the first time a therapy, other than allogeneic stem cell transplantation, has clearly offered an improved OS in MDS. Azacytidine is licensed for all subtypes of MDS in the US, but the European licence will be restricted to patients with IPSS intermediate-2 and high, CMML with 10–29% blasts, and AML with 20–30% blasts. Azacytidine has been approved for use by NICE and Scottish Medicines Consortium (SMC) and is considered standard of care for high-risk MDS patients not suitable for transplantation.

The karyotypic abnormality deletion (5q) is the commonest abnormality identified in MDS and, as a lone abnormality, is associated with the so-called 5q- syndrome. The accepted pathogenesis for this syndrome is haplo-insufficiency for a number of proteins, including, amongst others, the ribosomal protein RPS14 resulting from a crucial gene loss from the critically deleted area at 5q. The immune modulator drug lenalidomide has recently been shown to alleviate anaemia and produce transfusion independence in 67% of MDS patients with del(5q). Cytogenetic responses and thrombocytopenia on treatment predict for transfusion independence, suggesting lenalidomide suppresses the MDS clone carrying del(5q). Lenalidomide was licensed for this indication in Europe in 2015.

Anti-lymphocyte globulin (ALG) produces impressive responses in some patients with low-risk MDS, including those with a hypocellular marrow, akin to responses in aplastic anaemia.



## Prognosis

The IPSS predicts the prognosis, based on the number of cytopenias (anaemia, neutropenia, and thrombocytopenia), blast cell percentage, and cytogenetic abnormalities (good risk, intermediate risk, or poor risk) (see Table 24.4), which ranges from a few months (patients with excess blasts) to several years (refractory anaemia with ring sideroblasts). Patients die from either transformation to AML or the effects of bone marrow failure and its treatment. This has recently been revised into the IPSS-R, with more discriminatory use of cytogenetic groups and blast percentages. Whilst the IPSS-R improves prognostication, it has not been used, to date, to direct therapy, which is still based on the original IPSS (see Table 24.4).

As in AML, the recent years have seen a surge in the recognition of molecular abnormalities commonly occurring in MDS. These have diagnostic and prognostic implications, e.g. mutations in an RNA splicing gene *SF3B1* occur in >90% of cases with ring sideroblasts, whilst mutations in *TP53* are associated with a very poor prognosis. However, again these are not yet in routine clinical use.

**Table 24.4** IPSS for MDS

Score value	0	0.5	1.0	1.5
Marrow blast (%)	<5	5–10		11–20
Karyotype	Good	Intermediate	Poor	
Cytopenias	0/1	2/3		
The scores for each of the above are totalled to produce the prognostic score and predicted survival as follows.				
Scores	Survival in years for age (y)			
	<60	>60	>70	
Low (0)	11.8	4.8	3.9	
Intermediate-1 (0.5–1.0)	5.2	2.7	2.4	
Intermediate-2 (1.5–2.0)	1.8	1.1	1.2	
High (>2.5)	0.3	0.5	0.4	

## Chronic lymphoid leukaemias

These are a heterogeneous group of conditions associated with the accumulation of lymphoid cells in the peripheral blood. They are classified by the morphology, surface immunophenotype, cytogenetics, and molecular biology. Some lymphomas may present with lymphoid cells in the blood and bone marrow infiltration leukaemic phase. The present WHO classification of mature lymphoid leukaemias is shown in Table 24.5).

### B-cell chronic lymphocytic leukaemia

#### Epidemiology

This is the commonest leukaemia in the Western world. It occurs predominantly in late middle age and old age, with the accumulation of small, mature-looking B-lymphocytes in the peripheral blood, bone marrow, and lymphatic tissues.

CLL accounts for 30–40% of all leukaemias diagnosed in adults in Europe and North America. Annual incidence, 2.5 per 100 000; ♂ to ♀ ratio, 2:1; median age at diagnosis, 65–70y; 79% of patients over 60y at diagnosis. There are no well-defined environmental risk factors. Genetic factors may have a role—compare, e.g. the low incidence of CLL in Japanese people, both in Japan and after emigration. Familial cases are well described.

#### Pathology

Lymphocyte clonal expansion is the result of prolonged survival of CLL cells through failure to respond to apoptotic signals. CLL cells constitutively express high levels of BCL-2 protein, inhibiting apoptosis.

Gradual accumulation of small lymphocytes in the lymph nodes, spleen, bone marrow, and blood causes slowly progressive enlargement of the lymph nodes and infiltration of the spleen and bone marrow. It is possible to distinguish two related subtypes of B-cell CLL (B-CLL). Both arise from B-cells that have rearranged their immunoglobulin genes. However, in one subtype, the leukaemic cells have acquired additional somatic mutations in their immunoglobulin heavy chain variable region genes (*IgVH*), in keeping with antigen affinity maturation (mutated), and, in the other subtype, this has not occurred (unmutated). Other pathological features include:

- a positive direct Coombs' test in some 15%, with clinical autoimmune haemolytic anaemia in a smaller percentage; CLL cells seem adept at presenting rhesus antigens and promoting an immune response to the antigens on red cells
- idiopathic thrombocytopenic purpura (ITP)
- hypogammaglobulinaemia
- disorders of T-lymphocyte function.

#### Clinical presentation

Presentation is variable, but CLL generally runs an indolent clinical course. It is now frequently diagnosed early, often after routine blood count for an unrelated reason. Presentation is with painless lymphadenopathy, anaemia, or infection, e.g. shingles. Constitutional symptoms are restricted to patients with advanced disease, including fatigue, drenching night sweats, and weight loss. In advanced disease, there is bone marrow failure, with variable degrees of anaemia, thrombocytopenia, and neutropenia.

**Table 24.5** Mature lymphoid leukaemias, as classified by WHO**B-cell**

B-cell chronic lymphocytic leukaemia/small lymphocytic lymphoma (B-CLL/SLL)

B-cell prolymphocytic leukaemia (B-PLL)

Hairy cell leukaemia and variants

Splenic marginal zone lymphoma/leukaemia

Leukaemic phase of mantle cell lymphoma

Leukaemic phase of follicle centre cell lymphoma

Leukaemic phase of lymphoplasmacytoid lymphoma

**T-cell**

T-cell prolymphocytic leukaemia (T-PLL)

T-cell large granular lymphocytic leukaemia (T-LGL)

Chronic lymphoproliferative disorders of natural killer (NK) cells

Aggressive NK cell leukaemia

Adult T-cell leukaemia/lymphoma

Leukaemic phase of mycosis fungoides/Sézary syndrome

Reproduced with kind permission of the World Health Organization (WHO). <http://www.who.int>.

Lymphadenopathy is symmetrical, often generalized. Splenomegaly at presentation is present in 66%; hepatomegaly is much less frequent at presentation, but common in advanced disease; involvement of other organs is infrequent at diagnosis. The diagnosis of CLL requires peripheral blood lymphocytosis  $>5 \times 10^9/L$ . Occasionally, patients present with lymphadenopathy without the leukaemic phase, small cell lymphocytic lymphoma (CLL/SCLL).

**Diagnosis**

Updated British Committee for Standards in Haematology (BCSH) guidelines (2012) and NCI Working Group guidelines (2008) recommend the following diagnostic tests:

- FBC and differential
- blood film
- bone marrow aspirate and trephine biopsy
- lymphocyte immunophenotyping
- cytogenetics by FISH, targeted at recognized abnormalities of prognostic significance
- abdominal ultrasound.
- patients should be screened for *TP53* abnormalities prior to therapy. These are present in 5–10% of patients prior to first-line therapy and in more at relapse.

There are NCI working group criteria for the diagnosis of CLL (see Table 24.6). The lymphocyte count is raised, and the blood film shows small lymphocytes with many disrupted 'smear cells'. Surface antigen immunophenotyping is essential to exclude reactive causes (usually T-lymphocytosis) and lymphocytosis due to other lymphoid neoplasms. CLL cells are typically identified as positive for CD19, CD20, CD5, and CD23 and demonstrate weak expression of surface immunoglobulin M (IgM). Cytogenetic abnormalities of prognostic significance include del(11q) and del(17p).

Table 24.6 NCI Working Group revised criteria for diagnosis of CLL

**Peripheral blood lymphocytosis**

1. Absolute lymphocyte count  $>5 \times 10^9/L$
2. Morphologically mature-appearing cells

**Characteristic phenotype**

1. Expansion of CD19<sup>+</sup> and CD20<sup>+</sup> B-cells, CD19<sup>+</sup>, CD5<sup>+</sup>, and CD23<sup>+</sup> co-expressing B-cells
2. Light chain restriction, i.e. monoclonal  $\gamma$  or  $\lambda$  expression
3. Low-density surface IgM (sIgM) expression

**Bone marrow examination**

$>30\%$  of lymphocytes in the bone marrow if peripheral blood lymphocytosis is relatively low, i.e. close to  $5 \times 10^9/L$

**Monoclonal B-lymphocytosis**

The group of Hillmen *et al.* in Leeds has identified circulating clonal lymphocytes in  $\sim 3\%$  of people with normal lymphocyte counts ( $<5 \times 10^9/L$ ); this has also been confirmed by others. The majority of these have the phenotype of CLL cells, and a minority of NHL cells. This finding is more common in the elderly and relatives of those with known CLL. The spectrum of genetic abnormalities is similar to good-prognosis CLL, with the majority carrying mutated *IgVH* genes. The rate of progression to CLL is documented at  $\sim 1\%$  per year.

**Management**

Patients are staged by the Binet system in Europe, and the Rai staging in the US. There is no evidence that treatment prolongs the survival of patients with lymphocytosis or uncomplicated lymphadenopathy (early-stage CLL, Binet stage A), even if associated with poor-risk biological features. Systemic therapy is indicated for symptomatic and advanced disease (progressive Binet stage A or stages B and C).

The BCSH CLL Working Party guidelines (2012) recommend using the International Workshop on Chronic Lymphocytic Leukemia (IWCLL) guidance for initiating treatment, as follows:

- evidence of progressive marrow failure, as manifested by the development or worsening of anaemia and/or thrombocytopenia
- massive (i.e. at least 6cm below the left costal margin) or progressive or symptomatic splenomegaly
- massive nodes (i.e. at least 10cm in longest diameter), or progressive or symptomatic lymphadenopathy
- progressive lymphocytosis, with an increase of  $>50\%$  over a 2mo period or a lymphocyte doubling time (LDT) of  $<6$ mo. In patients with initial blood lymphocyte counts of  $<30 \times 10^9/L$ , the LDT should not be used as a single parameter to define a treatment indication
- autoimmune anaemia and/or thrombocytopenia that is poorly responsive to corticosteroids or other standard therapy

- constitutional symptoms, defined as any one or more of the following disease-related symptoms or signs:
  - unintentional weight loss of 10% or more within the previous 6mo; significant fatigue (i.e. Eastern Cooperative Oncology Group (ECOG) PS 2 or worse; inability to work or perform usual activities); fever  $>38.0^{\circ}\text{C}$  for 2 or more weeks without other evidence of infection; or night sweats for  $>1\text{mo}$  without evidence of infection.

### First-line therapy

When considering therapy, patients should be assessed for fitness and whether or not the CLL has a *TP53* abnormality. For unfit, elderly, non-*TP53*-mutated/deleted patients, the alkylating agent chlorambucil or the nucleoside analogue fludarabine have been most commonly used as first-line therapies. Both can be given orally. Generally, they produce a partial response—a reduction in peripheral blood lymphocytosis and an improvement in the Hb and platelet counts, shrinking of lymphadenopathy and splenomegaly, and an improvement in constitutional symptoms. Alternatives include bendamustine, which has mixed alkylating and nucleoside analogue activity, and combinations of chlorambucil or bendamustine with rituximab which have high response rates and which are approved by SMC in Scotland through a generic approval of the use of rituximab with chemotherapy. To date, bendamustine alone has been shown to have a better response rate and duration than chlorambucil alone, and R-chlorambucil to be better than historical controls.

For fit, non-*TP53*-mutated patients, two phase III trials have established fludarabine, cyclophosphamide, and rituximab (FCR) as the standard of care. The UK CLL4 trial and the German CLL4 trial have previously shown better overall and complete response rates for fludarabine and cyclophosphamide (FC), compared with either chlorambucil or fludarabine used alone, although with higher rates of infective complications and no OS advantage. The German CLL8 trial has reported that FCR is better than FC for the overall response (95% versus 88%) and CR (52% versus 27%), but again there is no difference in the OS at 2y. In most Western practices, FCR has become the first-line therapy for the majority of patients who are deemed fit enough to receive combination chemotherapy.

Fludarabine-based therapy is usually given for 4–6 courses. Fludarabine is profoundly immunosuppressive, especially for the CD4 subset of lymphocytes, and patients are at risk of opportunistic infections, such as herpes viruses and *Pneumocystis jiroveci*, for many months following treatment; patients are given prophylaxis with Septrin<sup>®</sup> and aciclovir for 6–12mo. Alkylating agents or fludarabine-based therapy can trigger autoimmune haemolysis, and they should be used with care in direct antiglobulin (DAT)-positive patients. In the UK CLL4 trial, 10% of DAT-positive patients developed haemolysis, and DAT positivity predicted for the triggering of haemolysis by treatment. Patients treated with chlorambucil or fludarabine were twice as likely to develop haemolysis as those treated with the FC combination, and four haemolytic deaths occurred on fludarabine alone. FC therefore may protect against haemolysis. FC and FCR are heavily myelo-suppressive, and prolonged cytopenias and morphological bone marrow

dysplasia are well recognized, requiring careful monitoring of multiple course therapy, especially in the elderly.

Patients who have *TP53*-mutated/deleted disease at the time of treatment should be treated in appropriate clinical trials or with agents that kill CLL cells in a non-*TP53*-dependent manner. At present, this will be based around the anti-CD52 antibody alemtuzumab.

#### *Corticosteroids*

Single-agent prednisolone (1mg/kg/day) produces a reduction in lymphocytic infiltration of the bone marrow and can result in significant improvement in cytopenias and symptoms. This is a useful initial treatment (1–2wk) for patients with advanced disease and pancytopenia at diagnosis prior to chemotherapy. It is also given for autoimmune haemolysis or thrombocytopenia.

#### *Second-line and subsequent therapy*

Elderly patients relapsing after an initial response to oral chlorambucil/R-chlorambucil/bendamustine/R-bendamustine can be treated again if the first remission is long. Patients refractory to low-dose chlorambucil or with short/poor initial responses should be treated with fludarabine-based therapy, including dose-modified FCR, if feasible. Combination chemotherapy, such as cyclophosphamide, vincristine, and prednisolone (CVP) or cyclophosphamide, doxorubicin, vincristine, and prednisolone (CHOP), is an alternative treatment for patients unsuitable for fludarabine. Patients who develop progressive disease >1y after receiving fludarabine-based therapy and whose CLL responded to fludarabine initially may be treated again with fludarabine based therapy alone or as FC or FCR, provided there is care to observe the blood counts. A multicentre phase III trial randomized relapsed or refractory patients to FCR or FC. Patients could not have received these combinations before. The median PFS was better for FCR (30.6mo versus 20.6mo).

Patients who develop progressive disease within 1y of previous fludarabine-based therapy may be treated with FC or FCR, but second responses are not as good.

Patients who are refractory or become resistant to fludarabine currently have a poor prognosis.

#### *Alemtuzumab*

Alemtuzumab is a chimeric anti-CD52 antibody expressed on a wide range of lymphocytes, including CLL cells. Patients refractory to fludarabine have been treated with alemtuzumab, producing an overall response rate (ORR) of ~40% (10% CR and 30% partial remission), with a prolonged median survival, compared with historical data on fludarabine-resistant patients. Alemtuzumab is licensed for the treatment of fludarabine-failed CLL and is the treatment of choice for patients with a known *TP53* abnormality who respond poorly to other currently available therapies and have a poor prognosis. A randomized trial of first-line therapy with alemtuzumab versus chlorambucil showed better PFS, with time to alternative treatment of 23.3 versus 14.7mo. Alemtuzumab is given for up to 12wk and seems more effective at clearing disease in the blood and marrow than bulky lymph nodes. However, recent phase II data have shown that combining alemtuzumab

with high doses of steroids (CAM-PRED or CAM-DEX) might improve responses in resistant patients and improve responses in bulky disease. Small numbers of patients have been treated with alemtuzumab maintenance. There is improved PFS, but at the cost of significant infection rates, which led to the halting of a randomized phase III trial. Alemtuzumab is profoundly immunosuppressive and is associated with an increased risk of viral infections, including the reactivation of cytomegalovirus (CMV), which should be monitored.

Newer therapies for fludarabine- and alemtuzumab-resistant disease include the anti-CD20 mAb ofatumumab, which is licensed for this indication. However, there is considerable interest in the Bruton's TKI ibrutinib which has shown very encouraging early phase results and is currently undergoing randomized trials.

### **Stem cell transplantation**

Conventional allogeneic transplantation has rarely been carried out in CLL and is associated with a very high TRM (40–70%), predominantly relating to the age of the patients and the co-morbidity associated with previous multiple courses of chemotherapy. However, there does seem to be a GVL effect for CLL, and the use of RIC allografts shows promising early results and should be considered early in treatment planning in patients with poor-risk characteristics such as *TP53* abnormality. Autologous stem cell transplantation (ASCT) can produce very good quality responses, including molecular negativity; however, there is an association with a high rate of treatment-related MDS, and this approach has largely been abandoned in CLL.

### **Radiotherapy**

Radiotherapy is an effective local treatment for lymph nodes compromising vital organ function. Splenic irradiation is effective for painful splenomegaly, although splenectomy is better for massive splenomegaly if the patient is fit for surgery.

### **Splenectomy**

This is effective for massive splenomegaly, anaemia, or thrombocytopenia owing to hypersplenism, and for autoimmune haemolytic anaemia refractory to prednisolone and cytotoxic therapy.

Whilst laparoscopic splenectomy is increasingly used in small or moderate splenectomy, in those cases of massive splenomegaly, open surgery is still sometimes favoured because of the difficulty of access to the pedicle and the risk of massive blood loss. Careful preoperative counselling is required, regarding the risk of infection post-operatively.

Prior to splenectomy, the patient requires pneumococcal, meningococcal, and *Haemophilus* vaccinations. Following splenectomy lifelong penicillin prophylaxis must be given to avoid infection, especially overwhelming post-splenectomy infection (OPSI).

### **Prognosis**

Patients with CLL containing mutated *IgVH* genes have a long median survival of the order of 25y. Patients with CLL containing unmutated *IgVH* genes have a shorter median survival of the order of 8y. The expression of

certain antigens, including CD38 and ZAP-70, is associated with a poorer prognosis, and ZAP-70 expression correlates with *IgVH* gene mutation status. Genetic abnormalities, including del(11q) and del(17p) (*p53* deletion), and resistance to fludarabine are associated with poor prognosis. Small percentages of patients undergo transformation to large B-NHL (Richter transformation) which carries a poor prognosis.

#### *Future directions*

- It is increasingly recognized that the quality of the response in CLL correlates with the length of remission. Data from treatment with high-dose chemotherapy or alemtuzumab have emphasized the importance of achieving a complete response, using sensitive techniques to detect MRD such as 4-colour flow cytometry. Further attempts to reduce MRD burden and affect a cure will involve combinations of antibodies, e.g. ofatumumab and rituximab.
- Maintenance antibody/chemotherapy.
- Bruton's TKIs and combination therapies, including the immunomodulatory drug lenalidomide.





## Hodgkin's lymphoma

### Epidemiology and aetiology

HL is a rare malignancy, with an annual UK incidence of 3 per 100 000. The age distribution in the West shows a large peak in the 20–30y age group, and a smaller peak in old age. In developing countries, there is a higher frequency of childhood cases. There have been associations described with higher socio-economic class, Caucasian race, and previous clinical/severe glandular fever. The cause is unknown and may differ between the various histological subtypes. An association between infection with EBV and HL is well documented. It occurs in about 30% of cases, particularly classical mixed cellularity HL and lymphocyte-depleted HL in older patients.

### Pathology

#### *Classical Hodgkin's lymphoma*

The characteristic diagnostic feature is the binucleate Reed–Sternberg (RS) cell, seen in a variable cellular background of small lymphocytes, eosinophils, neutrophils, histiocytes, plasma cells, and fibrosis. The infiltrating lymphocytes are T-regulatory cells, which favour an anergic-type immune response within the nodal environment, perhaps contributing to the survival of the malignant cells. The RS cell is the malignant cell in HL, and molecular studies have confirmed its B-cell lineage in 97% of cases.

#### *Nodular lymphocyte-predominant Hodgkin's lymphoma*

Nodular lymphocyte-predominant Hodgkin's lymphoma (NLPHL) is a distinct entity, characterized by 'L & H Hodgkin cells', also known as 'pop-corn cells', which are of B-cell lineage and express CD20. ~10% of NLPHL develop into diffuse large B-cell NHL (DLBL). This subtype has a favourable prognosis, although it may run a chronically relapsing and remitting course over many years, akin to low-grade NHL.

The WHO classification of HL is summarized in Table 24.7.

### Presentation

- Painless rubbery lymphadenopathy (cervical nodes especially).
- May be generalized lymphadenopathy.
- Later spread to the liver, lungs, and marrow.
- 'B' symptoms:
  - fever
  - night sweats
  - weight loss >10% over 6mo.
- Other systemic symptoms:
  - itch
  - alcohol-induced pain in lymph nodes (rare).

### Diagnosis

The mainstay of diagnosis is a good-sized lymph node or involved tissue biopsy, which is analysed by expert haematopathologists, using routine morphology and IHC. Fine-needle aspirates may suggest HL but should not be used alone for diagnosis.

**Table 24.7** The WHO classification of HL**Classical Hodgkin's lymphoma**

Nodular sclerosis classical HL (NSCHL)

Mixed cellularity classical HL (MCHL)

Lymphocyte-rich classical HL (LRCHL)

Lymphocyte-depleted classical HL (LDHL)—rare

**Staging**

Spread of HL is typically to contiguous lymph node groups. As a result, anatomical staging, using the Ann Arbor system (see Table 24.8), has been the basis of treatment decisions in HL. The staging procedure now involves a CT scan of the neck, chest, abdomen, and pelvis, rather than laparotomy. Bone marrow involvement is rare at presentation, but more likely with disease below the diaphragm when a marrow trephine should be included in the staging process. PET scanning may be able to replace bone marrow staging. The identification of prognostic factors, other than anatomical staging, has refined treatment decisions, which are now rarely made on the basis of the anatomical stage only.

**Role of 18-fluorodeoxyglucose-positron emission tomography scanning in Hodgkin's lymphoma**

PET scanning has become an integral part of HL management, especially within clinical trials. HL tissue is PET-avid and takes up radiolabelled  $^{18}\text{F}$ FDG, producing an intense positron signal in involved tissue, compared with the background. Patients staged with PET are upstaged in ~16% of cases, but this leads to a change in therapy in a minority, so staging with PET has limited impact on current practice. However, assessment of early response to treatment or end-of-treatment response has significant prognostic bearing. Negative predictive values are high (~80–90%), and positive predictive values are ~60–70%. Such use of PET scanning may allow patient-adapted therapy such as the avoidance of mediastinal radiotherapy in young women with early-stage disease who are PET-negative post-therapy, or the intensification of treatment in patients with advanced disease who remain PET-positive after one or two courses of standard chemotherapy. The less reliable positive predictive value results from a number of causes of false positivity, including inflammation post-radiotherapy, infection, etc. Therefore, long-term monitoring of remission by PET scanning is not recommended.

**Prognostic factors**

Recent studies have identified various presenting factors that may influence the outcome in HL. For patients with early-stage (I and II) disease, several studies have identified prognostic groups, based on the histological subtype, age, sex, symptom status, number of nodal regions involved, and the presence of bulky mediastinal disease (see Table 24.9).

For patients with advanced (stages IIB—IVB) disease, seven prognostic factors have been identified in an analysis of over 5000 patients treated conventionally (see Table 24.10).

Table 24.8 Ann Arbor staging system

Stage	Feature
I	Disease in a single lymph node region
II	Disease in two or more regions on the same side of the diaphragm
III	Disease in two or more regions on both sides of the diaphragm
IV	Diffuse or disseminated disease in extra-lymphatic sites, including the liver and bone marrow

Various suffixes are added to each anatomical stage: A, no systemic symptoms; B, systemic symptoms present; E, extra-nodal disease.

Table 24.9 EORTC prognostic groups in early-stage HL

Group	Prognostic factors
Very favourable	Stage I and age <40y, or 'A' plus ESR <50mm/h, or ♀ and MT ratio* <0.35
Favourable	All other patients
Unfavourable	Age ≥40y, or 'A' and ESR ≥50mm/h, or 'B' and ESR ≥30, or stage II <sub>4/5</sub> , or MT ratio ≥0.35

EORTC, European Organisation for Research and Treatment of Cancer; ESR, erythrocyte sedimentation rate.

\* MT ratio, the size of the mediastinal mass, compared with the transverse diameter of the chest on CXR.

Table 24.10 Adverse factors of the Hasenclever International Prognostic Index for advanced HL

Albumin <40g/dL  
 Hb <10.5g/L  
 ♂ gender  
 Lymphocytes <0.8 × 10<sup>9</sup>/L  
 WCC >15 × 10<sup>9</sup>/L  
 Lymphocytes <15% of total WCC  
 Stage IV

In the absence of any adverse factors, the 5y failure-free survival (FFS) rate is 84%. The presence of each of these factors reduces the expected 5y FFS by about 7%. Having three or more factors is generally considered a poor prognostic group.

## Management

Since HL predominantly affects young adults, potential long-term toxicities of therapy become of major importance now high cure rates are achieved. Several studies of the late effects after HL therapy show that, at 30y of follow-up, twice as many patients have died from second cancers as from relapsed HL, and there is also a relatively high rate of MI. The recognition of the long-term toxicity of radiation therapy, particularly to the mediastinum (second malignancies, including lung and breast cancers, pulmonary fibrosis, coronary artery disease), has led to a major re-evaluation of the use of extensive radiotherapy. The use of mantle radiotherapy (irradiation of extended fields covering all the lymph nodes of the neck, mediastinum, and axillae—44Gy in 22 fractions) in women aged <20y has been associated with breast cancer rates of up to 1 in 3 by age 50y, and such therapy is rarely, if ever, used now. Alkylating agent-based chemotherapy is associated with t-MDS, t-AML, and infertility, and these issues are also taken into account when planning treatment. The aim is to maintain high cure rates but reduce long-term toxicity, especially in early-stage disease.

### *Early-stage (IA and IIA) disease*

The majority of patients with early-stage HL present with supradiaphragmatic disease. For these patients, treatment should be determined by prognostic factors that predict the likelihood of occult subdiaphragmatic disease not detected by routine clinical staging techniques.

Patients with very favourable stage IA NPLHL or nodular sclerosis classical HL involving the high cervical region and a low erythrocyte sedimentation rate (ESR) are at very low risk of occult subdiaphragmatic disease and may be treated with involved field radiotherapy (IFR), maximum dose 30Gy in 15 fractions alone. However, most patients with good-prognosis early-stage HL treated outside a clinical trial would be offered 2–4 courses of standard ABVD (Adriamycin®, bleomycin, vinblastine, dacarbazine) chemotherapy, followed by IFR, 20Gy in ten fractions. In early-stage patients without adverse risk factors, such limited course (2–4 cycles) of ABVD or 'ABVD-like' chemotherapy, combined with IFR, is superior to nodal radiotherapy alone. Using this approach, German and French HL study groups have produced 5y PFS and OS rates of >85% and >90%, respectively. The big question in early-stage HL therefore is whether the same cure rates can be maintained with chemotherapy alone, so removing the long-term complications of radiotherapy. The ECOG study of ABVD versus ABVD plus radiotherapy or radiotherapy alone showed a small PFS advantage for using radiotherapy, without any OS benefit. Therefore, significant numbers of patients may be cured by chemotherapy alone. PET scanning at the end of standard therapy has been shown to have a high negative predictive value (>90%) for relapse of early-stage disease and may allow the selection of PET-negative patients for omission of radiotherapy, without increasing the risk of relapse. The National Cancer Research Network (NCRN) RAPID trial has recently reported initial results showing that early-stage HL patients who are PET-negative after three cycles of standard ABVD chemotherapy do not seem to have an inferior outcome if they are randomized to not receiving subsequent IFR. PET negativity predicted >90% PFS at 3y follow-up in both the irradiated and non-irradiated groups. Patients with early-stage disease, but including poor prognostic features, would be treated like those with advanced disease in many centres.

**Advanced-stage disease (IIB–IV)**

A major trial by the Cancer and Leukemia Group B (CALGB) compared doxorubicin-based chemotherapy as ABVD alone with MOPP (mustine, vincristine, procarbazine, and prednisolone) and MOPP alternating with ABVD. The respective 5y freedom from salvage (FFS) rates were 61%, 50%, and 65%, demonstrating that ABVD and MOPP/ABVD were equivalent, and both superior to MOPP alone. Therefore, in advanced-stage HL, the gold standard therapy has become 6–8 cycles of ABVD, producing PFS rates of 63–87%. It is important that ABVD is delivered optimally. This has been shown to consist of a full dose being delivered every 2wk, without dose reduction or delay for neutropenia and without the need for growth factor support. The German HD9 study showed superior 5y freedom from treatment failure rates of 87% with more intensive dose-escalated BEACOPP (bleomycin, etoposide, doxorubicin, cyclophosphamide, vincristine, procarbazine, prednisolone) chemotherapy, compared with baseline BEACOPP (76%) and alternating COPP/ABVD (69%), although with considerable acute and chronic toxicity, including an increase in t-MDS and more infertility. The OS at 5y was superior for escalated BEACOPP versus COPP/ABVD (91% versus 83%,  $p = 0.002$ ). A mixture of four courses of baseline BEACOPP and four courses of escalated BEACOPP seems to maintain the very high response rates and reduce the rate of t-MDS. In contrast, the UK NCRI study of ABVD versus 12wk of intensive Stanford V regimen has shown no difference in event-free survival (EFS) or OS between the therapies. There was extensive use of radiotherapy in both arms of this study. The key question in advanced-stage HL therefore is whether patients can be stratified into those likely to be cured by the gold standard ABVD from those who need intensification of therapy. The Hasenclever Prognostic Index identifies poor-risk patients with a score of 3 or more. However, recent prospective data from a Danish and Italian study have shown that 50% of patients with poor-risk Hasenclever scores are cured by ABVD, and, in the German studies, the benefit from escalated BEACOPP requires all Hasenclever risk groups to be treated. Using this approach, significant numbers of patients will still be exposed to the complications of treatment intensification who can be cured by ABVD. Therefore, as an alternative approach, the Danish and Italian study explored the use of the PET scan as a dynamic prognostic marker. An early interim PET scan was performed after two cycles of ABVD. Patients who were PET-negative had a 2y PFS of 95%, irrespective of the Hasenclever score. Patients who were PET-positive had a 2y PFS of only 13%, irrespective of the Hasenclever score. Hence, the early interim PET scan may distinguish good-risk advanced-stage patients who should continue treatment with ABVD and may even be able to undergo dose reduction from poor-risk advanced-stage patients who may benefit from dose intensification. The same group has produced retrospective data showing that patients with an early interim PET-2 positive scan have a reduced relapse risk of about 35%, if there is escalation of therapy to the German BEACOPP regimen. This is being tested prospectively in the NCRI RATHL (randomized phase III trial to assess response-adapted therapy using FDG-PET imaging in patients with newly diagnosed advanced HL) trial, which has recently closed but not yet been reported.

### *Role of radiotherapy in advanced Hodgkin's lymphoma*

A total of 333 stages III and IV patients treated with MOPP/ABV who achieved CR were randomized to 24Gy IFR or not. There was no difference in PFS or OS, leading to the standard practice of not offering IFR to advanced-stage patients who achieve CR with chemotherapy. However, a recent analysis of the UK Lymphoma Group (UKLG) LY09 trial, in which patients were randomized to ABVD, alternating ChIVPP/PABLOE (chlorambucil, vinblastine, procarbazine, prednisolone, doxorubicin, bleomycin, vincristine etoposide), or hybrid ChIVPP/EVA (etoposide, vincristine, doxorubicin), challenges this approach. IFR was recommended only for incomplete response or bulk disease. The allocated chemotherapy had no influence on the response rate, PFS, or OS at a median follow-up of 6.5y. The EFS at 5y post-chemotherapy was better for those given radiotherapy (86% versus 71%), and, of most concern, the 5y OS was also superior for receiving radiotherapy (93% versus 87%). The PET scan may, in the future, help clarify which advanced patients will benefit from the addition of radiotherapy, and this is being studied prospectively.

### *Salvage therapy*

The prognosis for the majority of patients with HL of all stages is now very good. However, 30–40% will relapse from CR or demonstrate 1° resistant/refractory disease. Patients relapsing after >12mo in first CR show better responses to salvage chemotherapy than those with shorter first CR. Commonly used salvage regimens include IVE (ifosfamide, etoposide, epirubicin), DHAP (cisplatin, cytarabine, dexamethasone), or ESHAP (cisplatin, cytarabine, etoposide, methylprednisolone). Patients treated with salvage chemotherapy alone have a long-term DFS of only 20–25%, whereas the addition of high-dose chemotherapy and ASCT produces long-term DFS of 40–50% if patients have chemosensitive disease going into the transplant. Results of ASCT are poorer for chemorefractory disease and, as recently recognized, for patients not in functional CR defined by a positive PET scan after salvage. Salvage therapy and ASCT are presently the standard of care for the majority of relapsed patients. Recent data with RIC allografts are encouraging for patients who relapse after ASCT. A UK study compared 38 patients receiving a RIC allograft after failed ASCT with a carefully selected historical control who survived for 12mo post-ASCT and would have nowadays been considered for a RIC allograft. The RIC group had a 5y survival rate from the autograft of 65%, compared to a 5y survival rate from the autograft of only 15% for the historical control. Because of the apparent graft versus HL effect, RIC allografting may be a more appropriate therapy for chemorefractory or PET-positive patients after salvage than ASCT, although, as yet, RIC allografting remains experimental in this situation.

A recent significant addition to the therapy of relapsed disease is brentuximab vedotin. This is an anti-CD30 mAb linked to the mitotic spindle toxin monomethyl auristatin E (MMAE). A pivotal study has shown a 75% response rate to single-agent therapy in HL patients relapsed after autografting. The median survival is 22mo, and this might be a bridge to allografting for some traditionally chemoresistant patients. Brentuximab vedotin cannot be combined with bleomycin because of excess pulmonary toxicity.

*Future directions*

- Removal of radiotherapy for early-stage disease.
- Brentuximab vedotin as a bridge to allografting and in combination with other agents, e.g. replacing bleomycin in ABVD.
- Anti-CD20 and radiolabelled anti-CD20 for the treatment of NLPHL.
- Anti-CD25 to target the infiltrating T-regulatory cells and promote better immune clearance of malignant RS cells.





## Non-Hodgkin's lymphomas

### Definition and aetiology

NHL is a group of malignant diseases arising from lymphocytes and their precursors. The spectrum of NHL ranges from indolent low-grade lymphomas that are incurable, yet compatible with a number of years of survival, to aggressive high-grade lymphomas that, left untreated, are rapidly fatal, but which modern treatment can cure in a significant proportion of patients.

NHL is increasing in frequency, and, in the US, this increase has been 3–4% per annum since early 1970s, with a current incidence of ~15 per 100 000. The pathogenesis of the majority of NHL is unknown, but identified aetiological factors include the following:

- longevity
- prolonged immunosuppression, e.g. congenital immunodeficiencies, HIV-associated NHL, and post-transplant lymphoproliferative disease (PTLD)
- EBV infection in BL, HIV, and PTLD (immunosuppression-related), and human T-cell lymphocytotropic virus (HTLV-1) infection in adult T-cell leukaemia/lymphoma (ATLL)
- *Helicobacter* infection in gastric lymphoma and coeliac disease in small bowel lymphoma
- *Chlamydia* infections in ocular marginal zone lymphomas
- hepatitis C in some marginal zone lymphomas
- regular use of pre-1980 hair dyes.

### Classification of non-Hodgkin's lymphoma

Immunological identification of lymphocytes and molecular analysis of immunoglobulin and T-cell receptor gene rearrangements have allowed an improved classification of NHL, based on the biology of the cells, rather than just the morphological description. The majority of cases of NHL are B-cell type.

The pathological classification currently employed is the WHO classification (see Table 24.11). This is based on whether lymphoma cells are B-lymphocytes or T-lymphocytes, the perceived original cell of origin of the lymphoma, the molecular characteristic of the lymphoma, and whether or not a group of expert pathologists agree that the lymphoma can be reproducibly identified as a distinct entity.

In day-to-day practice, the clinical behaviour of NHL is a useful parameter, and treatment strategies are still based on classification systems that divide NHL into indolent (low-grade) and aggressive (high-grade) diseases. The general differences between low- and high-grade NHL are summarized in Table 24.12.

**Table 24.11** WHO classification of NHL**B-cell lymphoma**

Precursor B-cell neoplasms

Precursor B-lymphoblastic leukaemia/lymphoma

**Mature B-NHL**

Small lymphocytic lymphoma (lymphomatous manifestation of chronic lymphocytic leukaemia)

Lymphoplasmacytic lymphoma

Splenic marginal zone lymphoma

Extra-nodal marginal zone lymphoma of mucosa-associated lymphoid tissue (MALT lymphoma)

Nodal marginal zone lymphoma

Follicular lymphoma

Mantle cell lymphoma

Diffuse large B-cell lymphoma (DLBL)

Mediastinal (thymic) large B-cell lymphoma

Intravascular large B-cell lymphoma

1° effusion lymphoma

Burkitt's lymphoma/leukaemia

B-cell lymphoma, unclassifiable with features intermediate between DLBL and Burkitt's lymphoma, or between DLBL and classical HL.

**T-cell and NK-cell lymphoma**

Precursor T-cell neoplasm

Precursor T-lymphoblastic lymphoma/leukaemia

Mature T-cell and NK-cell neoplasm

*Cutaneous*

Mycosis fungoides

Sézary syndrome

1° cutaneous anaplastic large cell lymphoma

Lymphomatoid papulosis

*Extra-nodal*

Extra-nodal NK-/T-cell lymphoma, nasal type

Enteropathy-associated T-cell lymphoma

Hepatosplenic T-cell lymphoma

Subcutaneous panniculitis-like T-cell lymphoma

*Nodal*

Angioimmunoblastic T-cell lymphoma

Anaplastic large T-cell lymphoma (ALK-positive or negative)

Peripheral T-cell lymphoma, unspecified

*Leukaemic*

T-cell prolymphocytic leukaemia

T-cell large granular lymphocytic leukaemia

Aggressive NK-cell leukaemia

Adult T-cell leukaemia/lymphoma

**Table 24.12** Differences between low-grade and high-grade NHL**Low-grade NHL**

Indolent clinical course with relatively long survival  
 Incurable with present therapy—relapsing and remitting course  
 Non-destructive growth patterns  
 CNS involvement rare

**High-grade lymphoma**

Aggressive clinical course and rapidly fatal without treatment  
 Curable in a significant proportion of patients  
 Destructive growth pattern  
 CNS and extra-nodal involvement common

**Clinical features and staging of non-Hodgkin's lymphoma**

The majority of adult patients (60–70%) present with nodal disease, whereas the majority of children present with extra-nodal disease. One or more areas of lymph nodes are painlessly enlarged and may remain unchanged or slowly increase in size in low-grade NHL, or rapidly increase in size in high-grade lymphomas. Hepatosplenomegaly is common, and extra-nodal sites are protean and include the gut, testes, thyroid gland, bone, muscle, lung, CNS, facial sinuses, and skin. Systemic symptoms include drenching night sweats, loss of weight, and culture-negative fever.

Medical emergencies associated with NHL include mediastinal obstruction, obstructive nephropathy, spinal cord compression, hypercalcaemia, and metabolic derangement. Ascites and pleural effusions (sometimes chylous) are common end-stage features, especially in high-grade NHL. Patients may develop bone marrow failure from lymphomatous involvement, and low-grade NHL can cause immune-mediated haemolysis or thrombocytopenia.

Diagnosis requires a lymph node biopsy or, in the absence of lymphadenopathy, biopsy of an involved extra-nodal site. IHC and cytogenetic and molecular techniques aid morphological diagnosis. Once again, expert haematopathology diagnosis and an MDT review are mandatory.

The extent or stage of the disease should be determined by clinical, rather than pathological (surgical), staging. This involves:

- CXR
- CT scanning of the chest, abdomen, and pelvis to define areas of nodal and extra-nodal involvement
- blood count and blood film for leukaemic involvement
- bone marrow aspiration and trephine biopsy for morphology, immunophenotyping, and cytogenetic analysis
- renal biochemistry, liver function, calcium, and uric acid
- markers of tumour burden—serum LDH and  $\beta 2$ -microglobulin
- others, depending on the circumstances, e.g. CT brain scan, MRI of the spine, lumbar puncture, bone scan.

Clinical staging is based on a modification of the Ann Arbor staging of HL (see Table 24.8). The PET scan is increasingly being used in the staging and response assessment of NHL, particularly in high-grade disease. However, the roles of PET scanning in NHL are less well defined than in HL.

### Low-grade non-Hodgkin's lymphoma

Low-grade lymphomas comprise 20–45% of NHL. They tend to be disseminated at the time of presentation, with widespread lymphadenopathy, hepatosplenomegaly, and often blood and marrow involvement.

#### *Follicular lymphoma*

This is the archetypal low-grade B-cell NHL and the most common subtype of indolent NHL (30% of cases). It typically presents at an older age, although it is also seen in young people. Rarely, it presents as an apparent true stage I when it may be cured by IFR. More commonly, it presents as stage III or IV when it remains incurable in the majority with current treatments but runs a relapsing and remitting course, with an improving median survival of ~12y. This lymphoma can transform to high-grade NHL in 30–60% of cases, which carries a high mortality. High-grade transformation seems to be very rare in patients surviving beyond 15y or so.

The lymphoma cells contain a reciprocal chromosomal translocation— $t(14;18)(q32;q21)$ . This leads to the oncogene *BCL-2*, from chromosome 18, coming under the regulation of the immunoglobulin heavy chain gene (*IgH*) on chromosome 14. The increased production of *BCL-2* protects the lymphoma cell from apoptosis (programmed cell death), and, as such, follicular lymphoma (FL) represents a relentless accumulation of malignant cells.

#### *Management strategies: presentation*

- IFR (24Gy in 12 fractions) for the small number of patients who are apparently stage I. This can be curative, although many patients will prove to have occult systemic disease and relapse.
- For advanced disease (> stage I), avoid chemotherapy-based treatment until significant symptoms. This so-called 'watch and wait' approach remains valid, although it needs to be retested with each new development in 1° therapy. There are some registry data suggesting 'watch and wait' might be associated with an increased risk of high-grade transformation.
- The UK 'Watch and Wait' study has confirmed that single-agent rituximab given to asymptomatic advanced-stage FL patients delays the time to first chemotherapy. However, to date, there is no survival benefit, and this approach remains controversial.

For symptomatic patients (bulky lymphadenopathy, systemic symptoms, cytopenias, organ dysfunction), recent randomized data, confirmed by a meta-analysis, have demonstrated a higher response rate, longer time to disease progression (PFS), and now OS for first-line treatment with rituximab (R)-based immunochemotherapy. Rituximab is a chimeric anti-CD20 mAb. The optimal chemotherapy to combine with rituximab remains unclear, and rituximab is now licensed for use with a range of first-line chemotherapies.

The randomized trial PRIMA (a multicentre phase III, open-label, randomized study in patients with advanced FL evaluating the benefit of maintenance therapy with rituximab (mAb therapy) after induction of response with chemotherapy plus rituximab, in comparison with no maintenance therapy) suggests that R-CHOP produces higher-quality responses, but this part of the trial was not randomized. At present, the mainstays of initial therapy are R-CVP, rather than CVP (cyclophosphamide, vincristine, prednisolone) (at median 53mo: OS 83% versus 77%, time to treatment failure (TTF) 34mo versus 15mo); R-CHOP, rather than CHOP (cyclophosphamide, doxorubicin, vincristine, prednisolone) (at median 18mo: OS 95% versus 90%, TTF not reached versus 29mo); and R-MCP, rather than MCP (mitoxantrone, chlorambucil, prednisolone) (at median 47mo: OS 87% versus 74%, TTF not reached versus 26mo). A recent randomized trial has shown equivalent efficacy between R-CHOP and R-bendamustine as first-line therapy, but with less toxicity in the R-bendamustine-treated patients. R-bendamustine is, as such, an attractive option. Very elderly or infirm patients are still appropriately treated with the oral alkylating agent chlorambucil or R-chlorambucil but may benefit from R-bendamustine.

There may be further benefit for prolonged (2y) rituximab maintenance therapy in first remission, for which it is now licensed. The PRIMA study has confirmed that rituximab maintenance in first remission converts some partial responses to complete responses and prolongs the PFS but, to date, has not produced an improvement in the OS. Many centres now use rituximab maintenance after first-line therapy.

#### *Treatments at time of progression from first response*

As at presentation, there is no rush to treat asymptomatic patients at first or subsequent relapses; watch and wait remains appropriate. There should be a low threshold for repeat biopsy to exclude high-grade transformation. Available therapies are similar to first-line therapy, with some additional options, and include:

- CHOP, CVP, bendamustine, or chlorambucil with or without rituximab
- purine analogues—fludarabine and cladribine, with or without rituximab. The regimen described in CLL (FCR) has become a popular second-line therapy in FL for fitter patients, achieving high response rates. However, prolonged marrow toxicity is common, and stem cell mobilization after FCR can be problematic
- single-agent rituximab (palliation)
- radiolabelled mAb (radioimmunoconjugate)  $^{131}\text{I}$ -anti-B1 (tositumomab) and  $^{90}\text{Y}$ -anti-CD20 (ibritumomab tiuxetan not licensed in the UK)
- patients relapsing from non-rituximab-based first-line therapy show a survival benefit for R-CHOP as second-line therapy, followed by rituximab maintenance every 3mo for 2y or until relapse. Rituximab has a licence for such maintenance therapy in second remission and is approved as such by the SMC in the UK. Whether or not patients receiving rituximab chemotherapy as first line (almost universal now) show the same benefit at relapse is unclear.

### *Role of stem cell transplantation*

- Phase III randomized data for the use of high-dose chemotherapy and ASCT in first remission have demonstrated prolonged PFS versus IFN- $\alpha$  maintenance in the GLSG trial, but not in the GELF94 study, and with no OS advantage to date. ASCT is associated with higher rates of morbidity, including second cancers. Therefore, ASCT is reserved for second and subsequent responses outside of clinical trials.
- The European Group for Blood and Marrow Transplantation (EBMT)-sponsored CUP (conventional chemotherapy, unpurged, purged autograft) study suggests a PFS and OS advantage for randomization to ASCT in relapsed FL (4y OS of 46% versus 71% versus 77% for chemotherapy alone versus unpurged ASCT versus purged ASCT, respectively). However, this study suffered from slow accrual and closed early, with only 140 of a planned 250 recruited and only 89 randomizations.
- There is clearly an allogeneic graft versus lymphoma effect for FL and an increasing interest in RIC allografting for relapsed patients. The EBMT has completed a retrospective comparison of 1394 patients receiving ASCT and 110 patients receiving a RIC allograft for relapsed FL. The RIC patients, not surprisingly, had received more prior lines of therapy, took longer to get to transplant, and were more likely to have refractory disease at the time of transplant. The cumulative 100-day and 1y TRM was 5% and 15%, respectively, for RIC allograft and 2% and 3%, respectively, for ASCT. However, there were no relapses beyond 30mo for RIC allografts, with the 3y and 5y PFS being 62% for RIC allografts versus 58% and 48% for ASCT. The usual story for allografting of higher TRM but reduced relapse risk clearly holds true for relapsed FL with the potential for long-term remission/cure via the graft versus lymphoma effect.
- Patients suffering from high-grade transformation of FL, who respond to salvage chemotherapy and are fit enough, may benefit from ASCT or RIC allografting, and these approaches are commonly pursued in this situation.

In summary, it is clear that patients with FL should be treated with rituximab-based immunochemotherapy as first line and be considered for either rituximab maintenance or stem cell transplantation in second response. The best order of all other palliative therapies is unclear. Given that no therapy is clearly curative, most patients end up receiving all available therapies in a typical relapsing and remitting natural history over several years. Since the quality of the response (negative or low-level MRD) correlates with the length of the response, intensive therapies, like ASCT and RIC allografts, are able to produce long remissions.

### *Prognosis*

- Follicular lymphoma International Prognostic Index (FLIPI) identifies three risk groups, based on five clinical parameters—age, stage, Hb concentration, LDH, and the number of nodal sites. Three prognostic groups are produced, with 10y survivals of ~76%, 52%, and 24%.
- Gene expression profiling provides prognostic information. Interestingly, the gene expression signatures of the infiltrating T-cells and monocytes within the FL node have been shown to predict for survival.

**Marginal zone lymphomas**

After FL and CLL/SCLL, the group of diseases known as marginal zone lymphomas (MZL) are the next most frequent low-grade lymphomas. There are three subtypes recognized:

- *extra-nodal MZL* (most common presentation) involving the stomach, small bowel, salivary glands, thyroid, adnexa of the eye, lung, and other rarer sites. These lymphomas arise in acquired mucosa-associated lymphoid tissue (MALT) resulting from chronic inflammatory stimuli, either infective or autoimmune. Examples include *Helicobacter pylori* in the stomach, *Chlamydia* in the eye, and Sjögren's syndrome with parotid MZL
- *splenic MZL* presenting as splenomegaly, with bone marrow involvement, circulating villous lymphocytes, and a possible association with hepatitis C infection in some parts of the world
- *nodal MZL* (rare).

**Management**

The archetypal gastric MZL without t(11;18) translocation has a high response rate to *H. pylori* eradication. Patients who fail this treatment respond well to IFR. MZL, in general, are very sensitive to radiotherapy, and the treatment of choice for stage I disease at most sites is relatively low-dose (up to 30Gy) IFR. Ongoing trials include tetracycline for *Chlamydia* eradication for eye MZL.

The long-running International Extra-nodal Lymphoma Study Group (IELSG)-19 trial for advanced extra-nodal MZL or failed local therapy has recently reported the final results for the initial randomization between chlorambucil and R-chlorambucil. With a median follow-up of 62mo, R-chlorambucil shows higher response rates and longer EFS, but the 5y OS are identical in both groups (89%).

Splenic MZL are often successfully treated with splenectomy, and nodal MZL are treated similarly to FL in many centres.

**Mantle cell lymphoma**

Mantle cell lymphoma (MCL) accounts for ~6% of NHL. Whilst histologically low grade, it carries the poorest prognosis of all NHL, with a median survival of ~3y. The disease presents predominantly as nodal, although a relatively benign leukaemic form is recognized most commonly in older men. A rarer high-grade blastoid variant is also recognized. Bowel involvement, in the form of multiple lymphomatous polyps, is well recognized. The tumour, like CLL/SCLL, is CD5-positive but carries the hallmark cytogenetic rearrangement t(11;14), leading to an overexpression of cyclin D1 used for diagnosis.

**Management**

Indolent forms can be observed until clinical progression. At first treatment, the decision is taken as to whether or not the patient is fit for ASCT.

For non-transplant patients, CHOP produces poor CR rates of ~30%. A meta-analysis has suggested a benefit in the response rates for the addition of rituximab to front-line chemotherapy, and the German Low-Grade Lymphoma Study Group has shown an advantage in the ORR (92% versus



75%), response duration (29mo versus 18mo), and TTF (28mo versus 14mo), but no OS benefit for R-CHOP versus CHOP.

The European Mantle Cell Study has recently reported that R-CHOP, followed by 2y of rituximab maintenance, produces better OS than FCR, followed by rituximab maintenance, in older patients not considered suitable for high-dose therapy. This benefit was surprising, given the historically poor results with CHOP alone, and seemed to result from lower response rates, higher toxicity (infections), and no maintenance benefit in the FCR arm. A UK National Cancer Research Institute (NCRI) phase III trial compared FCR with FC and demonstrated a survival benefit for FCR.

Therefore, for patients not eligible for high-dose therapy, R-CHOP, followed by rituximab maintenance, seems to be the standard of care, with FCR and R-bendamustine as alternative options.

There are high response rates for regimens using higher doses of cytarabine (ara-C), coupled with high-dose therapy and ASCT, in younger, fitter patients. HyperC-VAD/MTX, followed by ASCT or with rituximab and no ASCT, has produced an OR of 90–100% and CR of 58–100%. Recently, the Nordic Lymphoma Group has treated 160 consecutive patients with alternating R-maxi CHOP/R-high-dose cytarabine, followed by ASCT, in the MCL2 trial. The results are very encouraging, with a median follow-up of 6y, demonstrating a median OS of >10y. However, the earlier hope for a plateau in the survival curve, suggesting cure, looks less likely with longer follow-up.

High-dose cytarabine-based regimens, followed by ASCT, have become the accepted standard of care for younger patients.

### High-grade non-Hodgkin's lymphoma

High-grade NHLs have an aggressive blastic morphology and a strong tendency to involve the CNS and other extranodal sites—lymphoblastic, Burkitt's, ATLL, and 1° CNS lymphoma. The commonest type is DLBL which has an overall rate of CNS involvement of 5%; however, the risk of CNS disease is higher in certain situations: if involving the testes or breasts, involving multiple extra-nodal sites, paraspinal sites, or, controversially, if there is raised LDH. A poor-risk International Prognostic Index (IPI) (score of 3 or more) is a surrogate for these individual risk factors. Such patients require CNS examination and consideration for CNS prophylaxis. Most centres will not give CNS prophylaxis for a raised LDH alone, as this would account for 50% or so of patients, but only if it is associated with other risk factors. The incidence of CNS relapse in DLBL in the era of R-chemotherapy has fallen, and the benefit of CNS prophylaxis has become more controversial, with at least one study suggesting no difference in the CNS relapse risk (~1.6%) for patients receiving prophylaxis. The more rapid clearance of systemic disease by R-chemotherapy may reduce early CNS seeding.

#### *Burkitt's lymphoma*

BL is a highly aggressive B-cell malignancy, characterized by a rearrangement of the *c-MYC* oncogene on chromosome 8 via t(8;14) or a variant translocation. *c-MYC* deregulation leads to a cell cycle fraction approaching 100%, which is commonly used in the diagnostic process, along with cytogenetics,

and a follicle centre phenotype. The disease sometimes presents as mature B-ALL (Burkitt's leukaemia), with distribution in the blood and marrow, rather than lymph nodes and solid organs. Some DLBL have very high cell cycle fractions (>90%), and some of these have *c-MYC* rearrangements. Two epidemiological subtypes of BL are recognized:

- *endemic*:
  - in equatorial Africa
  - 90% associated with EBV infection
  - young adults/children, present with head/neck tumours
- *sporadic*:
  - associated with EBV in ~20%
  - abdominal disease more common
  - occurs as non-HIV-related or HIV-related.

### *Management*

Rapidly cycling, high-intensity multi-agent chemotherapy with a backbone of MTX, cyclophosphamide, and ifosfamide, including CNS prophylaxis, is frequently curative in non-HIV BL. Aggressive management of tumour lysis risk is important, with IV fluids, rasburicase, and regular electrolyte monitoring. The regimen developed by Magrath of CODOX-M (cyclophosphamide, vincristine, doxorubicin, MTX, IT cytarabine) alone for low-risk disease (early-stage and normal LDH) or CODOX-M alternating with IVAC (ifosfamide, etoposide, cytarabine, IT MTX) for poor-risk disease is one frequently used example. Recent UK data from the LY10 trial, using dose-modified CODOX-M/IVAC to limit toxicity, produced a 2y PFS of 64% for non-HIV BL and 55% for BLL. The 2y PFS of low-risk patients rose to 85%. Given the B-cell phenotype, recent attempts to improve outcome have included the addition of rituximab. Twenty-four patients (eight HIV-related) received R-CODOX-M/R-IVAC, producing an EFS and OS of 67% and 75%, respectively, at a median of 19mo. HIV-related BL has a poorer prognosis than non-HIV-related BL. R-CODOX-M/R-IVAC has therefore become the standard of care. Immunocompromised patients are less able to tolerate the regimen toxicity. However, increasing success is seen with the type of regimens described, when used concurrently with highly active antiretroviral therapy (HAART). There is a less toxic infusional regimen known as dose-adjusted R-EPOCH which is also successful in HIV-associated BL, and possibly in non-HIV frailer patients.

### *Lymphoblastic lymphoma*

Presents with or without leukaemia, is commoner in children than adults, and is most often T-cell type, typically featuring a mediastinal mass and pleural effusion. Treatment includes emergency management of mediastinal obstruction and prevention of the tumour lysis syndrome, as described earlier. Intensive combination chemotherapy schedules, similar to those used in ALL and including CNS-directed therapy, have improved the outlook in children, but results in adults remain less good.

Poor prognostic features include bone marrow and/or CNS involvement, LDH >300IU/L, age >30y, and delayed achievement of CR. Allogeneic and autologous progenitor cell transplantation may improve survival in these cases.

### *Diffuse large B-cell non-Hodgkin's lymphoma*

This is the commonest high-grade NHL and accounts for ~40% of all NHL. It presents as nodal disease alone (60%) or as extra-nodal disease (1° extra-nodal DLBL) or with combined nodal and extra-nodal disease.

#### *First-line therapy*

A short course (3–4) of CHOP-like chemotherapy (most commonly, R-CHOP now), followed by IFR (30Gy in 15 fractions), can cure ~90% of non-bulky stage IA disease.

For all other stages, 6–8 courses of R-CHOP have become the gold standard chemotherapy. This follows the landmark Groupe d'Étude des Lymphomes des Adultes (GELA) trial that showed an EFS and OS advantage at 5y for patients over the age of 60y treated with eight courses of R-CHOP (EFS 47%, OS 58%), compared with CHOP (EFS 29%, OS 45%). Similar results have been produced for younger patients. In a German study, CHOP given every 14 days with G-CSF support produced a better CR rate (77% versus 63.2%) and longer TTF than CHOP given every 21 days. However, a large UK NCRI trial, with over 1000 patients randomized to R-CHOP-14 against R-CHOP-21, showed identical OS. Interestingly, toxicity was less in the R-CHOP-14 arm because of the routine use of G-CSF support.

The current standard of care therefore remains R-CHOP-21 for six cycles, with G-CSF support for elderly and frailer patients considered at high risk for neutropenic sepsis. R-CHOP-14 might be considered for younger patients who wish to return to work faster.

Whilst R-CHOP is a milestone development in the first-line management of DLBL, there remain significant issues in patients with advanced poor-prognosis disease, including those with a *c-MYC* rearrangement or double hit lymphomas (*c-MYC* and *IgH-BCL-2*) who fare less well with R-CHOP, and in all patients who relapse after R-CHOP who may be less salvageable than those relapsing from CHOP. Attempts are being made to intensify the first-line therapy for poor-risk patients (IPI  $\geq 3$ ). One example is the UK NCRI trial of modified R-CODOX-M/R-IVAC in such patients. A meta-analysis has failed to demonstrate a benefit for high-dose chemotherapy and ASCT in first remission.

#### *Relapsed diffuse large B-cell non-Hodgkin's lymphoma*

Historically, patients relapsing after CHOP chemotherapy who respond to salvage chemotherapy have been shown to have a survival benefit with high-dose chemotherapy and ASCT, which is the accepted standard of care for patients who are fit. There are a number of widely used salvage therapies, and no one is clearly superior. The addition of rituximab is beneficial in patients who did not receive rituximab in first line. In the GELA study, patients relapsing from the CHOP arm survived longer with R-salvage than salvage alone ( $p = 0.00043$ ), but the benefit was not significant for R-salvage in those relapsing from the R-CHOP arm ( $p = 0.073$ ), with very small numbers. Taking all patients, there was a benefit for R-salvage, and this has become the standard of care. Commonly used regimens are R-ICE (ifosfamide, carboplatin, etoposide), R-DHAP (dexamethasone, high-dose cytarabine, cisplatin), and R-IVE (ifosfamide, etoposide, epirubicin), followed, where possible, by ASCT for chemoresponsive disease. There are

data suggesting no benefit for trying >1 type of salvage therapy if there is chemoresistance, although this is often a difficult decision for physicians and patients to make. The recently completed CORAL trial has compared R-ICE versus R-DHAP followed by ASCT and randomization to maintenance rituximab or not. The study suggests patients relapsing from R-CHOP earlier than 12mo have a very poor outlook, and there is no superiority for either of the salvage regimens. The role of RIC allografting is less clear in DLBL than in HL or FL.

*Prognosis of diffuse large B-cell non-Hodgkin's lymphoma*

- The IPI identifies prognostic groups, based on a score of 1 for each of: age, stage, number of extra-nodal sites, LDH, and performance status. A score of 0/1 is low risk, score of 2 low intermediate risk, score of 3 high intermediate risk, and score of 4/5 high risk. The IPI remains prognostic in the era of R-CHOP, with 4y probability of OS being 95% for IPI 0, 90% for IPI 1, 70% for IPI 2, 55% for IPI 3, and 28% for IPI 4.
- Recent gene expression profiling has had a significant impact on identifying biological subgroups of DLBL, with prognostic importance. A germinal centre signature is associated with a good prognosis, whereas an activated B-cell signature is associated with a poor prognosis.



# Myeloma

## Epidemiology and aetiology

Myeloma (multiple myeloma, myelomatosis) is due to the unregulated proliferation of monoclonal plasma cells in the bone marrow. Their accumulation leads to anaemia and eventually marrow failure, and indirectly to bone resorption resulting in lytic lesions, generalized osteoporosis, and pathological fractures. The cell of origin has not been conclusively identified but may be a memory B-lymphocyte. The cause is unknown.

The overall incidence of the disease is 4 per 100 000 in the UK, but over 30 per 100 000 in subjects over 80y of age. It is higher amongst African-Americans and much lower in Chinese and Japanese Asian populations. It is rare under the age of 40y.

## Pathology

Plasma cell dyscrasias can present in a number of ways:

- monoclonal gammopathy of uncertain significance (MGUS)—paraprotein in serum <30g/L, marrow clonal plasma cells <10%, with no features of myeloma end-organ damage or lymphoma or amyloidosis
- solitary plasmacytoma—either of bone or extramedullary
- asymptomatic myeloma—paraprotein in serum >30g/L and/or marrow clonal plasma cells >10%, but no features of myeloma-related end-organ damage (anaemia, hypercalcaemia, bone lesions, kidney impairment)
- systemic amyloidosis
- multiple myeloma—paraprotein in serum and/or urine, bone marrow clonal plasma cells, and myeloma-related end-organ damage.

Some lymphomas can present with a paraprotein, most commonly lymphoplasmacytic NHL (Waldenström's macroglobulinaemia), but also CLL, MZL, and, less frequently, FL.

The clonal plasma cells in myeloma synthesize, and usually secrete, a monoclonal protein (M protein, paraprotein). This is most commonly intact immunoglobulin but may be immunoglobulin together with free light chain, or free light chain only. IgG is secreted in 60% of cases, IgA in 20%, and free light chain in 20%. Light chains can pass through the glomerular filter, saturate the reabsorption mechanism, and appear in the urine as Bence-Jones protein. In rare cases, there is synthesis of monoclonal IgD, IgE, or IgM, or of two clonal proteins. Also uncommon are non-secretory and non-synthesizing variants of the disease. However, more sensitive methods of detecting free light chain in the serum and urine have suggested that many cases of non-secretory myeloma are, in fact, low-level light chain secretors.

## Clinical features

The accumulation of plasma cells in the bone marrow, the induction of bone resorption, and paraprotein synthesis explain the clinical findings.

### *Marrow infiltration*

Malignant plasma cells accumulate in the red marrow of the axial skeleton and flat bones. Anaemia is common and frequently present at diagnosis. It

results from the combination of anaemia of chronic disease, renal impairment, and bone marrow suppression if the plasma cell burden is high. Overt bone marrow failure is more commonly a feature of end-stage disease.

### ***Bone resorption***

There is abnormal bone remodelling with increased bone resorption and inhibition of osteoblastic bone formation. This leads to the lytic destruction of the skeleton and hypercalcaemia, usually with a normal alkaline phosphatase. The pathogenesis of the osteoclast bone resorption is understood to result from an abnormal cytokine signalling between malignant plasma cells, osteoclasts, osteoblasts, and marrow stromal cells. In particular, increased levels of the receptor activator of NF-kappa B (RANK) ligand, produced by myeloma cells and marrow stromal cells, coupled with a suppression of soluble osteopetegrin (OPG), favour osteoclast bone resorption. Other cytokines, such as IL-6, further support excess osteoclast activity.

Bone pain is the most common presenting complaint, especially severe back pain. There may be fractures of the proximal long bones, ribs, and sternum, and vertebral crush fractures. The increased bone resorption also leads to hypercalcaemia and associated symptoms of thirst, polyuria, nausea, constipation, drowsiness, and even coma. Plain X-ray examination typically reveals osteoporosis and typical lytic lesions that are often visualized on skull films.

### ***Secretion of paraprotein***

Accumulation of M protein in the plasma may result in hyperviscosity, with lethargy and confusion progressing to fits and coma. There is a characteristic retinopathy in hyperviscosity syndrome, with distension of the retinal veins and irregular vessel constrictions; haemorrhages and papilloedema may be present. IgA and IgM (almost exclusively lymphoma-associated) paraproteins are especially likely to induce hyperviscosity, although IgG also if in high level or has IgG3 subclass. Bence-Jones protein is deposited in the renal tubules and leads to renal failure (cast nephropathy). Other factors contributing to renal failure are:

- hypercalcaemia and dehydration
- amyloid deposition
- infection.

Paraproteinaemia is typically accompanied by immunoparesis, which contributes to the infection risk. In non-secretory myeloma, the only immunological abnormality may be immunoparesis, giving rise to diagnostic confusion.

### **Other features**

Plasmacytomas may be palpable and also cause pressure effects. Spinal cord compression is most frequent and constitutes a medical emergency with the need for urgent assessment and local radiotherapy and/or decompressive surgery. Amyloidosis may present as macroglossia, renal failure, peripheral neuropathy, and cardiac failure. A syndrome of high-output cardiac failure is an occasional feature, unrelated to cardiac amyloid.

Very occasionally, the bone lesions appear sclerotic, and this variant of the disease is often accompanied by severe progressive peripheral neuropathy. This combination of sclerotic lesions and neuropathy may also occur as part of the 'POEMS' syndrome where plasma cell dyscrasia is accompanied by:

- sensorimotor polyneuropathy
- organomegaly (principally hepatomegaly)
- endocrinopathy (diabetes mellitus, amenorrhoea, gynaecomastia)
- M protein
- skin changes (predominantly pigmentation).

### Diagnosis

- FBC.
- ESR/plasma viscosity.
- U & Es and serum calcium and albumin.
- Electrophoresis and immunofixation of serum and urine for paraprotein.
- Quantification of intact paraprotein in serum or free light chain in serum for light chain or non-secretory myeloma. This is expressed as a serum free light chain ratio (SFLCR).
- $\beta$ 2-microglobulin quantification.
- Bone marrow aspirate and trephine biopsy.
- Skeletal survey.
- MRI of the spine in cases of isolated plasmacytoma.

The classic diagnostic triad consists of bone marrow infiltration with monoclonal plasma cells, osteolytic lesions on skeletal X-rays, and paraproteinaemia/Bence-Jones proteinuria. For diagnostic purposes, the bone marrow clonal plasma cell count and the paraprotein do not have to be at any given level, provided there is evidence of myeloma-related organ or tissue impairment, including bone lesions. The distribution of plasma cells is notoriously patchy but is often over 30%, usually with morphologically abnormal forms.

Cytogenetic abnormalities, most commonly on chromosomes 13 and 14, and aneuploidy are usually present when analysed by FISH, although their demonstration is not necessary for diagnostic purposes. The myeloma cells tend to be positive for CD38 and syndecan-1 (CD138). Additional common features are:

- raised ESR and rouleaux on a blood film
- normocytic anaemia
- pancytopenia
- renal impairment.

In ~30%, hypercalcaemia is present at diagnosis, and typically the serum alkaline phosphatase concentration is normal and the isotope bone scan negative (due to suppressed osteoblastic activity). The serum albumin may be low.

- The main differential diagnosis is MGUS. Its prevalence is around 20 times higher than that of multiple myeloma, and it is age-related—1% of the population, rising to 3% of subjects over 80y of age, have detectable paraprotein. There is a progression rate to multiple myeloma of 1% per year.
- Asymptomatic myeloma is associated with an initially stable course and a relatively long survival.



In plasma cell leukaemia, there are >20% of plasma cells in peripheral blood. It may be a presenting feature or develop late in the disease course, and it is typically poorly responsive to therapy.

- Solitary plasmacytoma of bone (SBP) presents as a single bone lesion with normal bone marrow, and 60% have a paraprotein, often of low titre. The common sites are the axial skeleton, especially the vertebrae, and include the skull base. Despite normal marrow morphology, recent MRI data have shown that 25% of patients have an abnormal marrow signal at presentation, and MRI of the spine should be performed before delivering radical radiotherapy to SBP. The tumour is radiosensitive, but myeloma subsequently develops in two-thirds of cases.
- Solitary extramedullary plasmacytoma (SEP) is a rare soft tissue plasma cell tumour, occurring most commonly in the upper airways of the head and neck, especially the nasopharynx, sinuses, and tonsils. Again, the bone marrow is normal, and there is no paraprotein in the majority of cases. The tumour is radiosensitive. Multiple myeloma develops less commonly than in SBP, in up to 30% of cases.

## Management

Myeloma remains an incurable malignancy. However, significant developments during the last 15y have led to longer survival and better quality of life. The disease now runs a relapsing and remitting course over several years, somewhat akin to low-grade lymphoma. Untreated, death usually occurs within months, especially from infection and renal failure, and is often preceded by intractable bone pain. Initial therapy should include:

- adequate analgesia, often necessitating the use of opiates, with radiotherapy to areas of persisting local bone pains
- rehydration and vigorous management of hypercalcaemia using IV bisphosphonate. Dialysis is occasionally necessary for the management of renal impairment, and plasma exchange for the rapid correction of hyperviscosity syndrome. The 'MERIT' trial is currently looking at the benefit of early plasma exchange in patients with renal failure
- asymptomatic myeloma does not require therapy but should be monitored carefully, and treatment is initiated on the development of end-organ damage.

### First-line therapy

- Trial-based therapy remains the best approach, where possible. Recent large trials have led to a fundamental switch in approach to novel therapy-based treatment, and the current BCSH guidelines recommend that initial therapy contains at least one of the novel agents thalidomide, lenalidomide, or bortezomib. In 1800 patients recruited to the two age groups of the MRC Myeloma IX study, the addition of thalidomide, in the form of CTD (cyclophosphamide, thalidomide, dexamethasone), improved response rates, compared to CVAD (cyclophosphamide, vincristine, daunorubicin, dexamethasone) or MP (melphalan, prednisolone). CTD is the most commonly used initial therapy in the UK, prior to autografting. Older patients (>65y) and patients not considered for high-dose chemotherapy are, in the majority, treated in the UK with dose-adjusted CTD or MPT (melphalan, prednisolone,

thalidomide). The pivotal trial compared MPT (125 patients) with MP (196 patients) in patients aged 65–75y. With a median follow-up of 51mo, the OS was 51.6mo versus 33.2mo, in favour of MPT, and subsequently MPT has been approved by SMC. Treatment is given until maximum response, assessed by intact paraprotein levels or SFLCR—known as plateau.

- The thalidomide side effects of somnolence, constipation, peripheral neuropathy, and risk of venous thromboembolism (VTE) are important and limit the dose escalation (100–200mg/day), and indeed any use in some patients.
- The proteasome inhibitor bortezomib is also approved for first-line use in the US, but not in the UK. In the VISTA trial, BMP (bortezomib, melphalan, prednisolone) (344 patients) was compared to MP (338 patients), and the median TTP was 24mo, compared to 16.6mo, in favour of BMP, which converted into a reduction in the risk of death of 39% at 16mo follow-up.
- Younger patients in the UK are commonly treated with non-dose-adjusted CTD until maximum response/plateau, usually 4–6 courses, with a view to proceeding in first response to high-dose melphalan (200mg/m<sup>2</sup>) and ASCT. Randomized data from the last 15y have shown increased CR rates and survival benefit for ASCT of about 18mo, pushing the median survivals to 5y and leading to its adoption as standard of care. However, recent analyses suggest the benefit may apply only to those who are not in CR following initial therapy. The move to more effective first-line therapies, based on thalidomide and increasingly bortezomib and lenalidomide, might allow the delay of ASCT until relapse for those who get a CR (no detectable paraprotein and plasma cells <5%) with initial treatment.
- All patients are treated with bisphosphonates as bone protection for up to 1y from the achievement of CR, or lifelong in non-remitters (the majority). Commonly used drugs are oral sodium clodronate or IV pamidronate and zoledronic acid. However, the Myeloma IX trial has shown a significant OS benefit for zoledronic acid (Zometa®) over clodronate, and, as such, Zometa® has become the standard of care for most patients. Important issues during the delivery of care include:
  - prescribing thalidomide and lenalidomide via a risk management programme to prevent exposure of unborn babies. Prescribing thromboprophylaxis to patients on thalidomide and lenalidomide, especially early on when the disease bulk is high and the risk of VTE is of the order of 6%
  - obtaining a dental check prior to giving bisphosphonates and stopping bisphosphonates prior to dental work to minimize the risk of ONJ.
- The role of thalidomide and lenalidomide maintenance in first plateau has been investigated. In the UK Myeloma IX trial, the PFS was improved with maintenance thalidomide in all treatment groups, but with no OS benefit. Patients not achieving at least a very good partial remission after ASCT might benefit from maintenance thalidomide, and this is supported in the current BCSH guideline, but it is not generally

recommended for any other groups. It may be detrimental to patients with the cytogenetic abnormality del(17p).

- Lenalidomide maintenance has been shown to delay progression after autograft. However, its cost effectiveness is not proven. Furthermore, there are data suggesting that lenalidomide increases the incidence of second solid malignancies in myeloma. The EMA has issued a warning relating to this, and, whilst the risk–benefit analysis continues to favour its use with dexamethasone in myeloma, they have stated that lenalidomide should not be prescribed outside of its licensed indications. As such, lenalidomide maintenance is not generally used in the UK at present.
- IFN- $\alpha$ , administered as maintenance therapy, appears to extend the duration of the plateau phase, according to a meta-analysis. However, this is probably not a meaningful survival, being of the order of 3mo, especially given that the therapy is associated with significant side effects and impinges on the QoL. As such, it is not recommended in the current BCSH guideline.

Allografting in myeloma remains controversial. Conventional allografting carries an unacceptably high TRM. Recent data with RIC allografting, including some randomized data, are more encouraging, and studies looking at RIC allografts in younger patients at a time of MRD post-ASCT are ongoing.

#### *Treatment of relapse/progressive disease*

New agents have offered significant benefit in the palliation of progressive disease. The proteasome inhibitor bortezomib (Velcade®) produces responses in one-third of pre-treated patients. An open-label randomized study of 669 patients with progressive myeloma after 1–3 prior therapies has shown a benefit for bortezomib over high-dose dexamethasone. The median TTP was 189 days versus 106 days, with an OS, at a median of 22mo of follow-up, of 29.8mo versus 23.7mo. Bortezomib is approved for second-line therapy in the UK in patients who have received or are unsuitable for ASCT. Bortezomib is also regularly used as part of first-line therapy when there is renal failure and other drugs are more difficult to apply.

The second-generation immunomodulatory drug lenalidomide, when combined with dexamethasone, produced better TTP (11.3mo versus 4.7mo) and OS (35mo versus 31mo), compared to placebo and dexamethasone, in previously treated patients. It produces responses in patients who have failed thalidomide. Lenalidomide with dexamethasone has a licence for use in first relapse of myeloma in the UK and is currently being compared as part of first-line therapy (CRD) against CTD in the NCRN Myeloma XI trial.

Patients progressing after ASCT may benefit from a second high-dose therapy and ASCT. Tandem transplants in close succession probably offer little benefit over repeat ASCT at progression. The physical and psychological morbidity of two ASCTs needs to be taken into account.

Older therapies, including weekly cyclophosphamide and single-agent dexamethasone, remain useful palliative treatments for some in the advanced multiply treated setting.

**Additional therapies**

- Pain control is very important. Analgesics, oral when possible, should be given, as appropriate, for the level of pain. These range from regular paracetamol to high doses of long-acting morphine, identified through the titration of short-acting morphine. NSAIDs should be avoided because of their potential renal toxicity.
- IFR is given for intractable bone pain and pressure effects such as cord compression. Long bone fractures should be surgically stabilized and then treated with IFR. Very precarious lytic lesions within long bones may benefit from prophylactic surgical pinning.
- A recent promising surgical development is kyphoplasty, which allows the re-expansion of collapsed vertebrae with a balloon, followed by the support of the collapsed vertebrae with injectable cement.
- EPO can be used to reduce transfusion requirements, with responses of the order of 70%, especially in patients with renal failure. The cost has limited its use within the UK, and recent concerns over the use of EPO in solid tumours have led to added caution.

**Prognosis**

A number of prognostic factors have been identified to predict survival in myeloma. A system based on  $\beta$ 2-microglobulin levels and albumin has been accepted as the international staging system for predicting prognosis (see Table 24.13).

**Table 24.13** New international staging system for myeloma

Criteria	Median survival (mo)
I. Serum $\beta$ 2-microglobulin <3.5mg/L (296nmol/L) and serum albumin >3.5g/dL (532 micromoles/L)	62
II. Neither I or III <sup>a</sup>	45
III. Serum $\beta$ 2-microglobulin >5.5mg/L (465nmol/L)	29

<sup>a</sup> There are two subcategories: serum  $\beta$ 2-microglobulin <3.5mg/L, but serum albumin <3.5g/dL; or serum  $\beta$ 2-microglobulin 3.5–5.5mg/L, irrespective of the serum albumin level.

## Further reading

- Hoffbrand AV, Catovsky D, Tuddenham EGD, Green AR (eds.) (2010). *Postgraduate haematology*, 6th edn. Oxford: Blackwell Publishing.
- Swerlow SH, Campo E, Harris NL, et al. (eds.) (2008). *WHO classification of tumours of haematopoietic and lymphoid tissues*. Lyon: IARC Press.
- Wiernick PH, Goldman JM, Dutcher JP, Kyle RA (eds.) (2013). *Neoplastic diseases of the blood*, 5th edn. New York: Springer.



# Bone and soft tissue malignancies

Reference centres for bone sarcomas 604

Osteosarcoma 606

Ewing's sarcoma 612

Other primary bone tumours 616

Soft tissue sarcomas 620

Rhabdomyosarcoma 626

## Reference centres for bone sarcomas

Bone sarcomas are an uncommon group of malignancies, often requiring complex multi-modality treatment, so that centralization of their management has been accepted in the UK for almost 30y.

All patients with a suspected bone sarcoma should be referred for diagnosis and have their care managed at a reference centre by a fully accredited MDT. *This is a core principle of the NICE guidance 'improving outcomes for patients with sarcoma'. Currently, there are five such reference centres in England.*

This approach to the diagnosis of bone sarcomas avoids the risk of improperly performed biopsies and allows increased use of molecular diagnostic techniques. Networks should ensure that GPs and hospital doctors are aware of the referral criteria and referral pathways for suspected bone sarcomas. Patients with a provisional diagnosis of bone sarcoma should have their radiology and pathology reviewed by a specialist radiologist and pathologist, members of the relevant sarcoma MDT.

Patients with a confirmed diagnosis of bone sarcoma have their care supervised by the sarcoma MDT, with support from the relevant children's or teenage/young adult MDT, where appropriate, with surgery, chemotherapy, and radiotherapy planned by the sarcoma MDT and delivered by MDT-approved specialists. Many of these patients are best managed within international clinical trials, in particular those with osteosarcoma or Ewing's tumour.





## Osteosarcoma

### Epidemiology and aetiology

Malignant bone tumours are rare, around 600 new cases per annum in the UK. They account for only 0.2% of all new cancers, but 5% of childhood cancers and 15% of extracranial malignancies in adolescents. Osteosarcoma is the commonest 1° bone tumour, accounting for 20%.

- Bimodal distribution—75% under 20y, second peak >60y.
- Occurs predominantly in adolescence, with a peak incidence coinciding with the growth spurt.
- Cases occurring over the age of 40y are usually associated with a recognized predisposing lesion:
  - Paget's disease
  - irradiated bone
  - multiple hereditary exostoses
  - polyostotic fibrous dysplasia.
- ♂:♀ ratio 1.6:1.
- Usually arise in the metaphysis of long bones.
- 60% arise around the knee.

### Pathology

- Composed of malignant spindle cells and osteoblasts that produce osteoid or immature bone.
- The 'classic' subtype is a central medullary tumour.
- Rarer types with a better prognosis include parosteal, periosteal, and low-grade intraosseous osteosarcoma.
- Local invasion into the medulla and through the bony cortex.
- Soft tissue extension, less often joint space invasion.
- Vascular invasion is common.
- Typical sites for metastatic disease are the lung and bone.
- 75% have occult or overt metastatic disease at presentation.

### Genetics

Occasionally, associated with Li–Fraumeni syndrome (germline mutation of p53) or hereditary retinoblastoma.

### Presenting symptoms and signs

- Most present with pain at the tumour site.
- May have associated bone or soft tissue swelling.
- Overlying erythema and tenderness.
- Pathological fracture infrequently.

### Investigations

Plain X-rays of the affected area are often sufficient to suggest the diagnosis of osteosarcoma. The classic radiological features of osteosarcoma are:

- poorly delineated or absent margins around the bone lesion
- periosteal reaction, usually non-continuous and thin, with multiple laminations
- new bone formation with calcification of the matrix
- bone destruction.

There are no specific tumour markers, but serum alkaline phosphatase is elevated in 50% of cases.

NB Histological confirmation of the radiological diagnosis of a 1° bone tumour must be deferred, until the patient is assessed by a surgeon with expertise in the management of bone malignancies.

### Staging investigations

- MRI scan to assess the local extent of the tumour, intramedullary tumour, skip metastases along the bone, and soft tissue extension.
- CT of the chest for lung metastasis.
- Isotope bone scan.

Several staging systems for bone tumours exist, the most commonly used being that combining TNM staging and the pathological grade of the tumour (see Table 25.1).

Table 25.1 Staging of bone tumours

Stage	T stage	N stage	M stage	Pathological grade
1A	T1	N0	M0	Low grade
1B	T2	N0	M0	Low grade
2A	T1	N0	M0	High grade
2B	T2	N0	M0	High grade
3	T3	N0	M0	Any grade
4A	Any T	N0	M1a	Any grade
4B	Any T	N1	Any M	Any grade
	Any T	N0	M1b	Any grade

#### TNM staging

T0, no evidence of 1° tumour

T1, tumour 8cm or less in maximum dimension

T2, tumour >8 cm in maximum dimension

T3, discontinuous tumours in the bone

N0, no regional lymph node metastasis

N1, regional lymph node metastasis

M0, no distant metastasis

M1a, pulmonary metastasis

M1b, extrapulmonary metastasis

**Management of patients with osteosarcoma**

Surgical resection (usually amputation of a limb) alone was used to treat osteosarcomas until the 1970s. The OS was only 15–20%, largely because of pulmonary metastatic disease. Subsequent use of chemotherapy in the adjuvant (post-operative) or neoadjuvant (pre- and post-operative) setting has improved the 5y survival rate to 55–70%. Surgical management has also improved in the past 30y, with amputation being replaced in the majority of patients by limb-sparing surgery, usually with endoprosthetic replacement of the resected bone. These prostheses are now customized to the individual patient. There are now detailed UK guidelines for the management of osteosarcoma and other bone sarcomas.

**Preoperative assessment**

- All patients with osteosarcoma should be managed within a specialist bone tumour MDT setting.
- A biopsy of the suspected osteosarcoma must be performed by an orthopaedic specialist with experience of this technique. In 1990, only 20% of patients referred to MD Anderson Cancer Center had correctly placed biopsy sites. Today, most patients have the biopsy performed by a specialist, either an orthopaedic oncology surgeon or a radiologist.
- Ideally, the biopsy should be performed by the surgeon who will undertake the definitive resection.
- Trephine or core biopsy is recommended.
- Potential tumour contamination of all tissue planes and compartments traversed by the biopsy needle, so the biopsy tract will have to be removed en bloc during the definitive resection, along with a cuff of healthy tissue.
- An incorrectly sited biopsy may necessitate amputation, instead of limb-sparing surgery.
- Angiography may be necessary when limb-sparing procedure is planned to determine the individual vascular pattern before resection, especially with proximal tibial lesions.

**Chemotherapy**

The outcome for patients with osteosarcomas has been markedly improved with the addition of chemotherapy to surgery. The most active agents are:

- doxorubicin
- cisplatin
- high-dose MTX
- ifosfamide.

Chemotherapy is commonly given pre- and post-operatively. This has several potential benefits:

- treatment starts without delay (the production of a customized endoprosthesis takes several weeks)
- the tumour volume may be reduced by chemotherapy, making surgery easier
- allows the pathological assessment of the response to chemotherapy in the resected tumour, with the possibility of introducing alternative cytotoxics post-operatively.

Typically, 2–3 cycles of chemotherapy are delivered, followed by surgery, followed by a further 3–4 cycles of chemotherapy.

### Surgery

Sarcomas grow radially and produce a pseudocapsule. Osteosarcoma invariably spreads through the capsule, and expert surgery is necessary to ensure en bloc resection with wide clear margins to remove all viable tumour.

Intralesional surgery is to be avoided for osteosarcoma, as it is associated with a high risk of both local and distal recurrence.

As a result of advances in imaging, biomedical engineering, and preoperative chemotherapy, there has been a major shift away from amputation for osteosarcoma. The majority of limb osteosarcomas are now treated successfully with limb-sparing techniques. A wide variety of endoprosthetic devices are available, including extendable prostheses for growing children. In many specialist centres, allografts and metallic prostheses are used as composites to obtain the best functional outcome.

Limb-sparing resection requires:

- no involvement of major neurovascular bundle
- wide resection of the affected bone
- en bloc removal of previous biopsy sites
- resection of the bone 4cm beyond the CT, MRI, bone scan uptake evidence of the tumour
- resection of the adjacent joint
- adequate muscle reconstruction, with or without transfers.

Whilst vascular reconstruction is possible, having to sacrifice mixed nerves is a limiting step in the functional preservation of the limb. Relative contraindications to limb-sparing surgery include major neurovascular involvement, pathological fractures (tumour cells spread via the haematoma), infection, and extensive muscle involvement.

A patient presenting following the excision of a tumour thought to be benign but which turned out to be malignant on histology should be considered for further limb salvage surgery.

### Radiotherapy

Osteosarcomas are relatively radioresistant tumours. Radiotherapy is rarely used in the 1° treatment of this disease. Its use is limited to:

- high-dose palliative treatment for patients who refuse surgery or for axial osteosarcomas that are not resectable
- adjuvant therapy after surgery and chemotherapy when excision has been marginal
- palliative treatment of bone metastases.

### Metastatic osteosarcoma

Around 15% of new cases have metastatic disease at presentation. With combination chemotherapy, followed by resection of the 1° and, when feasible, resection of metastatic disease, long-term survival can be achieved in 20–30%.

Careful follow-up of patients with localized disease is essential. In general, patients will be reviewed at least 3-monthly in the first 2y, 4-monthly in years 3 and 4, and 6–12-monthly in years 5–10. Each follow-up will include a review of ongoing/new problems, a physical examination, an assessment of the limb function and late toxicities, and a CXR.

- Most patients who relapse have pulmonary metastases, and, in ~60%, the lungs are the only site of disease.
- Up to 43% of relapsing patients may be salvaged by surgical resection of the metastases.
- Metastasectomy may be considered for multiple and bilateral lung deposits and on >1 occasion. However, the long-term results of pulmonary metastasectomy for sarcomas (bone and soft tissue) remain inconclusive.
- Local recurrences are managed by surgical resection (usually amputation) or palliative irradiation.
- The role of chemotherapy after surgery for relapsed disease is uncertain.
- The outcome of palliative treatment with second-line chemotherapy for unresectable tumours is poor.

### **Treatment outcomes and prognostic factors**

- Operable localized disease—60–70% 5y survival:
  - limb conservation does not compromise survival, compared with amputation.
- Metastatic disease—10–30% 5y survival.
- Better prognosis with limb versus axial 1°.
- Tumour size similarly influences survival.
- Response to chemotherapy:
  - a good response of >95% cell kill in the resected specimen conveys a 5y survival of 80% and is seen in ~60% of patients with current regimens
  - a poor response to chemotherapy conveys a 5y survival of 40–50%.

### **Recent developments**

A worldwide cooperative study, examining the benefits of maintenance IFN after MAP (high-dose MTX, doxorubicin, cisplatin) chemotherapy and of chemotherapy intensification, with the addition of ifosfamide and etoposide in poorly responding tumours after surgery—the EURAMOS-1 (European and American Osteosarcoma Study Group) trial—completed recruitment of more than 2200 cases in 2011, but analysis of the poorly responding tumour group shows no benefit from post-operative treatment including ifosfamide and etoposide. Muramyl tripeptide phosphatidyl-ethanolamine (MTP-PE) is a synthetic lipophilic analogue of muramyl dipeptide, which is a component of the cell wall of BCG. MTP-PE has been encapsulated in liposomes and appears to enhance the efficacy of post-operative chemotherapy for osteosarcoma. This agent and the bisphosphonate zoledronic acid are likely candidates for trial in the next study.



## Ewing's sarcoma

First described by James Ewing, a New York pathologist, in 1926. This is another rare, but highly malignant, 1° bone tumour. Until the introduction of combination chemotherapy in the 1970s, 90% of patients with this diagnosis died, usually from metastatic disease.

### Epidemiology and aetiology

- Annual incidence of 0.6 per million.
- 6–10% of all 1° bone tumours.
- Less common in non-Caucasians.
- Peak age 10–20y.
- The aetiology is unknown.
- Not associated with cancer family syndromes.
- May affect any bone; 55% arise in the axial skeleton.
- May also arise in soft tissue.

### Pathology

The Ewing's sarcoma family of tumours includes:

- Ewing's tumour of the bone
- peripheral PNET
- Askin tumour (arising on the chest wall).

They are believed to arise from neural crest cells. Microscopy shows small round blue cells, with rosette formation and positive staining for:

- MIC2 (CD99)
- neural markers (NSE, S100)
- glycogen (periodic acid–Schiff, PAS).

Typically, they arise in the diaphysis of long bones or in flat bones, e.g. the pelvis, invade through the medulla, but also extend through the cortex to form a significant soft tissue extraosseous mass in at least 50%. Blood-borne spread to the lung and bone is common, and 20–25% have overt metastases at presentation. Microscopic systemic disease is present in the majority of patients with radiologically localized disease.

### Genetics

More than 95% have rearrangement of chromosome 22 involving the *EWSR1* gene, usually an 11;22 translocation, to produce an oncogenic transcription factor.

### Presenting symptoms and signs

- Painful bony swelling.
- Overlying tissues warm and red.
- Axial lesions may cause pain with compression of the abdominal organs, urinary tract, or nerve.
- 10% have fever and a hot swollen limb, mimicking osteomyelitis.

### Investigations

- Plain X-ray typically shows a destructive, osteolytic lesion, with periosteal elevation, although 25% have a sclerotic component.



- MRI scan demonstrates both an osseous and extraosseous disease extent.
- May have anaemia, elevated ESR/C-reactive protein (CRP), and high LDH.
- Patients with suspected bone malignancy must be referred to an orthopaedic oncologist for biopsy—an inappropriate biopsy siting can result in tumour spillage and unnecessary requirement for limb amputation.
- Core biopsy, with material sent fresh to the laboratory to allow cytogenetics.

### Staging

- CT of the chest and abdomen.
- Isotope bone scan.
- MRI of the 1° lesion and any hot spots identified on bone scan, with an estimate of the 1° tumour volume.
- Bone marrow aspirate ( $\times 2$ ) and trephine from sites distant from known disease.

Prior to therapy, tests of normal organ function should include:

- FBC and biochemistry
- renal function (ethylenediaminetetra-acetic acid (EDTA) clearance)
- ECG and left ventricular ejection fraction (MUGA test or echocardiogram)
- pulmonary function tests
- viral titres.

### Management of Ewing's tumours

All patients should be managed in a cancer centre with appropriate multi-disciplinary expertise and experience. They should, wherever possible, be treated within multi-institutional trials, currently in Europe the Euro-Ewing 99 study.

Broadly, management consists of:

- initial chemotherapy, e.g. six cycles of VIDE—vincristine, ifosfamide, doxorubicin, etoposide
- local therapy to the 1° tumour, e.g. surgery, radiotherapy, or both (chemotherapy continues, concomitant with radiotherapy)
- further chemotherapy (up to another eight cycles of conventional chemotherapy or high-dose therapy with peripheral blood stem cell support).

### Chemotherapy

Over the last 20y, dose intensification and incorporation of new cytotoxics have led to significant improvement in the outcome of treatment, but at the cost of significant toxicities.

- Venous access requires a Hickman line, Portacath, or portable intensive care (PIC) line.
- Profound myelosuppression occurs in all patients during chemotherapy.
- The risk of neutropenic sepsis is reduced by the prophylactic use of G-CSF and antibiotics.
- *Pneumocystis jiroveci* prophylaxis is required.

- Febrile neutropenia must be treated promptly with broad-spectrum antibiotics.
- Close attention to hydration, anti-emetics, and mouth care.
- Careful monitoring of renal, hepatic, and cardiac function.
- Risk of graft-versus-host reaction; blood products must be irradiated before use, and leucocyte filters used for transfusion.
- These young patients require considerable psychosocial and educational support.

#### *Local therapy of the primary tumour*

Surgery should be considered in all cases, and, if it is possible to remove the entire tumour without undue mutilation, then it is the local treatment of choice. In the North American COG trial, 65% of patients were treated by means of surgery alone as local treatment. Surgical developments mean that there are few bones in the body that are not amenable to surgery, including the pelvis.

Radiotherapy may be used as an adjuvant to surgery when excision margins are close (44–54Gy in 1.8Gy fractions), this combined approach accounting for 15% of patients. In the remaining 20% with opposition to amputation or in whom the tumours were deemed not resectable, radiotherapy alone may be employed (54–64Gy) The volume irradiated includes the original tumour with 2–5cm margins, often shrinking the volume after 44Gy.

#### *Management of metastatic disease*

Patients presenting with metastatic disease are managed initially, as described earlier, with induction chemotherapy, followed by local therapy to the 1° tumour.

- Patients with lung metastases may then be treated with conventional chemotherapy and whole-lung irradiation (18Gy in ten fractions) or high-dose chemotherapy, e.g. busulfan and melphalan, with peripheral blood stem cell support.
- Patients with bone or marrow metastases have a poorer prognosis, and high-dose chemotherapy may be considered for many of these.

#### *Follow-up and management of disease recurrence*

These patients require careful and regular multidisciplinary follow-up, in order to pick up on any late toxicities of treatment, as well as disease recurrence. Local recurrence in the absence of metastatic disease may be salvaged by surgery, and similarly isolated lung metastasis should be considered for pulmonary resection. Most recurrences are, however, unresectable, and, for these, further chemotherapy should be considered, ideally within a clinical trial.

### **Treatment outcomes and prognostic factors**

- 5y survival:
  - localized disease, 55–65%
  - metastatic disease, 10–20%
  - lung only metastases, 30%.

The major prognostic factors are:

- metastases at presentation
- the site and volume of the 1°:
  - tumour <100mL in a long bone, 80% 5y survival
  - pelvic tumour, 30% 5y survival
- the pathological response to chemotherapy
- local therapy (surgery better than radiotherapy).

### Late effects

- Cardiomyopathy (anthracyclines).
- Nephrotoxicity (ifosfamide).
- Infertility.
- Second malignancy (leukaemia, osteosarcoma).

## Other primary bone tumours

Most often malignant fibrous histiocytoma, but other pathologies include liposarcoma, angiosarcoma, leiomyosarcoma, and haemangiopericytoma.

- All are rare, <1% of all bone tumours.
- Arise in any bone (usually the metaphysis of a long bone).
- Occur mainly in middle age.
- Can occur after a previous insult to the bone, e.g. ionizing radiation, bone infarct, or fibrous dysplasia.

The treatment is surgical removal of all disease, but, as with osteosarcoma, limb-sparing surgery and insertion of a customized endoprosthesis may be feasible. The role of adjuvant chemotherapy has been established in malignant fibrous histiocytoma, using agents including doxorubicin and cisplatin, or ifosfamide in preoperative therapy, with positive results. Greater than 90% necrosis in the resected bone is reported after chemotherapy in ~40%.

Metastatic disease may require:

- lung resection for solitary metastasis
- palliative chemotherapy using the above agents.

### Chondrosarcoma

- Cartilage-forming malignancy.
- Tumours of middle to late age.
- Second commonest 1° bone tumour (~20%).
- Typically presents with a painful enlarging mass in the pelvis, proximal femur, humerus, or ribs; unusual in distal bones.
- The grade is a good guide to behaviour, although about 10% of low-grade tumours transform to a higher grade.
- Surgical resection remains the mainstay of treatment. For intermediate- and high-grade lesions, en bloc excision, with limb conservation whenever possible, is the optimal treatment. For low-grade lesions, extensive intralesional curettage, followed by local treatment with phenol or cryosurgery and filling of the cavity with bone graft, has shown promising long-term results, in terms of function and oncological outcomes.
- No proven role for adjuvant chemotherapy.
- Radiotherapy after incomplete resection or palliation of advanced disease.
- Grade 1, 5y survival of 90%; grade 3, 40%.
- Metastatic disease is difficult to manage unless confined to 1-3 lung metastases amenable to surgical removal. Metastatic chondrosarcoma is resistant to conventional chemotherapy agents (doxorubicin, cisplatin). Some tumours are ER-positive and may respond to anti-oestrogen therapy.

### Chordoma

- Slow-growing tumour that arises from notochord remnants.
- Accounts for 2-4% of 1° bone tumours.
- Sited in the sacrum/coccyx (50%), skull base/clivus (35%), or upper cervical vertebrae.
- Presents in middle age with persistent pain.
- Often only discovered on CT or MRI after 'normal' plain X-rays of the bone.

- Metastases are rare (lung or bone)
- Survival determined by the success or failure of local control.
- Surgery is the treatment of choice but may not be feasible due to the location of the tumour. It is important to ensure that the 1° surgery achieves clear margins, as local recurrence rates are high.
- Sacrococcygeal lesions are best treated by a combined abdominoperineal approach, with excision of the sacrum one level higher than the lesion.
- Radiotherapy (55–60Gy) after incomplete resection or as palliation. It is also provided routinely to lesions of the base of the skull and the sphenoid-occipital region.
- Particle therapy with protons has shown promise and should be considered for unresectable and incompletely resected lesions.
- 30–50% survive 5y, but late recurrences are possible.

### Solitary plasmacytoma

- Isolated painful lytic bone lesion, rich in plasma cells.
- Age 50–60y, ♂ > ♀ (2:1).
- Diagnosis depends on the exclusion of myeloma (no other skeletal lesions, no hypercalcaemia, no suppression of other immunoglobulins, and bone marrow contains <5% plasma cells).
- Paraproteinaemia is common.
- Treatment is with radiotherapy (40–45Gy).
- Prognosis is good; median survival of 10y.
- Follow-up important, as 50% developed multiple myeloma.

### Primary bone lymphoma

- 3% of 1° bone tumours; 2% of all NHL cases.
- Age 50–70y.
- Painful lytic or mixed lytic sclerotic bone lesion.
- Core biopsy shows malignant, small, round, dark cell tumours of the bone (differentiate from, e.g. Ewing's, metastatic neuroblastoma).
- Staging with CT, bone scan, and bone marrow examination is required to exclude systemic lymphoma.
- Localized high-grade NHL is treated with initial chemotherapy, together with radiotherapy (see Chapter 24).
- The role of surgery in lymphoma is limited. It may be considered in truly isolated lesions, in which case limb-sparing surgery and endoprosthesis insertion may be considered. Prostheses are particularly useful in long weight-bearing bones where there is otherwise a high risk of fracture. Surgery has also been advocated for residual or recurrent disease, following radiation, and in the treatment of pathological fractures.
- 5y survival of 60%.

### Metastatic bone disease

In adult patients, metastatic carcinomas considerably outnumber 1° bone tumours, but, where there is any diagnostic uncertainty, e.g. a solitary bone lesion in the absence of other metastatic disease in a patient previously treated for a localized cancer, referral for a biopsy to exclude 1° bone sarcoma is appropriate. Management of metastatic bone disease is dependent on the 1° pathology (see relevant chapters for metastatic prostate, breast, lung cancer, etc.).

**Further reading**

- Burchill SA (2008). Molecular abnormalities in Ewing's sarcoma. *Expert Rev Anticancer Ther* **8**, 1675–87.
- Fuchs B, Ossendorf C, Leerapun T, Sim FH (2008). Intercalary segmental reconstruction after bone tumour resection. *Eur J Surg Oncol* **34**, 1271–6.
- Gobel V, Jurgens H, Etspuler G, et al. (1987). Prognostic significance of tumor volume in localized Ewing's sarcoma of bone in children and adolescents. *J Cancer Res Clin Oncol* **113**, 187–91.
- Granowetter L, Womer R, Devidas M, et al. (2009). Dose-intensified compared with standard chemotherapy for nonmetastatic Ewing sarcoma family of tumors: a Children's Oncology Group Study. *J Clin Oncol* **27**, 2536–41.
- Grimer RJ (2005). Surgical options for children with osteosarcomas. *Lancet Oncol* **6**, 85–92.
- Grimer R, Athanasou N, Gerrand C, et al. (2010). UK Guidelines for the Management of Bone Sarcomas. *Sarcoma* **2010**, 317462.
- Hogendoorn PC, ESMO/EUROBONET Working Group (2010). Bone sarcomas: ESMO Clinical Practice Guidelines for diagnosis, treatment and follow-up. *Ann Oncol* **21** (Suppl 5), v204–13.
- Iwamoto Y (2007). Diagnosis and treatment of Ewing's sarcoma. *Jpn J Clin Oncol* **37**, 79–89.
- Kelley SP, Ashford RU, Rao AS, Dickson RA (2007). Primary bone tumours of the spine: a 42-year survey from the Leeds Regional Bone Tumour Registry. *Eur Spine J* **16**, 405–9.
- Lietman SA, Joyce MJ (2010). Bone sarcomas: overview of management, with a focus on surgical treatment considerations. *Cleve Clin J Med* **77** (Supp 1), 8–12.
- Meyers PA, Schwartz CL, Krailo MD, et al. (2008). Osteosarcoma: the addition of muramyl tripeptide to chemotherapy improves overall survival: a report from the Children's Oncology Group. *J Clin Oncol* **26**, 633–8.
- Paulussen M, Bielack S, Jurgens H, Jost L (2009). Ewing's sarcoma of the bone: ESMO clinical recommendations for diagnosis, treatment and follow-up. *Ann Oncol* **20** (Suppl 4), 140–2.
- Ritter J, Bielack SS (2010). Osteosarcoma. *Ann Oncol* **21** (Suppl 7), 320–5.
- Schuck A, Ahrens S, Paulussen M, et al. (2003). Local therapy in localized Ewing tumors: results of 1058 patients treated in the CESS 81, CESS 86, and EICESS 92 trials. *Int J Radiat Oncol Biol Phys* **55**, 168–77.
- Scully SP, Temple HT, O'Keefe RJ, Scarborough MT, Mankin HJ, Gebhardt MC (1995). Role of surgical resection in pelvic Ewing's sarcoma. *J Clin Oncol* **13**, 2336–41.
- Skubitz KM, D'Adamo DR (2007). Sarcoma. *Mayo Clin Proc* **82**, 1409–32.
- Treasure T, Fiorention F, Scarci M, Møller H, Utley M (2012). Pulmonary metastatectomy for sarcoma: a systematic review of reported outcomes in the context of Thames Cancer Registry data. *BMJ Open* **2**, pii, e001736.



## Soft tissue sarcomas

### Epidemiology

- Rare; ~1200 cases per annum in the UK.
- 1% of adult cancers, 6% childhood cancers.
- 15% occur in children; fourth commonest childhood cancer.
- Age distribution depends on the pathology:
  - rhabdomyosarcoma in children/young adults
  - synovial sarcoma in young adults
  - MFH and liposarcoma in older adults.

### Aetiology

- Genetic associations:
  - neurofibromatosis type 1 predisposes to malignant peripheral nerve sheath tumour
  - hereditary retinoblastoma;
  - Li–Fraumeni syndrome (germline mutation of *p53*).
- Radiation exposure, usually therapeutic many years previously, e.g. angiosarcoma following breast irradiation.
- Rarely, chemical exposure (vinyl chloride, herbicides, dioxins).

### Pathology

Although the histological classification is complex, staging and management are similar for most. Histological grading is crucial. Low-grade sarcomas rarely metastasize, grow slowly with the development of a pseudo-capsule, and may be dealt with successfully by surgery alone. High-grade sarcomas are locally invasive, may recur after surgery, and metastasize typically to the lung by blood-borne spread. High-grade tumours account for 50% of sarcomas, and, of these, 50% die of metastatic disease. Lymphatic spread is less common but may occur in epithelioid or synovial sarcoma or rhabdomyosarcoma. Fresh tissue for cytogenetic analysis may assist in the classification of soft tissue sarcomas (see Table 25.2).

### Presenting symptoms and signs

- Most present with a painless soft tissue mass.
- 45% lower limb, 15% upper limb, 10% head and neck, 15% retroperitoneal.
- Any enlarging mass, deep to the deep fascia, should be regarded as a potential sarcoma.
- However, up to 30% of soft tissue sarcomas are subcutaneous.

### Investigations

- Imaging with MRI to assess the local extent of the tumour mass and its relationship to adjacent structures, including blood vessels and nerves.
- CXR and CT of the chest, looking for lung metastases.
- Core biopsy and imaging should be performed, before an attempt is made to excise any potentially malignant soft tissue tumour. The only exception to this rule may be retroperitoneal and pelvic sarcomas where a core biopsy may carry the risk of tumour spillage and spread.
- Multidisciplinary planning of individual patients' management is crucial, involving the pathologist, radiologist, site specialist surgeons, and clinical and medical oncologist.



### Pathological classification of soft-tissue sarcomas

- Alveolar soft part sarcoma (ASPS).
- Angiosarcoma.
- Clear cell sarcoma.
- Dermatofibrosarcoma protuberans (DFSP).
- Desmoplastic small round cell tumour.
- Epithelioid sarcoma.
- Extrasosseous Ewing's tumour.
- Extraskeletal chondrosarcoma.
- Extraskeletal osteosarcoma.
- Fibrosarcoma.
- Gastrointestinal stromal tumour (GIST).
- Kaposi's sarcoma.
- Leiomyosarcoma.
- Liposarcoma.
- Malignant fibrous histiocytoma (MFH).
- Malignant giant cell tumour of the tendon sheath.
- Malignant haemangiopericytoma.
- Malignant peripheral nerve sheath tumour (MPNST).
- Malignant solitary fibrous tumour.
- Rhabdomyosarcoma (RMS).

Table 25.2 Cytogenetic abnormalities in sarcomas and the genes involved

Sarcoma	Translocation	Genes involved
Ewing's tumours	11;22	<i>EWS-Fli1</i>
Liposarcoma (myxoid and round cell)	12;16	<i>TLS (FUS)-CHOP</i>
Synovial sarcoma	x;18	<i>SYT-SSX1 and 2</i>
Rhabdomyosarcoma (alveolar)	2;13	<i>PAX3-FKHR</i>
Clear cell sarcoma	12;22	<i>EWS-ATF1</i>

**Staging system**

- Combination of grading, tumour size, and evidence of metastatic spread (see Table 25.3).
- The 1° tumour is staged by size:
  - T1 <5cm
  - T2 >5cm.

**Table 25.3** Staging of soft tissue sarcomas

Stage groupings	Tumour grade	1° tumour	Lymph node status	Metastasis
I	G1	T1–2	N0	M0
II	G2	T1–2	N0	M0
III	G3	T1–2	N0	M0
IVA	Any	Any	N1	M0
IVB	Any	Any	N0	M1

**Management of soft-tissue sarcomas**

There are now comprehensive guidelines for the management of soft tissue sarcomas.

**Surgery**

Ideally, localized sarcomas are managed by complete surgical excision with clear margins and en bloc removal of any biopsy tract. Sarcomas are now referred to regional specialist units if surgical management is being considered. For limb tumours, surgery is classified, according to its extent, by the Enneking criteria:

- *intralesional or intracapsular*—the excision passes through the tumour with involved margins, and the risk of local recurrence approaches 100%; most commonly, such procedures are performed without a preoperative diagnosis of sarcoma and without preoperative imaging. The outcome for patients managed in this way is significantly poorer than with appropriately planned radical excision. They require urgent referral to an orthopaedic oncologist, usually for staging and imaging of local residual disease and more radical surgery
- *marginal*—tumour shelled out through the pseudo-capsule; recurrence rate of 20–70%, depending on the tumour pathology
- *wide excision*—wide margin of local tissue removed, along with the tumour; adequate for low-grade sarcoma, but up to 30% recurrence rate with high-grade disease, usually due to unsuspected non-contiguous tumour extension beyond the surgical field
- *radical excision*—en bloc dissection of the tumour and muscular compartment; low risk of local recurrence but may lead to unacceptable loss of function. Resection limits of 2cm of uninvolved tissue are now adequate (previously, attempts were made to excise full muscle from the origin to insertion). Skin and bony involvement are unusual

- *limb amputation*—infrequently indicated, if the disease cannot be completely excised with conservation of a functional limb. The amputation rate was 50% in the 1960s and is now 5%. Current data at 10y show that, whilst local recurrence is higher with limb salvage surgery, there is no difference in the DFS.

For the majority of soft tissue sarcomas arising at other sites, surgery is the mainstay of local treatment. Locally advanced disease not amenable to 1° surgery may be treated with preoperative radiotherapy or chemotherapy in order to facilitate resection. Surgery may also be appropriate for local recurrence and metastatic disease, in particular solitary pulmonary metastasis.

### **Chemotherapy**

The majority of adult soft tissue sarcomas are only moderately chemosensitive. The most active agents are doxorubicin and ifosfamide, with response rates of 10–30% to these agents, either singly or in combination, in advanced disease. The role of adjuvant chemotherapy remains controversial, with little evidence to support its use in an effort to improve cure rates. For some specific pathologies (e.g. extraosseous Ewing's/PNET), chemotherapy has a major impact on survival; the benefits of chemotherapy in other adult sarcomas are less clear. A meta-analysis has examined data from 14 trials involving >1500 patients. Although adjuvant chemotherapy reduces the risk of disease recurrence (by 10% at 10y), no significant survival benefit has been demonstrated. Progress in this field is likely to be dependent on an improved understanding of the biological differences between the various pathologies and the individualization of therapy, according to molecular predictors of behaviour and response to treatment.

### **Radiotherapy**

Most adult soft tissue sarcomas are only moderately radiosensitive. The most important role for radiotherapy is in the post-operative adjuvant setting, particularly for high-grade sarcomas treated by wide excision. Even when excision margins are clear, non-contiguous microscopic residual tumour may be present within the muscle compartment. Post-operative radiotherapy to the conserved limb may be delivered using a shrinking field technique—phase I 50Gy/25 fractions, phase II 10–16Gy. A strip of normal tissue along the length of the limb should be left unirradiated to reduce the risk of chronic lymphoedema. Lower doses of radiation are given following the resection of retroperitoneal sarcomas, limited by the normal tissue tolerance of the abdominal contents (e.g. 50Gy/25 fractions). A number of investigators are examining the potential benefits of intraoperative radiotherapy after resection of sarcomas at a number of sites.

### **Targeted therapies**

GISTs are the commonest sarcomas in the GI tract and account for 5% of soft tissue sarcomas.

- Incidence of 10–20 per million.
- 20–30% malignant.
- Most commonly arise in the stomach or small bowel.
- Rarely familial or associated with neurofibromatosis type 1 or Carney's triad.

- The majority have a gain-of-function mutation in the proto-oncogenes *c-kit* or *PDGFR $\alpha$* , leading to the constitutive activation of their receptor TK.
- Imatinib inhibits KIT and *PDGFR $\alpha$*  TK.
- Surgery is the mainstay treatment of GISTs, and complete resection is the only potentially curative therapy. As the tumour rarely metastasizes to lymph nodes, nodal dissection is not required, and organ-sparing surgery is often possible.
- In a study of 127 patients, the 5y recurrence-free survival was 63%.
- Factors associated with recurrence include tumour size >10cm, mitotic rate of 5/50 high power fields, and tumour originating from the small intestine.
- Intraperitoneal rupture or bleeding are associated with local recurrence rates of close to 100%.
- Inoperable recurrence or metastatic disease is unresponsive to conventional chemotherapy, with a median survival of 10–20mo.
- The objective response rate in such patients treated with imatinib 400mg daily is ~50%, with a median survival time of >3y.
- Common mild/moderate toxicities—oedema, anaemia, nausea, lethargy, diarrhoea, skin rash, myelosuppression.
- Imatinib-resistant disease can respond to increased-dose imatinib (albeit with increased toxicity).
- Some evidence that even resistant disease benefits from continued therapy, with a rapid acceleration of tumour growth after cessation of imatinib.
- Other receptor TK-targeted agents, e.g. sunitinib, have demonstrated activity in imatinib-refractory disease. Regorafenib targets several TK signalling pathways and has also shown promise in advanced GIST refractory to imatinib and sunitinib.
- Individualization of therapy may be possible in the next few years, according to the mutation of *c-kit*.
- Trials of adjuvant therapy have been completed, and, following resection of high-risk GIST (based on the tumour size and mitotic count), adjuvant imatinib is recommended to be prescribed for 3y (approved by SMC, but not by NICE).
- Imatinib also active against unresectable dermatofibrosarcoma protuberans (DFSP).

### **Treatment outcome and prognostic factors for soft tissue sarcomas**

Treatment outcomes worse with:

- large tumours
- deep versus superficial tumours
- high-grade sarcoma
- intralesional excision
- visceral/retroperitoneal versus limb 1°
- metastatic disease at presentation.

Overall, the 5y survival is around 70%, but 50% for stage III, and around 20% for stage IV. Patients who relapse with only pulmonary metastasis may be cured by metastasectomy.



## Rhabdomyosarcoma

- Commonest soft tissue tumour in childhood and adolescence.
- >50% in children under 10y.
- Rare in adults over 40y.
- ♂:♀ ratio 1.3:1.
- Arises from primitive mesenchymal cells with the capacity for rhabdomyoblastic development.
- Commonest sites of origin are:
  - the head and neck
  - the genitourinary tract
  - retroperitoneal
  - the extremities.
- The disease is locally invasive (e.g. spreads from the orbit to the meninges and CNS).
- Disseminates to the lymph nodes, lungs, bones, marrow, and brain.
- Aggressive malignancy requiring multi-modality treatment.
- The outlook depends on the disease site and histological subtype.
- All cases should be managed by an experienced sarcoma MDT within a cancer centre.

### Diagnosis

- Presents with soft tissue swelling or other local symptoms, e.g. displacement of the eye, vaginal bleeding, or dysuria.
- For histological diagnosis, it is advisable to obtain fresh tissue for chromosomal studies.

### Embryonal rhabdomyosarcoma

- About 60% of cases.
- Mainly in children under 15y.
- Head and neck (including orbit), genitourinary tract, retroperitoneal.
- Spectrum of cells, from primitive round cells to rhabdomyoblasts.
- Botryoid rhabdomyosarcoma is a subtype characterized by polypoid growth, like a 'bunch of grapes', usually found in hollow organs, e.g. vagina, bladder, and nasopharyngeal sinuses.

### Alveolar rhabdomyosarcoma

- Poorly differentiated round or oval cells, forming irregular spaces and separated by fibrous septae, giving the appearance of 'alveoli'.
- Sometimes this appearance is absent, but the uniform appearance of the cells is distinct from that of the embryonal variety.
- Diagnosis may be confirmed by the presence of a t(2;13) (q37;q14) or variant t(1;13) (p36;q14) chromosomal translocation.
- Significantly worse prognosis than embryonal rhabdomyosarcoma.

### Pleomorphic rhabdomyosarcoma

- Rare adult soft tissue tumour.
- Behaves similarly to other adult soft tissue sarcomas.
- May be curable, if localized, with surgery and radiotherapy.
- Poor prognosis for locally advanced or metastatic disease.

**Table 25.4** Prognostic factors in rhabdomyosarcoma

Good	Poor
Orbit, paratesticular, vagina, extremities	Parameningeal, retroperitoneal
Localized to tissue of origin	Contiguous spread, nodal or metastatic disease
Complete resection feasible	Unresectable
Embryonal histology	Alveolar histology
Infant or child	Adult
Complete response to chemotherapy	Poor response to chemotherapy

### Staging

- MRI or CT of the 1° site.
- CT scan of the thorax.
- Isotope bone scan.
- Bone marrow aspirate and trephine.
- Stage is usually assigned using the SIOP–International Union Against Cancer (UICC) TNM (tumour, nodes, metastases) staging system.

### Prognostic factors

The prognosis in rhabdomyosarcoma depends on the pathology, site, size, extent of spread, and response to chemotherapy (see Table 25.4). Overall, the 5y survival has improved considerably, from 25% in the 1960s to 70% currently, largely through the introduction of systemic chemotherapy.

### Management

Treatment is tailored according to the prognosis, balancing the need for effective local and systemic treatment against the late morbidity, particularly of radiotherapy and chemotherapy.

#### Chemotherapy

- Often given as neoadjuvant therapy prior to definitive local surgery.
- Vincristine and dactinomycin only for good-prognosis disease.
- Other drugs added for worse-prognosis disease (e.g. ifosfamide, doxorubicin).
- High-dose chemotherapy may have a role in metastatic disease.

#### Local treatment

- Surgery, with complete removal of all local disease and lymph node sampling, is the optimal therapy. Extensive surgery involving significant morbidity is *not* essential in embryonal rhabdomyosarcoma, as this tumour is radio- and chemosensitive.
- Surgery may not be feasible because of the tumour extent or because it may lead to unacceptable mutilation/loss of function.
- Given concomitant with chemotherapy, radiotherapy doses of 40–50Gy will achieve local disease control.

- However, serious long-term sequelae are associated with the combined-modality treatment in children:
  - late damage to sensitive organs, e.g. bladder, eye, brain, testis, ovary, thyroid
  - risk of second malignancy
  - impaired bone growth.
- Radiotherapy may be safely omitted in infants and children with localized favourable-prognosis disease, e.g. embryonal rhabdomyosarcoma of the orbit.
- Extremity tumours, alveolar histology, and parameningeal tumours require radiotherapy.

### Further reading

- Casali PG, Jost L, Sleijfer S, Verweij J, Blay JY; ESMO Guidelines Working Group (2008). Soft tissue sarcomas: ESMO clinical recommendations for diagnosis, treatment and follow-up. *Ann Oncol* **19** (Suppl 2), ii89–93.
- Dematteo RP, Gold JS, Saran L, et al. (2008). Tumor mitotic rate, size, and location independently predict recurrence after resection of primary gastrointestinal stromal tumor (GIST). *Cancer* **112**, 608–15.
- Enneking WF, Soanier SS, Goodman MA (1980). A system for the surgical staging of musculoskeletal sarcoma. *Clin Orthop Relat Res* **153**, 106–20.
- Grimer R, Judson I, Peake D, Seddon B (2010). Guidelines for the management of soft tissue sarcomas. *Sarcoma* **2010**, 506182.
- Lietman SA (2010). Soft-tissue sarcomas: overview of management with a focus on surgical treatment considerations. *Cleve Clin J Med* **77** (Suppl 1), 13–17.
- Siegel HJ, Sessions W, Casillas MA, Said-Al-Naief N, Lander PH, Lopez-Ben R (2007). Synovial sarcoma: clinicopathologic features, treatment, and prognosis. *Orthopedics* **30**, 1020–5.



# Malignancy of unknown primary

Definitions 630

Epidemiology and aetiology 631

Pathology 632

Management aims 634

Investigation of metastases to lymph nodes and peritoneum 636

Investigation of metastases to other sites 638

Investigation of a pleural effusion 640

Management of carcinoma of unknown primary 642

Further reading 644

## Definitions

In order to standardize the approach to the patient with malignant disease of unknown origin, NICE has produced clinical guidelines (see ➔ Further reading, p. 644). The aim was to define the clinical entity and optimize patient investigation and management. The following definitions have been set out:

- *malignancy of unknown primary (MUP)*—‘metastatic malignancy, identified on clinical examination or imaging, without an obvious primary site’
- *provisional carcinoma of unknown primary (provisional CUP)*—‘metastatic malignancy of proven epithelial, neuro-endocrine or undifferentiated lineage, after initial but not exhaustive investigations’
- *confirmed carcinoma of unknown primary (confirmed CUP)*—‘metastatic malignancy of proven epithelial, neuro-endocrine or undifferentiated lineage, after completion of all appropriate tests’.

## Epidemiology and aetiology

- Common oncological problem representing up to 10% of all referrals.
- ~10 500 cases of CUP in England and Wales per year (Cancer Research UK data).
- Fourth commonest cause of cancer death.
- ♂ > ♀.
- The median age at presentation is ~60y.
- Third commonest cancer presentation in those aged ≥70y. Rare if aged ≤40y.
- The clinical presentation is usually with symptoms arising from the site of metastasis.
- Undetected 1° site most likely due to unusual metastatic potential of the tumour. Occasionally, there has been regression of the 1° (well recognized in melanoma). The 1° may remain undetected, even after post-mortem examination (25%).
- The pattern of metastatic disease is often very different from cases where the 1° site is known, e.g. lung cancer causes bone metastases ten times more often when the 1° site is known than when the lung cancer is occult.
- Median survival of 4mo in most series. However, some clinical scenarios are associated with much longer survival, and it is these that are important to identify.
- The diagnosis encompasses tumours from many 1° sites with varying biologies.

### Favourable prognostic factors

- ♀ sex.
- Fewer sites of metastatic disease, especially lymph node/soft tissue, rather than liver/bone.
- Good performance status.
- Normal serum LDH, albumin, and WCC.

## Pathology

- Causes include:
  - carcinomas, including:
    - adenocarcinoma
    - SCCs
    - neuroendocrine tumours
    - germ cell tumours
  - melanoma (in 5% of cases, no 1° is identified)
  - lymphoma.

### Light microscopy

Light microscopy can help identify:

- Carcinomas, including:
  - adenocarcinoma (60–70%)
  - SCCs (<5%)
  - germ cell tumours
  - neuroendocrine tumours
  - poorly differentiated carcinomas (20–30%)
  - can be confused with:
    - seminoma
    - amelanotic melanoma
    - epidermal carcinoma
- Undifferentiated malignancy (<5%)—which requires further staining to exclude lymphoma.

### Immunohistochemistry

- Essential where germ cell cancer or lymphoma are possibilities.
- Initial panel of stains likely to use antibodies to:
  - CEA
  - PSA
  - cytokeratin
  - vimentin
  - common leucocyte antigen (CLA), e.g. CLA stain can usually make the distinction between carcinoma and lymphoma (see Table 26.1).
- ER/PR staining should be requested if the presentation is compatible with metastatic breast cancer. However, other 1° sites may be ER/PR-positive, e.g. ovarian or endometrial.
- May help decide between possible 1° sites, although unfortunately few stains are specific, e.g. neuroendocrine markers and chorionic gonadotrophin may be found on many tumours, other than SCLC and germ cell cancer, respectively.

### Electron microscopy

- Useful for distinguishing lymphoma from carcinoma.
- Can sometimes assist in identifying neuroendocrine tumours, melanomas, and poorly differentiated sarcomas.

### Genetic analysis

- A promising technique, but currently not in mainstream clinical use.
- Gene expression-based profiling should not be used when deciding which treatment to offer patients with cancer of unknown 1°.
- The identification of specific genetic abnormalities is limited to a few tumours at present, e.g. Ewing's sarcoma, rhabdomyosarcoma, NHL.

Table 26.1 Site-specific immunohistochemical stains

Stain	Tumour
CLA	Lymphoma
B- and T-cell gene rearrangement	NHL
PSA	Prostate
TG	Thyroid

## Management aims

- Exclude potentially curable malignancies, e.g.:
  - thyroid cancer
  - lymphomas
  - breast cancer.
- Perform only investigations that will change management. Before arranging any investigation, it is important to ensure:
  - the results are likely to affect a treatment decision
  - the patient understands why the investigation is occurring
  - the patient understands the potential benefits/risks of investigation and treatment
  - the patient is prepared to accept treatment
  - the patient would be fit enough for treatment
  - e.g. colonoscopy in a patient without obstructive bowel symptoms, but with metastatic adenocarcinoma of probable lower GI origin, may not influence the treatment choice.
- Identify specific clinical syndromes that predict responsiveness to therapy (~20% of all cases of CUP), e.g.:
  - SCC metastatic to cervical lymph nodes is treated as advanced head and neck cancer.
- Patient-centred care is the priority.

## Initial management

Before accepting the diagnosis of cancer of unknown 1° site, it is important that all patients undergo:

- a thorough history, including detailed family history
- a full physical examination to include the following areas:
  - breast
  - skin
  - nodal areas
  - pelvic/genital
  - rectal
- minimum additional investigations, which are likely to include:
  - FBC
  - serum biochemistry, including LFTs
  - CXR
- further investigations, which should be guided by the patient's symptoms and may include:
  - myeloma screen (if bone lesions identified)
  - CT scan of the chest, abdomen, and pelvis
  - endoscopy—if symptoms consistent with a GI 1°
  - CXR
  - USS/CT scan of the abdomen
  - testicular USS
  - mammography—if the scenario compatible with breast cancer

- the analysis of tumour markers should be limited to, and dependent on, the clinical scenario, e.g.:
  - PSA in some men
  - CA125 in women with ascites or peritoneal malignancy
  - AFP/ $\beta$ -HCG if germ cell tumour a possibility
- all cancer centres and cancer units should have a CUP team, with a named lead clinician. This team should be involved early in the patient's pathway and will play an important role in coordinating the patient's care. The hospital's acute oncology service will be able to offer advice in the interim.

## Investigation of metastases to lymph nodes and peritoneum

Metastases to lymph nodes are commoner than presentation with visceral/bony metastases. Appropriate investigation of specific clinical presentations is critical for optimizing treatment, and hence prognosis. Some cancers presenting in this way remain curable.

### Axillary lymph nodes in women

- Metastatic adenocarcinoma in axillary lymph nodes may indicate an occult breast cancer, even with a negative mammogram.
- Patients should be referred to a breast cancer MDT for discussion.
- MRI of the breasts is often recommended if the mammogram is normal.
- Tissue from the axillary lymph nodes should be obtained by:
  - ultrasound-guided core biopsy (most common)
  - FNA
  - open biopsy
  - ER and PR staining should be performed on the biopsy sample.
- In the absence of distant metastatic disease, management is as for stage II breast carcinoma and is likely to include:
  - loco-regional therapy with surgical excision and radiation
  - $\pm$  chemotherapy
- This group remains potentially curable.

### Cervical lymph nodes

- Squamous or undifferentiated carcinoma in cervical lymph nodes should:
  - have an open biopsy, instead of FNA, if there is a possibility of lymphoma
  - be referred for full ENT examination under anaesthetic with:
    - direct laryngoscopy and nasopharyngoscopy
    - biopsy of the naso-, oro-, and hypopharynx
  - usually be treated as head and neck cancer with involved neck nodes.
- Radical loco-regional radiotherapy can result in a median survival of several years, especially if the nodes are high in the neck.
- $^{18}\text{F}$ FDG-PET-CT scanning should be offered to patients with cervical lymphadenopathy with no 1° tumour identified on ENT panendoscopy, provided the patient is a potential candidate for radical treatment.
- Thyroid cancer can be excluded by staining for TG.
- Supraclavicular lymph node metastases are usually associated with widespread malignancy and have a poor prognosis.

### Inguinal lymph nodes

- Careful examination of most patients with SCC in the inguinal nodes will demonstrate a detectable 1° site in the anorectal or genital region.
- Investigations should include:
  - digital rectal examination
  - proctoscopy
  - examination of the penis or vulva/vagina/cervix.



- Small anal cancers remain potentially curable, despite local lymph node involvement.
- Treatment often includes inguinal node dissection and combined-modality treatment with chemo-radiotherapy (as for locally advanced cervical cancer in women).
- 1° skin cancer should also be considered.

### Retroperitoneal or mediastinal lymph nodes in men

- Metastatic germ cell tumour should be considered, particularly:
  - in the presence of midline nodal disease
  - in young men
  - if serum HCG and AFP are elevated.
- Poorly differentiated adenocarcinoma with features of extragonadal germ cell malignancy is treated as non-seminomatous extragonadal germ cell malignancy.
- The treatment intent is curative.
- Intensive chemotherapy, e.g. with bleomycin, etoposide, and cisplatin, should be given and is often associated with an excellent response, even in the absence of histological confirmation of germ cell cancer or elevated serum tumour markers.

### Peritoneal carcinomatosis in women

- The differential diagnosis for adenocarcinoma with diffuse peritoneal disease includes:
  - ovarian cancer or other gynaecological 1° (55%)
  - 1° peritoneal malignancy
  - a GI 1°, especially if the tumour is mucin-secreting
  - breast cancer, particularly lobular.
- Serum CA125 and pelvic ultrasound may be useful but are not specific.
- Wherever possible, a tissue sample should be obtained for histology, rather than relying on cytology from ascitic fluid.
- Laparoscopy has an investigative role in selected cases to inspect intra-abdominal (especially gynaecological) organs and to take adequate biopsies.
- Debulking surgery should be considered if the disease is large-volume.
- Palliative chemotherapy can produce improvement in symptoms and temporary disease control. Malignant ascites in women, even without evidence of solid disease, is treated as advanced ovarian cancer, often with long-term survival.

## Investigation of metastases to other sites

### Intrapulmonary nodules

- Identified on CXR or CT thorax.
- Percutaneous biopsy if lesion sufficiently peripheral.
- Flexible bronchoscopy ±:
  - brushings or ideally biopsy for visible tumours
  - washings if tumour not visible
  - transbronchial needle aspiration of accessible lymph nodes.
- If unsuitable for percutaneous biopsy and bronchoscopic procedure negative, consider VATS.
- Sputum cytology—low yield. Reserve if bronchoscopy not appropriate.
- IHC—may help identify the 1°:
  - CK-7, lung/breast
  - CK-20, colorectal
  - thyroid transcription factor-1 (TTF-1), lung (surfactant apoprotein)
  - e.g. CK-7 and TTF-1 positive—phenotype 94% specific for lung.
- PET may be useful for staging, particularly if a lung 1° is suspected or if the 1° is not identified on CT.
- 1° commonly metastasizing to the lung, including head and neck SCC, breast, kidney, and large bowel.
- Resection of solitary metastases occasionally produces long-term survivors, e.g. from colorectal/renal 1°.

### Liver

- Present in 20–30% of patients with CUP.
- Usually identified on USS or CT scan.
- Completion of staging investigations is required (see → Initial management, p. 634) to determine the extent of the disease and any obvious 1°.
- Biopsy under image guidance, after correction of coagulation, is usually needed if treatment is to be considered. This guides the prognosis and allows the selection of therapy (core biopsy under image guidance gives more pathological information than FNA).
- Liver resection, often with preoperative chemotherapy, can sometimes be considered for solitary or limited hepatic metastases with a resectable colorectal 1°, in the absence of disease elsewhere—this group remains potentially curable and requires the involvement of an appropriate tertiary centre, usually via the local MDT.
- Common 1° sites include the GI tract and breast.
- If the patient appears disproportionately well for the volume of liver disease, consider atypical diagnoses, e.g. neuroendocrine tumours such as carcinoid.
- Otherwise, a group of patients with a poor prognosis.

## Bone

- Isotope bone scans:
  - caution must be exercised in the interpretation of isotope bone scans, and correlation with the plain radiographs should always be made
  - multiple 'hot spots', in the presence of a clear history of malignancy, almost certainly represent metastatic disease
  - certain non-neoplastic disorders, e.g. Paget's disease, may also demonstrate multifocal uptake
  - the differential diagnosis for a solitary 'hot spot' is broad
  - conversely, multiple myeloma and certain other aggressive tumours may present with a 'normal' bone scan
  - MRI may give more information.
- Discussion with the orthopaedic team is advised before the biopsy of a bone tumour of unknown aetiology. This is to prevent a poorly planned biopsy from jeopardizing the potential for a subsequent curative procedure or limb salvage surgery.
- If adenocarcinoma on biopsy, the 1° sites include:
  - commonly, the lung, prostate, and breast
  - less frequently, the kidney and thyroid
- Measure PSA in men with metastases predominantly affecting bone, particularly if the lesions are osteoblastic. Biopsy tissue may also stain for PSA. Even if PSA is not elevated, consider treating as advanced prostate carcinoma.
- A solitary bone metastasis occasionally warrants radical treatment such as high-dose radiotherapy or resection with endoprosthetic replacement, e.g. may permit long-term survival in the occasional patient with a solitary metastasis from RCC.

## Brain

- Metastases are the commonest form of intracranial tumour.
- The prognosis is often dictated by the extent of extracranial disease.
- Common potential 1° sites include:
  - lung
  - breast
  - melanoma.
- Leptomeningeal disease—also most commonly due to breast and lung cancers and melanoma, as well as large cell lymphomas and leukaemias. Up to 7% remain of unknown 1°, despite investigations.
- Patients with a solitary tumour in the brain should be referred to the appropriate MDT for consideration of radical local treatment.
- There is no evidence that any treatment improves survival in patients with multiple brain metastases of unknown 1°.

## Investigation of a pleural effusion

- Send fluid for cytology and biochemistry.
- Malignancy is more likely to be the cause if:
  - the patient is older
  - there are other risk factors, e.g. smoking, past history of asbestos exposure
  - the effusion is an exudate.
- If the fluid is a transudate, other diagnoses which can be considered include:
  - congestive cardiac failure
  - constrictive pericarditis
  - hypoalbuminaemia
  - nephrotic syndrome, etc.
- The differential diagnosis of an undiagnosed exudative effusion includes:
  - infection, e.g. bacterial pneumonia, tuberculosis
  - PE
  - inflammatory disorders, e.g. sarcoidosis, pancreatitis
  - metabolic causes, e.g. hypothyroidism.
- Malignant causes include:
  - metastatic carcinoma, e.g. breast or lung 1°
  - lymphoma
  - mesothelioma
  - leukaemia
  - chylothorax
  - Meigs' syndrome (ovarian fibroma, ascites, pleural effusion)
  - paraproteinaemia, e.g. multiple myeloma.
- CT of the chest—to assess for:
  - thoracic lymphadenopathy
  - pulmonary/pleural 1°
  - metastatic disease.
- Percutaneous pleural biopsy  $\pm$  image guidance—under local anaesthetic. This has a low sensitivity for malignant mesothelioma.
- Thoracoscopy—much more sensitive, particularly for malignant causes of effusions.
- Open pleural biopsy—occasionally necessary.
- Bronchoscopy—rarely helpful, unless the patient has imaging to suggest a parenchymal lesion or symptoms suggestive of intrapulmonary pathology, e.g. haemoptysis.



## Management of carcinoma of unknown primary

- The priority is to identify:
  - curable malignancies
  - clinical syndromes that respond well to specific therapies, e.g. some patients fall into the categories described earlier, and this guides management, e.g. adenocarcinoma in axillary lymph nodes in women is usually treated as stage II breast carcinoma (see ➔ Axillary lymph nodes in women, p. 636).
- After appropriate investigation, if the patient still has a diagnosis of CUP and does not fall into any of the subgroups described previously, then empiric treatment can be considered (see Fig. 26.1).
- The heterogeneity of this patient population makes interpretation of trial data difficult.
- With treatment, the median survival is generally <1y.
- Involvement of palliative care services is usually appropriate for all patients.

### Local therapy

- *Radiotherapy*—should be considered for symptomatic metastases, e.g. for painful bone metastases or for brain metastases.
- *Surgery*—only a single metastatic site of disease may be identified, despite full staging investigations. In most instances, other metastases become clinically evident within a short time. However, if no further disease is identified, then resection should be considered. This approach occasionally produces long disease-free intervals. This approach requires careful discussion with the patient and assessment at a multidisciplinary meeting.

### Systemic treatment

- Select appropriate patients who may benefit from chemotherapy with palliative intent, depending on:
  - the tumour characteristics (chemo-responsiveness)
  - the patient characteristics, including organ function, performance status, and QoL issues
  - discussion with the patient and often their family.
- There are relatively few randomized trials of chemotherapy in CUP.

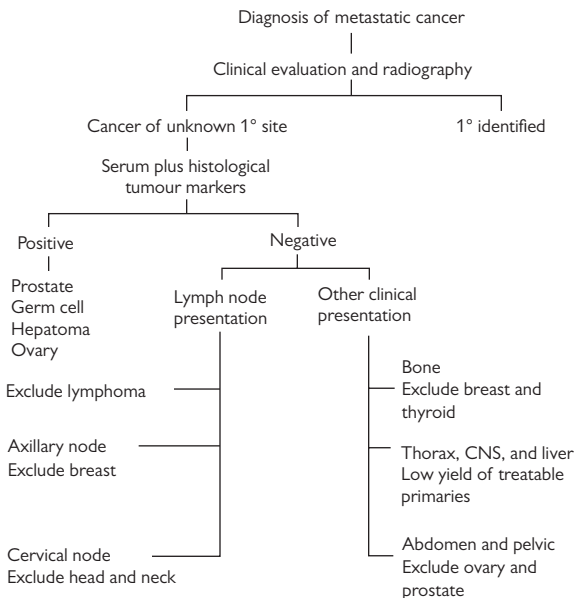

**Fig. 26.1** Identification of treatable cancer of unknown primary site.

Reproduced with permission from Cassidy J, Bissett D, Spence RAJ (1995) *Oxford Textbook of Oncology*, 1st edn. Oxford: Oxford University Press.

## Further reading

- Fizazi K, Greco FA, Pavlidis N, Pentheroudakis G; ESMO Guidelines Working Group (2011). Cancers of unknown primary site: ESMO Clinical Practice Guidelines for diagnosis, treatment and follow-up. *Ann Oncol* **22** (Suppl 6), vi64–8.
- National Institute for Health and Care Excellence (2010). *Metastatic malignant disease of unknown primary origin: diagnosis and management of metastatic malignant disease of unknown primary origin. Clinical guideline 104*. Available at: <http://www.nice.org.uk/guidance/cg104>.
- Pavlidis N, Petrakis D, Goulinopoulos V, Pentheroudakis G (2012). Long-term survivors among patients with cancer of unknown primary. *Crit Rev Oncol Hematol* **84**, 85–92.



# Paraneoplastic syndromes

Introduction 646

Endocrine paraneoplastic syndromes 648

Neurological paraneoplastic syndromes 650

Haematological paraneoplastic syndromes 652

Dermatological paraneoplastic syndromes 653

Other syndromes 653

Constitutional symptoms 654

Further reading 654

## Introduction

- These syndromes are caused by a cancer but are not due to direct local infiltration or metastatic spread.
- Occur in ~10% of cancer patients overall.
- Important to recognize, because they may be the presenting feature of an undiagnosed cancer.

Cancers commonly associated with paraneoplastic syndromes (PS):

- lung—SCLC and NSCLC
- pancreatic
- lymphoma—NHL and HL
- breast
- prostate
- ovary.

Although the mechanisms of PS are not fully understood, there appear to be two main causes:

- the inappropriate secretion of hormones and/or growth factors
- the production of anti-tumoural antibodies that cross-react with normal tissue antigens.



## Endocrine paraneoplastic syndromes

### Syndrome of inappropriate antidiuretic hormone

The commonest endocrine PS is due to the inappropriate secretion of antidiuretic hormone (ADH; arginine–vasopressin).

#### Cancer types

- SCLC (10% of patients), pancreatic, prostate, NHL, HL.

#### Presentation

- Often asymptomatic. CNS effects—fatigue, headaches; progressing to altered mental state, confusion, and seizures.

#### Diagnosis

- Exclude non-malignant causes, e.g. CNS disease (infection, trauma, vascular), pulmonary disease (infections, cystic lesions, asthma), drug-induced (thiazides, cytotoxics, narcotics); clinically euvolaemic; laboratory studies.

#### Management

- Fluid restriction (0.5–1.0L/day); demeclocycline (150–300mg, 8-hourly).

#### Laboratory criteria for diagnosis of syndrome of inappropriate antidiuretic hormone

- Hyponatraemia— $\text{Na}^+ < 130\text{mmol/L}$ .
- Normal serum albumin and glucose.
- Serum hypo-osmolality  $< 275\text{mmol/kg}$ .
- Urine osmolality  $>$  serum osmolality.
- Urinary  $\text{Na}^+ > 25\text{mmol/L}$ .
- Non-suppressed ADH.

### Cushing's syndrome

Inappropriate overproduction of ACTH precursors.

#### Cancer types

- SCLC, NSCLC, pancreatic, thymic, and carcinoid tumours.

#### Presentation

- Rapid onset, marked weakness 2° to proximal myopathy, hyperpigmentation, metabolic disturbances (e.g. hyperglycaemia, hypokalaemic alkalosis).

#### Diagnosis

- Clinical features, especially hyperpigmentation, myopathy; hypokalaemia and metabolic alkalosis; high 24h urinary cortisol, high plasma ACTH/precursors, no response to high-dose dexamethasone suppression or corticotrophin-releasing hormone stimulation.

#### Management

- Specific anti-tumour treatment. Decrease cortisol secretion either surgically (bilateral adrenalectomy) or medically (metyrapone, octreotide, ketoconazole).

## Hypercalcaemia

A common problem that, in many cases, is due to bony metastases. True paraneoplastic hypercalcaemia is due to tumour production of PTH-related protein (PTHrP). This syndrome is called humoral hypercalcaemia of malignancy (HHM).

### *Cancer types*

- NSCLC, head and neck, renal, other squamous cancers (rare in breast cancer where hypercalcaemia is usually due to bone metastases).

### *Presentation*

- Rapid onset of nausea, polyuria, polydipsia, dehydration, cardiac arrhythmias.

### *Diagnosis*

- Serum  $\text{Ca}^{2+}$   $>2.7\text{mmol/L}$ , serum chloride low, hypercalciuria, high urinary phosphate, low/undetectable plasma PTH.

### *Management*

- Saline hydration, IV pamidronate disodium (60–120mg).

## Hypocalcaemia

Associated with tumours with lytic bone metastases (breast, prostate, and lung); can also occur with calcitonin-secreting medullary carcinomas of the thyroid. Usually asymptomatic. Rarely develop tetany and neuromuscular irritability. Treatment with calcium infusions.

## Hypoglycaemia

Rarely caused by non-islet cell pancreatic tumours; often associated with mesenchymal tumours of the mediastinum and retroperitoneum and with hepatic cancers. The most likely cause is tumour production of the precursor to IGF-II. Treatment with glucose infusions, tumour debulking.

## Neurological paraneoplastic syndromes

- Common, occurring in up to 7% of cancer patients. The commonest syndromes are:
  - peripheral neuropathy (PN)
  - proximal myopathy.
- Thought to be 2° to autoimmune mechanisms via the production of anti-tumour antibodies.
- Treatment is based upon treatment of the cancer and decreasing antibody production by immune system suppression.
- Response to treatment is often poor (except for Lambert–Eaton myasthenic syndrome (LEMS)).

### Peripheral neuropathy

Asymptomatic PN is common; symptomatic PN less so. Usually occurs after a diagnosis of cancer has been made and caused by axonal degeneration or demyelination. Many types of PN, e.g. motor, sensory, autonomic, sensorimotor.

- *Cancer types*—SCLC, myeloma, Hodgkin's disease, breast, GI cancers
- *Presentation*—depends upon the type and site
- *Diagnosis*—exclude non-paraneoplastic causes; nerve conduction studies, nerve biopsy—look for inflammatory infiltrates; serum anti-Hu antibodies in some cases
- *Management*—corticosteroids; treat the underlying cancer.

### Encephalomyelopathies

Perivascular inflammation and selective neuronal degeneration at several levels of the nervous system. Can affect the limbic system, brainstem, and spinal cord.

- *Cancer types*—SCLC (75% of cases), breast, ovary, NHL.
- *Presentation*—slow, subacute onset; progressive.
- *Diagnosis*:
  - CSF—raised protein/IgG level, pleocytosis
  - serum—anti-Hu antibody
  - MRI.
- *Management*—anti-tumour therapy.

### Paraneoplastic cerebellar degeneration

- *Cancer types*—breast, SCLC, ovary, Hodgkin's disease.
- *Presentation*—rapid onset and progression; usually prior to cancer diagnosis; bilateral cerebellar signs; late diplopia and dementia.
- *Diagnosis*:
  - CT—cerebellar atrophy (late)
  - serum autoantibodies—anti-Yo, anti-Tr, and anti-Hu.
- *Management*—response to anti-tumour treatment, steroids, plasmapheresis.

### Cancer-associated retinopathy

- *Cancer types*—SCLC, breast, melanoma.
- *Presentation*—visual defects, i.e. blurred vision, episodic visual loss, impaired colour vision; leads to progressive painless visual loss; usually precedes cancer diagnosis.
- *Diagnosis*—loss of acuity; scotomata; abnormal electroretinogram; anti-retinal antibodies.
- *Management*—corticosteroids.

### Lambert–Eaton myasthenic syndrome

Disorder of the neuromuscular junction; reduced pre-synaptic calcium-dependent acetylcholine release. About 60% of patients with LEMS have an underlying cancer.

- *Cancer types*—SCLC (60–70%), breast, thymus, GI tract cancers.
- *Presentation*—proximal muscle weakness.
- *Diagnosis*—electromyography (EMG), normal conduction velocity with low-amplitude compound muscle action potentials that enhance to near normal following exercise.
- *Management*—cancer treatment, corticosteroids, plasma exchange (high response rate).

### Dermatomyositis/polymyositis

Inflammatory myopathies, often present prior to cancer diagnosis.

- *Cancer types*—NSCLC, SCLC, breast, ovary, GI tract cancers.
- *Presentation*—proximal myopathy, skin changes, other systemic features; cardiopulmonary conditions, arthralgias, retinopathy.
- *Diagnosis*:
  - serum—high creatine kinase (CK), LDH, aldolase
  - muscle biopsy—myositis
  - EMG—fibrillation, insertion irritability, short polyphasic motor units.
- *Management*—search for, and treat, the tumour; corticosteroids, azathioprine.

## Haematological paraneoplastic syndromes

### Red cell disorders

#### *Erythrocytosis*

Common, often 2° to increased EPO production, e.g. RCC, hepatoma. Treat with venesection, if required.

#### *Haemolytic anaemia*

- Autoimmune—2° to lymphoproliferative disorders (treatment with corticosteroids).
- Micro-angiopathic—2° to vascular tumours, acute pro-myelocytic leukaemia, or widespread metastatic adenocarcinoma. Treat the tumour; replace coagulation factors; IV heparin.

#### *Red cell aplasia*

Seen in thymoma, CLL; rare in solid tumours.

### White cell disorders

- Autoimmune neutropenia (rare).
- Granulocytosis—2° to haemopoietic growth factor-secreting tumours (e.g. squamous cell cancers of the lung, thyroid).
- Eosinophilia—in patients with HL.

### Platelet disorders

- Thrombocytosis— $>450 \times 10^9/L$  is common and usually asymptomatic; in some cases, may be 2° to IL-6 production.
- Idiopathic thrombocytopenia—associated with leukaemias and lymphomas.

### Coagulopathy

- Minor abnormalities of fibrin and fibrinogen degradation products are common.
- Overt DIC is rare and is associated with acute myelocytic leukaemia and adenocarcinomas.
- Diagnosed by a triad of thrombocytopenia, abnormal prothrombin time, and hypofibrinoginaemia.
- Management is controversial.



## Dermatological paraneoplastic syndromes

### Pruritus

Common; characteristic of HL, leukaemias, CNS tumours, NHL.

### Pigmentation

- *Acanthosis nigricans*—itchy brown hyperkeratotic plaques, mainly in flexures; may precede cancers by many years; associated with GI tract tumours, e.g. gastric adenocarcinoma.
- *Vitiligo*—patchy depigmentation, especially the face, neck, and hands; associated with malignant melanoma; possibly due to anti-melanoma immune response.

### Erythematous

- *Necrolytic migratory erythema*—islet cell tumour.
- *Exfoliative dermatitis*—cutaneous T-cell lymphoma.

### Bullous

- *Pemphigus*—characteristic bullous lesions on the skin and mucous membranes; associated with lymphoma, KS, thymic tumours.
- *Dermatitis herpetiformis*—chronic, intensely itchy vesicles over the elbows, knees, and lower back; precede the tumour by many years; associated with lymphomas, e.g. NHL of the small intestine.

## Other syndromes

### Hypertrophic osteoarthropathy

Characterized by finger clubbing, periosteal new bone formation, and arthropathy.

- *Cancer types*—lung cancer, especially NSCLC.
- *Presentation*—painful, swollen joints.
- *Diagnosis*:
  - clinical—X-ray showing periosteal shadowing
  - bone scan—increased uptake.
- *Management*—anti-tumour therapy, NSAIDs, corticosteroids, radiation.

## Constitutional symptoms

### Fever (pyrexia of unexplained origin, PUO)

Can be the presenting feature of lymphoma, hepatoma, RCC; mediated by IL-1; treat with NSAIDs, corticosteroids; exclude other causes.

### Cachexia

Very common; >10% loss of body weight is associated with a poor prognosis; due to complex multifactorial metabolic derangements; treat with enteral caloric supplements and appetite stimulants, e.g. corticosteroids, megestrol acetate.

## Further reading

- John WJ, Patchell RA, Foon KA (1994). Paraneoplastic syndromes. In: DeVita VT, Hellman S, Rosenberg SA, eds. *Cancer: principles and practice of oncology*, 5th edn. Philadelphia: Lippincott-Raven, pp. 2397–422.
- MacCaulay VM, Smith IE (1995). Paraneoplastic syndromes. In: Peckham M, Pinedo H, Veronesi U, eds. *Oxford textbook of oncology*. Oxford: Oxford University Press, pp. 2228–53.
- Multiple authors (1997). A series of articles on paraneoplastic syndromes in *Semin Oncol* 24, 265–381.

# AIDS-related malignancies

Introduction 656

Effects of antiretroviral therapy 657

Kaposi's sarcoma 658

Systemic non-Hodgkin's lymphoma 662

Primary central nervous system lymphoma 664

Cervical cancer in HIV-positive females 666

Non-AIDS-defining malignancies 668

Further reading 670

## Introduction

HIV represents the worst pandemic of the last quarter of a century.

- The pandemic has reached nearly all populations worldwide.
- In 2011, it was estimated that:
  - ~34 million people were living with HIV/AIDS, including 2.5 million children
  - 1.7 million people died due to AIDS during that year
  - there was wide variation in the worldwide prevalence of HIV infection (see ➔ Further reading, p. 670), e.g.:
    - 0.1% East Asia
    - 7% sub-Saharan Africa
    - >35% in certain countries, e.g. Botswana.
- The rate of new cases in some countries is stabilizing, but, in others, e.g. parts of Eastern Europe, the incidence continues to increase.
- The availability of generic medication, intensive input from several global aid programmes, and policy changes within the worst affected countries is steadily increasing access to antiretroviral therapy (ART). It is estimated that a third of people with HIV in developing countries now have access to treatment.

Malignant disease is observed in 25–40% of all HIV-infected patients at some stage in their illness and may be causative in almost one-third of HIV-related deaths.

Currently, four malignancies define the onset of AIDS:

- KS
- intermediate and high-grade NHL of B-cell or unknown immunological phenotype
- PCNSL (in patients aged >60y, a positive HIV serology is required to define the onset of AIDS)
- invasive cervical cancer in HIV-positive ♀.

Other tumours have an increased incidence in HIV-positive individuals, e.g. anal cancer, Hodgkin's disease, but are not AIDS-defining.

The management of the patient with an AIDS-related malignancy requires a multidisciplinary approach, with consideration of:

- the cancer
- the underlying immune deficiency
- any coexistent complex psychological and social issues.

## Effects of antiretroviral therapy

- The evolution of ART made it possible to achieve near-complete suppression of the viral load and to maintain CD4 lymphocyte counts.
- This increasing efficacy of ART is changing the spectrum of cancers observed in patients with HIV in the developed world.
- Observations include:
  - ↓ incidence of opportunistic infections
  - ↓ incidence of KS
  - ↓ incidence of NHL
  - ↑ incidence of non-AIDS-defining cancers
  - ↑ proportion of HIV-related deaths attributable to cancer. Pre-ART, this figure was 10%. Currently, 25–30% of deaths in patients with HIV are due to malignancy. Possible explanations for this include:
    - a reduction in competing causes of deaths
    - an ageing population
    - the effects of chronic immunosuppression
    - co-infection with other oncogenic viruses, e.g. EBV, HPC, HBV, human herpesvirus-8 (HHV-8).

## Kaposi's sarcoma

- Incurable multifocal soft tissue sarcoma of vascular origin, with a highly variable clinical course.
- Remains the commonest malignancy seen in patients with HIV infection, despite its falling incidence.
- Cutaneous involvement is characteristic, and disease progression may be slow. However, it can behave aggressively, affecting visceral sites and causing significant morbidity and mortality.

### Epidemiology and aetiology

Four clinical settings recognized:

- *classical form*—often indolent. Affects predominantly the extremities of older men from the Mediterranean, Middle East, or Eastern Europe
- *endemic African variant*—pre-dating HIV. Also ♂ predominance. May be indolent or aggressive
- *iatrogenic*—seen in patients receiving immunosuppressive therapy, e.g. in organ transplant recipients, typically 1–2y after transplant. The tumour may regress when this treatment is reduced. Again, ♂ predominance
- *epidemic AIDS-related form*—now the commonest form in the developing world:
  - in the West, principally a disease of men who have sex with men (MSM). Much less common in other groups of patients with HIV
  - associated with infection with HHV-8. Infection precedes, and is predictive of, the development of KS, although its precise role in the pathogenesis is not understood—increasing anti-HHV-8 antibody titres and the absence of neutralizing antibodies have both been associated with a greater risk of disease. Transmission is likely to be both sexual and non-sexual. DNA from HHV-8 has been identified in KS lesions, semen, blood, and bronchial washings from affected patients
  - the incidence of KS has declined markedly with the development of ART. This decline cannot be attributed to a fall in the incidence of HHV-8, which has remained essentially stable
  - Despite a falling incidence, the morbidity and mortality ascribed to KS has increased. Visceral KS accounts for the death of one in four HIV-positive MSM.

### Presentation

May be precipitated/exacerbated by exogenous steroids. Lesions may regress on withdrawal of steroids.

#### Cutaneous

- Multiple non-painful red-purple lesions.
- Flat → plaques → nodules with oedema. Up to several cm in diameter.
- Typically affecting the upper body, face, oral mucosa, genitalia, and legs.

### Systemic

- Involvement of the organs is usually a later manifestation of KS and is rarely a presenting feature.
- *Pulmonary*—cough, breathlessness, chest pain, incidental finding on CXR (effusion, infiltration, lymphadenopathy), occasionally haemoptysis
- *GI* (40% at diagnosis)—weight loss, pain, diarrhoea, obstruction, bleeding, lesions visible on the palate/gums (>30% of patients with KS have oral involvement)
- *Lymphoedema*.

### Investigations

- Skin biopsy to confirm the diagnosis.
- CXR  $\pm$  bronchoscopy if pulmonary KS suspected.
- FOB test may be positive with GI KS, but a negative result is unhelpful.
- Endoscopy if GI KS suspected.
- CD4 count and viral load (necessary for accurate staging and appropriate treatment selection).

### Pathology

- Key histological features characterizing all forms of KS are:
  - inflammatory infiltrate
  - angiogenesis
  - proliferation of spindle cells.
- A diagnostic feature is the intradermal proliferation of abnormal vacuolar structures, lined with large, spindle-shaped endothelial cells.
- Also:
  - micro-haemorrhages
  - haemosiderin deposition.

### Staging

The AIDS Clinical Trials Group (ACTG) has developed a staging classification, designed to assist with prognosis (see Table 28.1).

**Table 28.1** ACTG guidelines

	Good prognosis—all of:	Poor prognosis—any of:
Tumour	Skin only $\pm$ lymph nodes and/or minimal oral disease	Oedema/ulceration, extensive oral disease, visceral KS
Immunological	CD4 cell count >200/ microliter	CD4 cell count <200/ microlitre
Symptoms	Nil, Karnofsky >70	Opportunistic infection or thrush, B symptoms*, Karnofsky <70, other HIV-related illness

\* B symptoms are recurrent sweats/fevers, persistent diarrhoea, and involuntary weight loss.

**Management**

Treatment is palliative in intent, with the 1° goal being to stabilize the tumour growth, whilst maintaining the QoL.

*Local therapy for local control and cosmesis*

- *Cryotherapy and laser*—especially if lesions are  $\leq 1$ cm.
- *Topical agents*—e.g. with 9-cis retinoic acid (alitretinoin). May produce local disease response after 4–12wk of treatment. Response rates of 30–40%. The advantages are that this is a patient-administered therapy with low toxicity; the main side effect is local irritation.
- *Intralesional chemotherapy*—e.g. with vinblastine. Injection into the KS lesion can produce short-term regression in ~75% of cases. The mean duration of palliation is typically 3–4mo. Most effective for smaller lesions.
- *Radiotherapy*—may be the preferred treatment for lesions that are too extensive for intralesional chemotherapy. A response rate equal to intralesional chemotherapy can be achieved with single-fraction doses of 8Gy. Can be repeated if there is recurrence or insufficient regression. Palatal lesions can also be irradiated, using iridium wire moulds.

*Systemic therapy*

If cutaneous disease is widespread, local treatment has failed, or there is extensive symptomatic oedema or visceral disease.

*Combined antiretroviral therapy*

- Recommended for almost all patients with AIDS-related KS.
- May be the only treatment needed. ~60% of patients respond to immune restoration if treated with ART alone.
- Lesions may fully or partially regress, and there may be the disappearance of baseline HHV-8 viraemia.
- Response rates may be greater if ART is combined with the appropriate chemotherapy.

*Chemotherapy*

- Consider if:
  - the disease is extensive
  - the progression appears to be rapid
  - there are significant symptoms unresponsive to ART.
- Liposomal anthracyclines (e.g. pegylated liposomal doxorubicin, Caelyx®) are the first-line choice.
- Response rates of 30–60% have been observed and may be greater if given in combination with ART.
- Treatment is usually well tolerated, and cardiotoxicity with the new liposomal preparations is less than for conventional anthracyclines.
- Paclitaxel can be considered as second-line treatment in selected patients.



### Biological therapies

- *Imatinib*—orally active TKI which inhibits both c-kit receptors and the PDGFRs. Activation of these receptors is understood to be important for the proliferation of KS lesions. Only studied in small early-phase trials so far (when response rates of up to 50% have been reported).
- *Bevacizumab*—mAb targeting the VEGF receptor which is believed to have a role in the growth of KS. A recent encouraging, but small, phase II trial (17 patients) reported disease response in 31% and disease stabilization in a further 56%.
- *Immunotherapy*:
  - interferon alfa—most effective if the disease is non-visceral and the CD4 count is >200/microlitre. Response rates of 20–40% have been observed. Potential toxicity includes 'flu-like symptoms', marrow suppression, and depression
  - IL-12—disease response reported when used in small non-randomized trials, either as single-agent treatment or in combination with standard chemotherapy.

### Supportive care

- Camouflage with cosmetics.
- Psychosocial support.
- Palliation of symptoms.

## Systemic non-Hodgkin's lymphoma

### Epidemiology and aetiology

- Second commonest malignancy to affect those with AIDS, despite a falling incidence since the widespread use of ART. Almost half of patients will previously have had an AIDS-defining illness.
- The risk of a person with HIV developing lymphoma is 60–160 times greater than in the seronegative population.
- The incidence of systemic NHL increases with worsening immunosuppression. NHL also has a higher incidence in individuals who are immunocompromised for other reasons.
- Close association between the development of NHL in AIDS and infection with EBV. EBV proteins can be demonstrated in  $\geq 50\%$  of lymphomas, particularly immunoblastic and large cell lymphomas. It is thought that the proliferation of EBV-infected cells in the immune-deficient host may proceed unchecked.
- Oncogenic mutations have also been identified, e.g. in the *p53* tumour suppressor gene and *c-MYC* gene.

### Presentation

- Typically seen in advanced HIV infection ( $CD4 \leq 100$ /microlitre).
- Frequently involves extra-nodal sites— $\sim 80\%$  have stage IV disease at presentation, e.g. involving the GI tract, bone marrow, CNS, including lymphomatous meningitis, liver, or recurrent effusions (1° effusion lymphoma is a variant of NHL).
- Constitutional 'B' symptoms are common (see  Hodgkin's lymphoma, p. 574).
- Differential diagnoses include tuberculosis and CMV.

### Pathology

- $\sim 80\%$  of AIDS-associated NHL is high grade.
- $\geq 90\%$  are diffuse large B-cell (immunoblastic subtype) or Burkitt's-like lymphoma.
- Not all lymphomas in the immunocompromised patient are monoclonal. Some tumours may comprise polyclonal cell populations that demonstrate metastatic potential.

### Investigations and staging

- Bloods, including LDH.
- CXR.
- CT of the head, abdomen, and pelvis
- Consider PET—may assist in accurate staging.
- Lymph node biopsy (ideally not FNA) and bone marrow biopsy.
- Lumbar puncture and CSF examination, even if asymptomatic.

### Poor prognostic factors

- Prior AIDS-defining diagnosis or  $CD4$  count  $< 100$ /microlitre.
- Karnofsky performance score  $< 70$ .
- Age  $> 35$ y.
- Extra-nodal disease, including bone marrow involvement.
- $\uparrow$  LDH.
- Immunoblastic subtype.

## Management

- Optimal management should be coordinated in a centre with specialist expertise in AIDS-associated lymphomas.
- Concomitant ART reduces the incidence of opportunistic infections and improves survival.
- Patients also generally receive prophylaxis against *Pneumocystis jiroveci* pneumonia (PCP).
- Potentially curative local treatments can be considered for patients presenting with stage I or II NHL (see Chapter 24).
- The vast majority of patients with AIDS-associated NHL present with stage IV disease and require systemic therapy.
- Treatment for advanced disease is with combination chemotherapy, e.g. CHOP (cyclophosphamide, doxorubicin, vincristine, and prednisolone), given on a 3-weekly schedule, is a commonly used regime, although many other combinations have been tried.
- Baseline immunodeficiency and reduced bone marrow reserve means more intensive chemotherapy regimens tend to be poorly tolerated.
- Leptomeningeal involvement requires intrathecal chemotherapy, usually with MTX and cytarabine. Intrathecal prophylaxis remains controversial but can be considered in those at high risk of meningeal involvement (e.g. patients with BL, paraspinal or paranasal disease, bone marrow infiltration, or EBV detected in their CSF).
- Response rates to treatment and TTP are less good in patients with AIDS than in seronegative patients treated for lymphomas of similar histology. However, the routine use of ART plus combination chemotherapy has improved the outlook a little; the 2–3y survival is now 40–60%, with death usually due either to recurrent lymphoma or opportunistic infection. Those who achieve a complete response with chemotherapy have a survival benefit ranging from 6 to 20mo, with a small percentage of long-term survivors.
- Rituximab—a mAb used in the standard treatment of NHL in the general (non-immunosuppressed) population. However, its role in AIDS-associated NHL is controversial, with no phase III data yet supporting its use and evidence to suggest it may decrease CD4 counts, increase the viral load, and increase infectious complications. Hence, its use must be carefully monitored.

## Primary central nervous system lymphoma

### Epidemiology and aetiology

- Affects at least 2–6% of HIV-positive individuals (autopsy series suggest the incidence may be greater).
- Accounts for 15% of NHLs in HIV-infected patients (as opposed to 1% of NHLs seen in the HIV-negative population).
- Usually a late manifestation of AIDS ( $CD4 \leq 50/\text{microlitre}$ ), and patients often have other serious opportunistic infections.
- Falling incidence in the developed world since the introduction of HAART.

### Presenting symptoms

- Focal, e.g. hemiparesis, aphasia, focal seizures, deafness, cranial nerve palsies.
- Non-focal, e.g. confusion, lethargy, headaches.
- Constitutional 'B' symptoms identified in ~80% of cases.

### Pathology

- Diffuse B-cell lymphoma is the most common subtype.
- The histology is similar to that of AIDS-related NHL, except that almost all cases are associated with EBV. This is very different to PCNSL in seronegative patients, which is not associated with EBV.
- Disease limited to the CNS.

### Investigations

- MRI is the investigation of choice. The typical appearance is of a well-defined enhancing focal lesion, which may be indistinguishable from cerebral toxoplasmosis.
- CSF cytology  $\pm$  amplification of EBV DNA in CSF sample.
- Toxoplasmosis serological testing.
- SPECT scanning, e.g. using thallium-201, may have a role as a means of non-invasively differentiating between PCNSL and toxoplasmosis.
- Consider slit-lamp examination to assess for ocular involvement (reported in up to 15% of patients).
- Stereotactic brain biopsy is occasionally necessary, particularly if there has been no response to antitoxoplasma therapy.

### Management

- Empirical treatment with antitoxoplasma therapy, pending the results of other investigations.
- Delay the use of steroids, until after investigations have been completed, if at all possible. Exogenous corticosteroids may reduce the tumour size and provide symptomatic benefit. They can also reduce the radiological enhancement after contrast injection and the diagnostic yield at biopsy.
- Treatment should be combined with appropriate HAART. There is evidence to show that an increase in  $CD4$  count, combined with tumour-specific therapy, increases survival. It may also affect the disease distribution, e.g. reduction in leptomeningeal involvement. Unfortunately, MDR is common in the group of patients whose immunosuppression puts them at greatest risk of developing PCNSL.

- Standard first-line treatment for AIDS-associated PCNSL is whole-brain radiotherapy, in combination with corticosteroids. Complete response rates as high as 50% have been reported.
- Intrathecal chemotherapy is occasionally used. There is little evidence to support the use of systemic chemotherapy.
- Entry into clinical trials should be offered, wherever possible.
- Untreated, typical survival is 1–2mo. With treatment, the median survival from diagnosis remains just 2–4mo. This is largely due to the context of severe immunocompromise, in which PCNSL typically develops—death is usually due to opportunistic infections.
- A good performance status at diagnosis is associated with longer survival—palliation for up to 18mo may occasionally be possible.

## **Cervical cancer in HIV-positive females**

- Moderate/severe cervical dysplasia is classed as an early symptomatic HIV condition in seropositive ♀.
- The prevalence of CIN is up to 40% in HIV-infected women.
- All HIV-positive women should be encouraged to participate in screening programmes, wherever possible. It is advisable to screen patients frequently. An initial cervical smear test and colposcopy at the time of diagnosis with HIV is recommended. The cervical smear should be repeated after 6mo, and subsequently it is recommended annually.
- Effective ART is often associated with regression of CIN (>70% of low-grade lesions), particularly in women who are less immunocompromised when the lesion is diagnosed.
- HIV-infected women with stable CD4 levels and low viral loads can be managed in the same way as the seronegative population (see Chapter 20).
- Cervical cancer in seropositive ♀ is an AIDS-defining diagnosis. Its increased prevalence may be because both the HIV virus and the oncogenic HPV are sexually transmissible. The incidence of all HPV-associated cancers is increased in AIDS. The incidence of cervical cancer is also inversely related to the CD4 count.
- In most women (almost 30%), invasive cervical cancer is the initial AIDS-defining diagnosis.
- A potential major clinical issue in sub-Saharan Africa where there is no routine access to screening. However, at present (with limited availability of ART), the commonest cause of death in these regions remains opportunistic infections.



## Non-AIDS-defining malignancies

### Hodgkin's disease

- The incidence of Hodgkin's disease in HIV-positive patients is 5–9 times greater than in the general population.
- The commonest histological variant in patients with HIV is the mixed cellularity subtype (compared with nodular sclerosis in non-HIV-infected patients with Hodgkin's disease).
- The development of Hodgkin's disease is associated with worsening immunosuppression, as with the AIDS-defining malignancies.
- More commonly observed in patients where the transmission of HIV has been by IV drug use.
- Strong association with EBV infection.
- Often advanced at presentation, with bone marrow involvement present in ~50% and widely disseminated extra-nodal disease in >75%.
- Combination chemotherapy should be combined with appropriate HAART. CR following therapy is possible. However, the median survival is only 12–18mo, with death due to relapse or opportunistic infections.

### Anal cancer

- Anal cancer is independently associated with both HIV and HPV. MSM are a group at particular risk. The incidence of anal cancer in HIV-positive MSM is ~ twice that seen in seronegative MSM. There is often a preceding history of anal warts.
- Treatment of anal dysplasia in HIV-infected individuals is controversial. Low-grade lesions can be followed clinically by serial anoscopy and biopsy, whilst high-grade lesions, when the immune function is preserved, can be treated by excision and laser ablation (if dysplasia is limited).
- Anal intraepithelial neoplasia (AIN) developing at the epithelial transformation zone is the pre-invasive condition, believed to progress to anal cancer (analogous to CIN in cervical cancer). However, the association between the risk of AIN and the CD4 count remains unclear. Effective ART does not correlate with regression of AIN (unlike CIN).
- Anal cancer may be asymptomatic. Alternatively, presentation with tenesmus, bleeding, pruritus, or pain may occur.
- Treatment is with HAART and chemo-radiotherapy.

### Other solid malignancies

- The increasingly widespread use of ART has reduced the incidence of the AIDS-defining cancers. The impact of ART on other cancers within the seropositive population is less clear.
- Evidence suggests an increased incidence of other solid tumours in patients with concomitant HIV infection. Whilst AIDS-defining malignancies are generally associated with advanced immunosuppression, it is emerging that even patients with controlled HIV are at increased risk of other incurable solid malignancies.



- Of these, the leading cause of mortality in the HIV-infected population is lung cancer:
  - ~30% of all cancer-related deaths
  - ~10% of all non-HIV-related deaths
  - onset 2–3 decades earlier than in the non-HIV population
  - average cigarette exposure lower than in the non-HIV population.
- Other solid cancers seen at greater frequency in patients with HIV include:
  - skin cancers, particularly BCC
  - testicular tumours
  - squamous cell head and neck cancers.

## Further reading

- Joint United Nations Programme on HIV/AIDS (UNAIDS) and World Health Organization (2012). *UNAIDS report on the global AIDS epidemic (2012)*. Available at: [http://www.unaids.org/en/media/unaids/contentassets/documents/epidemiology/2012/gr2012/20121120\\_UNAIDS\\_Global\\_Report\\_2012\\_with\\_annexes\\_en.pdf](http://www.unaids.org/en/media/unaids/contentassets/documents/epidemiology/2012/gr2012/20121120_UNAIDS_Global_Report_2012_with_annexes_en.pdf).
- Kaplan LD (2012). HIV-associated lymphoma. *Best Pract Res Clin Haematol* **25**, 101–17.
- Martis N, Mounier N (2012). Hodgkin lymphoma in patients with HIV infection: a review. *Curr Hematol Malig Rep* **7**, 228–34.
- Radu O, Pantanowitz L (2013). Kaposi sarcoma. *Arch Pathol Lab* **137**, 289–94.
- Winstone TA, Man SF, Hull M, Montaner JS, Sin DD (2013). Epidemic of lung cancer in patients with HIV infection. *Chest* **143**, 305–14.

# Childhood cancers presenting in adults

Introduction 672

Embryonal tumours 674

Soft tissue sarcomas 676

Further reading 677

## Introduction

Uncommonly, malignant tumours of pathology identical to childhood cancers occur in adults, usually aged 20–40y, and these present a variety of particular challenges:

- often present with advanced disease
- the pathological diagnosis may be difficult and may require expert central review by a paediatric pathologist and confirmatory cytogenetics
- scant evidence base to direct management in adults, no randomized trials, and few published historical series, often reflecting changes in management over several decades
- usually present through adult MDTs who may lack the experience and expertise in the treatment of these tumours, no designated national centres
- lack of research/novel therapy development because of their rarity and Cinderella status with the pharmaceutical industry.

In general, management will be broadly based on current practice in paediatric patients, but this must be modified to account for:

- frequently aggressive tumour pathology and natural history, with relatively poor prognosis in adult patients, compared with children
- age-related intolerance to intensive therapies:
  - these patients may best be treated with G-CSF and/or broad-spectrum antibiotics as 1° prophylaxis against febrile neutropenia during chemotherapy
  - cumulative myelosuppression and non-haematological toxicities (neuro- and cardiotoxicity) commonly limit the number of cycles of chemotherapy that can be safely delivered
- relative safety and breadth of experience with radiation therapy in adults, compared with children, at most tumour sites:
  - in particular, fewer concerns with regard to late effects of treatment on growth, fertility, and the risk of 2° malignancy.

This chapter will cover the solid tumours of childhood that can occur in adults; for haematological malignancies, see Chapter 24.



## Embryonal tumours

### Medulloblastoma

- ~2% of adult CNS tumours.
- Median age 30y, very occasionally aged >60y.
- Usually present with disease in the lateral cerebellar hemisphere (the vermis is the usual site in children).
- Differentiate from metastasis and glioma.
- The majority are treated by surgical resection, followed by craniospinal radiotherapy:
  - 35Gy to the whole brain and spine
  - boost to 54Gy to the posterior fossa.
- Chemotherapy reserved for metastatic disease or recurrence.
- Late relapse in the posterior fossa is a common feature.
- 10y survival ~50%:
  - prognosis worse with invasion of the brainstem or fourth ventricle.

Radiation therapy should be planned and delivered by a team experienced in the delivery of craniospinal radiotherapy.

### Retinoblastoma

- Very rare after the age of 5y.
- Median age in adults 38y (range 20–74y).
- Present with loss of vision.
- Visible white tumour mass arising from the choroid.
- Differential diagnosis—lymphoma, amelanotic melanoma, metastatic carcinoma, benign retinocytoma, and inflammatory conditions.
- Should be managed in national specialist centres for ocular oncology (in the UK, Moorfield and Barts or Liverpool).
- Biopsy can be performed prior to definitive treatment.
- Enucleation is often the most appropriate treatment.

### Neuroblastoma

- Arise in the adrenal gland or elsewhere in the sympathetic nervous system.
- Differentiate from adrenal adenoma, adrenal metastasis, adenocarcinoma, and pheochromocytoma.
- Surgical resection only for localized disease.
- Adjuvant chemotherapy and radiotherapy indicated for:
  - stages II–IV
  - high-risk pathology, i.e. undifferentiated tumours
  - amplification of the *MYCN* oncogene.
- Pathology and genetic analysis can be carried out on image-guided core biopsy.
- Recently agreed image-defined risk factors can be used in patients being considered for neoadjuvant therapy:
  - ipsilateral tumour extension within two body compartments (neck–chest, chest–abdomen, abdomen–pelvis)
  - neck tumours encasing major vessels, extending to the skull base, or compressing the trachea

- cervico-thoracic junction tumours encasing the brachial plexus or major vessels
- thoracic tumours encasing major arteries, compressing major airway, or invading the rib/spine
- abdominal or pelvic tumours infiltrating adjacent organs, major vessels, the sciatic nerve
- intra-spinal tumour.
- Metastatic disease has a poor prognosis with no MS stage (spread of disease confined to the skin, liver, bone marrow, with relatively good prognosis) in patients >18mo.
- Chemotherapy regimens include high-dose cyclophosphamide or ifosfamide, doxorubicin, cisplatin, and etoposide.
- EBRT can be used with considerably greater freedom to improve local control than in young children:
  - therapy dose of radiolabelled MIBG may be useful in the palliation of advanced disease
  - metastatic disease may also respond well to short courses of palliative radiotherapy by external beam.

The staging system for neuroblastoma is shown in Table 29.1.

### Wilms' tumour

- Median age 26y (range 16–73y).
- The prognosis depends on the stage and pathology.
- Pathological diagnosis of poor prognosis (WT with anaplasia) can be difficult to differentiate from sarcomatoid carcinoma: need for central paediatric review of the pathology.
- Worse prognosis stage for stage, compared with children, particularly with unfavourable histology.
- Radiotherapy of 40–50Gy to the renal bed after incomplete resection.
- Adjuvant chemotherapy, as per paediatric protocols, with some provisos: adults tolerate weekly vincristine poorly, rapidly developing peripheral and autonomic neuropathy
- first-line therapy vincristine, actinomycin, doxorubicin, ± cyclophosphamide, carboplatin, etoposide.
- Reported overall 5y survival >80%.
- Occasionally, late lung 2° have been reported over 20y after the 1° resection.

**Table 29.1** Neuroblastoma—international staging system (adults)

Stage	Description
1	Localized tumour with complete gross excision, including any involved lymph nodes
2A	Localized tumour with incomplete gross excision, node-negative
2B	Localized tumour with residual ipsilateral involved nodes
3	Unresectable unilateral tumour infiltrating across the midline or with contralateral lymph node involvement
4	Disseminated disease (distant lymph nodes, bone, bone marrow, liver, skin, etc.)

## Soft tissue sarcomas

### Rhabdomyosarcoma

Sarcomas arising from muscle are relatively rare in adults, and the majority bear little resemblance to the embryonal rhabdomyosarcoma of childhood, in terms of the natural history and behaviour.

- Only comprises 2% of soft tissue sarcomas >16y.
- Median age of 45y, with bimodal distribution (one peak in the late teens, the other in the 60s).
- The majority are of pleomorphic pathology:
  - then, in order, embryonal, followed by alveolar.
- Pathological diagnosis may be difficult and need central review:
  - cytogenetics can be helpful (1:13 and 2:13 translocations in alveolar rhabdomyosarcoma).
- One in three presents with metastatic disease, most often blood-borne to the lung.
- One in five has lymph node spread, relatively unusual in sarcomas.
- Truncal and limb sites predominate but can arise in the head and neck/genitourinary tract.
- Chemotherapy recommended for all patients, if fit, e.g. doxorubicin–ifosfamide-based regimens.
- Response rate of up to 80%, with complete responses in 30–40%.
- Best outcome with tumours <5 cm, good response to chemotherapy, and embryonal pathology (see Table 29.2).
- Localized tumours have a 30–50% local recurrence rate.
- Overall 5y survival only 35%.
- Because this tumour is chemosensitive, surgery is used for biopsy and excision, where practical, without causing extensive morbidity. Repeat excision of limb and trunk tumours and debulking retroperitoneal tumours may provide some survival advantage.

**Table 29.2** Rhabdomyosarcoma—pathology and behaviour

Pathological type	%	Site	Response to chemotherapy
Pleomorphic	36	Limb, trunk	Sensitive
Alveolar	23	Limb, trunk	Resistant
Embryonal	28	Head and neck, trunk	Highly sensitive
Other	13		



## Further reading

- Helman LJ, Malkin D (2008). Cancers of childhood. In: DeVita VT, Lawrence TS, Senberg SA, eds. *Cancer: principles and practice of oncology*. Philadelphia: Lippincott, Williams and Wilkins, pp. 2033–83.
- Izawa JI, Al-Omar M, Winquist E, et al. (2008). Prognostic variables in adult Wilms tumour. *Can J Surg* 51, 252–6.
- Padovani L, Sunyach MP, Perol D, et al. (2007). Common strategy for adult and pediatric medulloblastoma: a multicenter series of 253 adults. *Int J Radiat Oncol Biol Phys* 68, 433–40.
- Parambil J, Aughenbaugh GL, Pereira JC (2005). Solitary pulmonary metastasis presenting 20 years after primary resection of Wilms tumour. *Mayo Clin Proc* 80, 1514–16.
- Simon JH, Paulino AC, Ritchie JM, Mayr NA, Buatti JM (2003). Presentation, prognostic factors and patterns of failure in adult rhabdomyosarcoma. *Sarcoma* 7, 1–7.



## Part 5

# Emergencies in oncology

30	Spinal cord compression and bone marrow suppression	681
31	Overview of acute oncology	691
32	Superior vena cava obstruction and raised intracranial pressure	695
33	Airway obstruction	703
34	Thromboembolic and cardiac emergencies	711
35	Obstruction	719
36	Biochemical crises	731
37	Complications of long-term central venous lines and chemotherapy extravasation	743



# Spinal cord compression and bone marrow suppression

Spinal cord compression 682

Bone marrow suppression 686

Red cell transfusion in cancer patients 689

## Spinal cord compression

Spinal cord compression is a medical emergency. Treatment must begin within hours, not days, to maximize the chance of neurological recovery.

Every cancer network should have a clear care pathway for the diagnosis and management of malignant spinal cord compression (NICE clinical guidance).

### Presentation

- Bone involvement from cancer.
- Common in these malignancies:
  - breast
  - prostate
  - lung
  - myeloma
  - lymphoma.
- Less common in:
  - thyroid
  - kidney
  - bladder
  - bowel
  - melanoma
  - 1° bone tumours.
- May be the first presentation of malignancy—prostate, breast, myeloma.
- Crush fracture and/or soft tissue tumour extension common.
- Occasional direct extension from malignant retroperitoneal or mediastinal lymphadenopathy, e.g. lymphoma.
- Occasional extradural tumour mass, causing cord compression in the absence of bone involvement.
- Occasional intramedullary metastases or 1° tumour.
- 66% of cases occur in the thoracic cord.

### Symptoms

(See Table 30.1.)

- Pain, typically radicular, exacerbated by coughing or straining and not relieved by bed rest, frequently precedes neurological symptoms or signs.
- Any patient with cancer who develops severe back pain with a root distribution should be considered at risk of spinal cord compression and urgently investigated.
- Patients with known bone metastases should be encouraged to self-refer without delay.
- Weakness of the legs (and arms if the lesion is cervical), sensory loss, retention, dribbling, or incontinence of urine or faeces are late symptoms.

### Cauda equina syndrome

- The spinal cord ends at the level of L1 or L2.
- Tumours below this level may produce cauda equina compression, with sciatic pain (often bilateral), bladder dysfunction with retention and overflow incontinence, impotence, sacral (saddle) anaesthesia, loss of anal sphincter tone, and weakness and wasting of the gluteal muscles.
- The symptoms may be vague, and the diagnosis difficult to make without imaging of the spine.

**Table 30.1** Spinal cord compression syndromes**Complete compression**

Sensory level just below level of lesion

Loss of all sensory modalities—may be variable at onset

Bilateral upper motor neuron weakness below lesion

Bladder and bowel dysfunction

**Anterior compression**

Partial loss of pain and temperature below lesion

Bilateral upper motor neuron weakness below lesion

Bladder and bowel dysfunction

**Posterior compression**

Loss of vibration and position below lesion

Relative sparing of pain, temperature, and touch

Band of dysthaesia at level of lesion

**Lateral compression (Brown–Séquard syndrome)**

Contralateral loss of pain and temperature (touch relatively spared)

Ipsilateral loss of vibration and position

Ipsilateral upper motor neuron weakness

**Examination**

The following may be present:

- visible or palpable gibbus at the site of a wedged or collapsed vertebra
- pain and tenderness on palpation or percussion of the vertebra over the site of compression
- band of hyperaesthesia at the level of the lesion
- sensory and motor loss (with defects of power and sensation) at and below the level of the lesion
- the lesion may be partial or complete, and the nature of the defect may depend on the portion of the cord compressed.

**Investigations**

- Plain X-rays may demonstrate destruction and/or collapse of a vertebra. Paravertebral masses may sometimes also be shown. In 15–20% of cases, plain films show no abnormality.
- MRI scanning is the investigation of choice. It is advisable to include full spine, as it is not uncommon to find >1 critical lesion. It is particularly useful in cases of cauda equina syndrome.
- Where MRI is not available or contraindicated, myelography will show the anatomical location of a spinal cord lesion and whether a block is complete or not, but CT scanning will frequently yield sufficient information without delay. Simultaneous myelography improves the sensitivity of the investigation.

### Management

- Speed is of the essence in the management of spinal cord compression.
- <10% of patients with established paraplegia from metastatic disease walk again.
- Dexamethasone 16–20mg should be given immediately. This can reduce peri-tumoural oedema.
- If immediate surgery is not contemplated, the neurological status should be assessed at least daily, so that deterioration may be detected early and surgical intervention considered.
- Best outcomes reported with surgical decompression/stabilization of the spine, followed by radiotherapy.
- However, surgery is neither feasible nor appropriate in many, e.g. frailty, extensive bone destruction, extensive disease in other sites, etc.
- Surgery indicated particularly for:
  - acute-onset paraplegia
  - patients with good performance status
  - small-volume bone disease
  - fracture dislocation
  - radioresistant tumours
  - spinal cord compression progressing during radiotherapy or recurrence after radiotherapy
  - to provide tissue diagnosis where cord compression is the presenting symptom of malignancy.
- Radiation-induced oedema may exacerbate symptoms during radiotherapy—may require increase in the dose of steroids during radiotherapy.
- Chemotherapy rarely indicated in the treatment of spinal cord compression, e.g. chemosensitive 1° tumour such as Ewing's.





## Bone marrow suppression

- The major dose-limiting toxicity of cancer chemotherapy is bone marrow suppression.
- Normally between  $10^{10}$  and  $10^{12}$  cells are produced by the bone marrow every hour in a carefully controlled manner.
- Cytotoxic-induced bone marrow failure usually produces a pancytopenia.
- First problems relate to neutropenia, usually 7–10 days after the start of chemotherapy.
- The risk of sepsis relates to the severity and duration of neutropenia.
- If chemotherapy causes coincident mucosal damage, e.g. stomatitis or diarrhoea, this may provide a portal for bacteraemia.
- Days 10–14 may develop thrombocytopenia.
- Anaemia due to marrow suppression commonly occurs on days 14–21.
- Bone marrow compromise may also result from wide-field radiotherapy.
- Certain specific cytotoxics cause preferential damage to stem cells, leading to delayed and prolonged myelosuppression, e.g. CCNU.
- Myelosuppression related to chemotherapy can be graded, using defined criteria—a process useful in clinical trials and in judging the risk in dose-intensive therapy (see Table 30.2).

### Causes of bone marrow failure

- Depletion of anatomical and physiological elements, e.g. myelofibrosis, myelodysplasia.
- Intrinsic stem cell/precursor cell failure, e.g. aplastic anaemia, paroxysmal nocturnal haemoglobinuria.
- Iatrogenic, e.g. chemotherapy, irradiation.
- Bone marrow infiltration, e.g. malignancy.
- Peripheral consumption, e.g. hypersplenism.
- Autoimmune diseases, e.g. SLE.
- Vitamin deficiency, e.g. megaloblastic anaemia.

### Pancytopenia in the cancer patient

- Neutropenia—life-threatening bacterial infections (see Table 30.3).
- Associated with:
  - poor nutrition
  - mucosal barrier defects
  - central venous lines
  - abnormal host colonization.
- Qualitative and quantitative defects.
- Defects in chemotaxis, neutrophil degranulation.

**Table 30.2** National Cancer Institute of Canada–Clinical Trials Group (NCIC–CTG) expanded common toxicity criteria

Toxicity grade	0	1	2	3	4
Hb (g/dL)	WNL	10.0–normal	8.0–9.9	6.5–7.9	<6.5
Platelets ( $\times 10^9/L$ )	WNL	7.5–normal	50.0–74.9	25.0–49.9	<25.0
WCC ( $\times 10^9/L$ )	$\geq 4.0$	3.0–3.9	2.0–2.9	1.0–1.9	<1.0
Granulocytes	$\geq 2.0$	1.5–1.9	1.0–1.4	0.5–0.9	<0.5
Lymphocytes	$\geq 2.0$	1.5–1.9	1.0–1.4	0.5–0.9	<0.5

Hb, haemoglobin; WCC, white cell count; WNL, within normal limits.

**Table 30.3** Most common microorganisms in neutropenic patients

Gram-negative bacilli	Gram-positive bacilli	Fungi
<i>Escherichia coli</i>	<i>Staphylococcus aureus</i>	<i>Candida</i> spp.
<i>Klebsiella</i> spp.	<i>Staphylococcus epidermidis</i>	<i>Aspergillus</i> spp.
<i>Enterobacter</i> spp.	<i>Streptococcus pneumoniae</i>	Mucorales
<i>Proteus</i> spp.	<i>Viridans streptococci</i>	
<i>Pseudomonas aeruginosa</i>	Enterococci	
	<i>Corynebacterium</i>	

### Management of fever in a neutropenic patient

- Fever is common in patients with cancer.
- Commonly caused by infection.
- Can also be related to an underlying malignancy, blood product transfusion, and pyrogenic medications.
- Untreated sepsis in a neutropenic patient can be rapidly fatal.

Generally, antibiotics are administered empirically after careful physical examination and the following simple investigations:

- blood cultures (peripheral and central, if line *in situ*)
- sputum culture
- urine analysis and culture
- CXR
- swabs from Hickman line exit site.

Treatment should then be instituted without delay with empirical IV broad-spectrum antibiotic therapy, particularly if the patient is toxic or haemodynamically compromised. The widespread adoption of this approach has reduced the mortality of neutropenic sepsis to <10%.

- The selection of initial antibiotic regimen should be determined by a locally agreed protocol, guided by the bacteriology department, according to the prevalence of antibiotic sensitivity/resistance.

- Fulminant sepsis requires intensive supportive therapy, with close monitoring and correction of hypoxia, hypotension, fluid balance, acid–base balance, renal function, coagulopathy, etc.
- If the fever is unremitting at 48h, or there is any clinical deterioration, an empirical change of antibiotics to a second-line antibiotic regime should be performed.
- If infection is associated with a central venous access line, removal of the line may be required if there is not a prompt response to appropriate antibiotics.
- Failure to resolve the fever within 5 days may suggest other opportunistic infections such as fungi or parasites, including *Pneumocystis carinii*. Careful consideration of these diagnoses, in close consultation with a microbiologist, is required and may require more invasive investigation, e.g. bronchoscopy and bronchoalveolar lavage.
- Often, resolution of neutropenia is associated with resolution of refractory fever. This process can be accelerated by the prophylactic use of haemopoietic growth factors (e.g. G-CSF), started one day post-chemotherapy. There is no evidence that administering G-CSF at the time of neutropenic sepsis improves the outcome.

### Thrombocytopenia in the cancer patient

- Thrombocytopenia is commonplace in patients receiving cytotoxic chemotherapy.
- The trigger level to transfuse platelets is not always absolute.
- Spontaneous bleeding is unlikely if platelets are  $>20 \times 10^9/L$ , but the risk of traumatic bleeding is greater if  $<40 \times 10^9/L$ .
- Most clinicians would transfuse when platelets are  $<10 \times 10^9/L$ . However, if there is active bleeding or sepsis, platelet transfusion should be considered if platelets  $<20 \times 10^9/L$ .

Careful consideration of the patient's vascular status, clotting status, and disease-specific risks (e.g. gastric carcinoma) will determine the threshold for transfusion in an individual patient. Cross-matching is not required, since patients generally receive random pooled donor platelets.

Some patients may become refractory after repeated transfusions, and HLA-matched platelets should be used for these. Four units of fresh platelets (doubled if platelets  $>3$  days old) should raise the count to  $>24\text{--}40 \times 10^9/L$  in an adult. Although frequently part of the differential diagnosis of refractoriness, HLA allo-immunization is only one of many causes. Others include the presence of:

- anti-platelet antibodies
- DIC
- concomitant drugs, e.g. co-trimoxazole
- hypersplenism.

## Red cell transfusion in cancer patients

- A low Hb in a patient with cancer is also common and requires careful diagnostic evaluation.
- Elimination of obvious causes, such as bleeding from a GI malignancy, is important, before repeated red cell transfusions are given.
- A blood transfusion of 1 unit should raise the Hb by ~1g/dL.
- Transfusion may reduce the platelet count, so platelet transfusion may be required before or after blood transfusion.
- Red cell transfusion should be based on clinical criteria, rather than absolute trigger values, but usually only given when Hb <10g/dL.
- The use of EPO to maintain Hb values in patients with cancer is possible. Recent research suggests that some cancers may also be stimulated by EPO, so it is used with more caution than previously.



# Overview of acute oncology

Overview of acute oncology 692

Further reading 693

## Overview of acute oncology

- Concept of acute oncology developed in response to:
  - National Confidential Enquiry into Patient Outcome and Death (NCEPOD)—*For better, for worse? A review of the care of patients who died within 30 days of receiving systemic anti-cancer therapy* (2008)
  - National Chemotherapy Advisory Group (NCAG) report (2009)
  - NICE guidelines for the management of undiagnosed cancer and the management of malignant spinal cord compression.
- Identified the need for a systematic approach to patients with:
  - cancer-related complications
  - toxicity from treatment for cancer
  - likely malignancy, who have not yet received a diagnosis.
- In response to the increasing burden on hospital services due to:
  - an older spectrum of patients, often with more co-morbidities
  - more available treatment modalities for cancer
  - an increasing incidence of admissions with toxicities from cancer treatment
  - a greater reliance on local district general hospitals (DGHs) to manage acute admissions for patients being treated at distant cancer centres.
- Requirement for all hospitals with an accident and emergency (A & E) to establish an 'acute oncology service' to:
  - coordinate the management of relevant patients (by emergency medicine, acute medicine, and oncology)
  - ensure 24h access to specialist oncology advice
  - routinely audit emergency admissions of patients with cancer
  - ensure compliance with NICE recommendations for the management of undiagnosed cancer (see Chapter 26) and the management of malignant spinal cord compression (see Chapter 30).
- There is considerable flexibility in how each hospital chooses to structure their acute oncology service, depending on local needs and resources. However, typically, there will be an acute oncology specialist nurse who should be readily contactable via the hospital switchboard—involve them early! They should be informed of all patients on chemotherapy who attend A & E. Additionally, they can be extremely helpful in:
  - advising in the management of cancer symptoms and toxicity caused by treatment
  - providing background information and placing the patient in the context of their disease, e.g. prognosis, scope for (further) treatment, etc.
  - minimizing unnecessary investigations (see Chapter 26)
  - liaising with the relevant specialty oncology team, either to arrange inpatient review, swift transfer to specialist wards, or prompt outpatient follow-up.



## Further reading

National Cancer Peer Review—National Cancer Action Team (2011). *National cancer peer review programme. Manual for cancer services: acute oncology—including metastatic spinal cord compression measures* (version 1.0). London: NHS. Available at: [https://www.gov.uk/government/uploads/system/uploads/attachment\\_data/file/216121/dh\\_125889.pdf](https://www.gov.uk/government/uploads/system/uploads/attachment_data/file/216121/dh_125889.pdf).



# Superior vena cava obstruction and raised intracranial pressure

Superior vena cava obstruction *696*

Raised intracranial pressure *700*

## Superior vena cava obstruction

### Aetiology

The SVC can be obstructed by:

- external compression:
  - accounts for >80% of cases of SVCO
  - either from 1° tumour
  - or from metastatic (often paratracheal) lymphadenopathy
- direct invasion from the same causes
- a thrombus within any combination of the above.

The majority of cases are due to:

- cancer:
  - ~75% of cases
  - any tumour involving the mediastinal nodes can cause SVCO
  - most commonly associated malignancies are:
    - NSCLC (~50% of all cases of SVCO)
    - SCLC (15–20% of patients develop SVCO)
    - NHL
  - rarer causes include thymoma, germ cell tumours (<5% cases)
- thrombus:
  - risk factors for SVC thrombus include:
    - underlying malignancy
    - prothrombotic tendency
    - tumour mass causing external compression
    - indwelling intravascular catheters in great veins, e.g. Hickman or PICC.

Benign causes are uncommon but include:

- post-radiotherapy fibrosis
- unusual infections, e.g. aspergillosis
- sarcoidosis.

### Clinical features

#### Symptoms

- SVC syndrome describes the symptoms which arise following obstruction of the SVC.
- Acuteness of the presentation is dependent upon the rate at which obstruction of the SVC occurs, compared to the recruitment of venous collaterals. Typically, symptoms evolve over several weeks and then may improve, as collaterals develop (alternative pathways for the return of venous blood to the right atrium).
- *Dyspnoea*—the most commonly reported symptom, due to associated tracheal or bronchial obstruction/compression.
- *Swelling of the face*—may also include the neck and arms, particularly in the morning; often exacerbated by bending forwards or lying down.
- *Cough*.
- *Headache*—or, less commonly, confusion; due to cerebral oedema.

#### Signs

- Facial oedema.
- Facial plethora.
- Fixed engorgement of the external and internal jugular veins.
- Collateral veins over the anterior and lateral chest wall.

- Arm oedema.
- Cyanosis.
- Papilloedema (late feature).

### Differential diagnoses

- *Heart failure:*
  - jugular veins pulsating, not fixed
  - other cardiac signs
  - dependent oedema.
- *Cardiac tamponade:*
  - characteristic symptoms/signs and CXR appearances.
- *External jugular vein compression:*
  - no facial oedema
  - no collaterals
  - usually SCF nodes.

### Investigations

- Up to 60% of patients with SVCO due to an underlying cancer present without a known diagnosis of malignancy.
- Unless the patient has very severe and life-threatening symptoms (e.g. respiratory failure due to stridor), treatment should not start, until a clear diagnosis (including the pathology, if possible) has been made.

Consider the following.

- *CXR:*
  - abnormal in >80% of cases
  - typical findings can include:
    - a right paratracheal mass,
    - mediastinal lymphadenopathy
    - other indications of lung cancer, e.g. pleural effusion.
- *CT of the thorax:*
  - ideally with contrast
  - usually defines the level and degree of venous blockage
  - additionally assists in identifying the cause of SVCO
  - can also help with staging of the cancer (if includes the abdomen)
  - opportunity for percutaneous biopsy (may confirm the histology).
- *Venogram:*
  - superior for identifying the site/extent of the obstruction
  - does not identify the cause of SVCO (unless thrombus alone)
  - needed if:
    - there is no obvious mass causing an external compression
    - if thrombolysis or stent insertion are planned.
- *Cytology:*
  - the priority is to obtain a histological diagnosis by selecting the most minimally invasive method possible
  - e.g. cytology from SCF nodes or pleural fluid.
- *Bronchoscopy:*
  - essential if the clinical picture and CXR suggest lung cancer, but not yet confirmed histologically.
- *Mediastinal biopsy:*
  - e.g. via mediastinoscopy/mediastinotomy/CT-guided biopsy
  - an alternative method of obtaining histology if other attempts fail.

## Management

- Most patients present with symptoms of insidious onset, and there is time to establish the diagnosis and extent of the disease, prior to treating.
- The prognosis is dependent on the tumour histology and stage of disease at presentation, rather than the presence of SVCO per se. Following a diagnosis of SVCO, the median survival is ~6mo.
- If a patient is severely compromised, assess for concomitant tracheal compression (see Chapter 33).
- In the acute situation:
  - sit the patient up
  - establish IV access
  - 100% O<sub>2</sub>, if appropriate
  - dexamethasone 8mg bd PO/IV:
    - the intent is to reduce any peri-tumoural oedema
    - common practice, although evidence supporting it is lacking
    - some malignancies are steroid-responsive, e.g. lymphoma.
- CXR and CT scan remain essential.
- Involve the patient's own oncologist (if cancer known).
- Alternatively, involve the hospital acute oncology service.
- The aim is for subsequent investigations/management to be specifically tailored to the underlying diagnosis.
- Therapeutic options include:
  - *endovascular stenting*:
    - an expanding metal stent is manoeuvred to the point of the stricture
    - percutaneous insertion
    - usually performed by an interventional cardiologist or a radiologist
    - the treatment of choice, provided it can be instigated rapidly
    - palliation is usually within 24–48h
    - can be used for recurrent SVCO in previously irradiated field
    - can be repeated
  - *thrombolysis*:
    - if the venogram confirms the presence of a clot
    - usually combined with stent insertion (although morbidity is increased)
    - removing an associated Hickman line/PICC usually leads to resolution of SVCO
  - *radiotherapy*:
    - the preference is to obtain histology, prior to commencing
    - may make subsequent histology difficult to obtain
    - no immediate symptomatic benefit
    - the anticipated life expectancy must be several weeks to benefit
    - the intent is usually palliative
    - can be combined with stent insertion
  - *chemotherapy*:
    - may be appropriate first-line management for some chemosensitive tumours causing SVCO, e.g. SCLC, germ cell tumours, some lymphomas
    - palliation of symptoms within 1–2wk.

### Further reading

McCurdy MT, Shanholtz CB (2012). Oncologic emergencies. *Crit Care Med* **40**, 2212–22 (a review of the pathophysiology, diagnosis, and management of the SVC syndrome, malignant pericardial effusion, malignant spinal cord compression, hypercalcaemia, and acute tumour lysis syndrome).

## Raised intracranial pressure

### Background

The rigid bony skull surrounding the brain is resistant to any increase in the volume of its contents, with any such change leading to a rise in the ICP and/or displacement of brain structures. The skull contents comprise:

- the brain and interstitial fluid (80%)
- intravascular blood (10%)
- CSF (10%).

An increase in the volume of any one component may be accommodated by a reduction in another, in order to maintain physiological ICP (10–20cmH<sub>2</sub>O). When malignancy involves the brain, these physiological regulatory mechanisms are commonly overcome, leading to raised ICP.

### Aetiology

- Localized mass lesions:
  - neoplasms (metastasis, glioma, meningioma, etc.)
  - focal oedema 2° to tumour, infarction, or trauma
  - traumatic haematomas (extradural, subdural, or intracerebral)
  - abscess.
- Disturbance of CSF circulation:
  - obstructive hydrocephalus
  - communicating hydrocephalus.
- Obstruction to major venous sinuses:
  - cerebral venous thrombosis
  - depressed fracture overlying major venous sinuses.
- Diffuse brain oedema:
  - encephalitis, meningitis
  - diffuse head injury, subarachnoid haemorrhage
  - water intoxication, near drowning.
- Idiopathic:
  - benign intracranial hypertension.

### Pathogenesis of tumour-related raised intracranial pressure

It should be remembered that patients with malignancy may be at risk of developing non-malignant raised ICP, as a consequence of treatment, e.g. coagulopathy-associated intracranial haemorrhage or CNS infection in an immunocompromised individual.

Of the neoplastic lesions causing raised ICP, more than half are due to metastatic disease, the remainder comprising 1° brain tumours, of which gliomas are the commonest. Malignant disease in the CNS can produce a rise in ICP through:

- mass effect
- vasogenic oedema—capillary leakage is associated with the abnormal tumour vasculature
- haemorrhage from the tumour (especially melanoma, choriocarcinoma, renal cancer)
- hydrocephalus:



- obstruction of CSF flow, e.g. pineal tumour obstructing the aqueduct of Sylvius prevents the drainage of CSF from the third to fourth ventricle
- meningeal metastases may reduce the reabsorption of CSF with resulting communicating hydrocephalus.

### Clinical features

- Early stages—typically, symptoms are headache and nausea/vomiting.
- Often worse in the morning because of cerebral venous congestion associated with lying supine.
- Coughing or sneezing may aggravate the headache.
- As pressure increases, there may be cognitive impairment and drowsiness, caused by the caudal displacement of the midbrain, heralding a more rapid neurological deterioration.
- Herniation of cerebral tissue through the tentorium may cause midbrain compression, with coma associated with pupillary and oculomotor signs and altered regulation of respiration and cardiovascular control, with bradycardia and hypertension.
- Fundoscopy will reveal papilloedema in 50%, and there may be associated neurological deficit.
- Specific signs may suggest the site of pathology, e.g. Parinaud's syndrome, with limitation of upward gaze associated with pineal tumours.
- Raised ICP may cause hyponatraemia through SIADH.
- When the increase in ICP is more gradual, the presentation may be with memory loss, behavioural changes, and altered gait.
- Meningeal malignancy commonly causes cranial nerve palsies, in addition to raised ICP.

### Diagnosis

Usually addressed by contrast-enhanced CT or MRI scan.

- Unenhanced CT may show mass lesion(s) and associated haemorrhage (hyperdense).
- Surrounding oedema and/or hydrocephalus.
- CT with IV contrast demonstrates lesion enhancement in the majority of CNS malignancies.
- MRI undoubtedly has superior sensitivity in the detection of CNS malignancy.
- Where CT shows a solitary tumour, MRI will reveal >1 lesion in at least 20%.
- On MRI, the tumour appears iso- or hypodense on T1-weighted images and hyperdense on T2, and enhances with contrast.
- MRI gives superior definition of the anatomical detail and may demonstrate meningeal spread of the malignancy.

### Management

- Early management:
  - reduce vasogenic oedema with high-dose dexamethasone (16mg daily) with PPI gastroprotection
  - in non-responding patients, osmotic diuresis with IV mannitol (100mL of 20% solution over 1–2h).

- Contact the relevant oncology team if the patient known to have malignant disease.
- Alternatively, contact the hospital acute oncology team.
- Further management will depend on the diagnosis and may include:
  - neurosurgical intervention:
    - e.g. biopsy or excision of the tumour mass, consideration of a shunt for hydrocephalus, drainage of haematoma or abscess
  - systemic chemotherapy for chemosensitive disease:
    - e.g. CNS lymphoma
  - cranial radiotherapy:
    - e.g. multiple metastases
  - antibacterial or antiviral therapy, if appropriate
  - symptom control only:
    - e.g. if poor prognosis, metastatic disease in the brain and elsewhere not responding to systemic therapy.

# Airway obstruction

Aetiology 704

Presentation 705

Management and investigation 706

Treatment of malignant airways obstruction in  
stable patients 708

Further reading 710

## Aetiology

### Malignant

- Intrinsic upper airway disease:
  - 1° tumours of the:
    - upper airway, e.g. bronchogenic, SCLC
    - larynx, e.g. laryngeal carcinoma
    - hypopharynx
    - subglottis
  - local extension of a bronchial tumour invading the carina
  - metastatic endobronchial disease affecting the upper airway
    - e.g. bronchogenic, breast, melanoma, renal cell, occasionally carcinoid tumour.
- Extrinsic compression:
  - mediastinal neoplasm
    - e.g. anaplastic thyroid cancer, germ cell tumour, thymic carcinoma, oesophageal cancer
  - lymphadenopathy:
    - e.g. from (typically NHL) lymphoma or metastatic carcinoma.

### Benign

- Lymphadenopathy, e.g. sarcoidosis, tuberculosis.
- Inhaled food/foreign body/mucus plug/blood clot.
- Tracheal stenosis, e.g. post-tracheostomy, granulation tissue.
- Bilateral vocal cord palsy, e.g. post-thyroid surgery.
- Infective, e.g. epiglottitis.

## Presentation

Typically insidious, e.g. slow compression by mediastinal tumour. Occasionally acute when subcritical obstruction further compromised, e.g. by haemorrhage, infection, or swelling.

### Symptoms

- Stridor—a high-pitched noise generated by the turbulent flow of air through a partially obstructed airway.
- Shortness of breath.
- Wheeze unresponsive to bronchodilators.
- Exacerbation of background symptoms due to common co-morbidities, e.g. coexistent COPD in a patient with lung cancer.
- Cough  $\pm$  sputum production  $\pm$  haemoptysis.
- Recurrent (incompletely resolving) pneumonias.
- Difficulty swallowing or drooling.
- Drowsiness, collapse.

### Signs

- The timing of stridor may suggest the site of the obstruction:
  - *inspiratory stridor*—with extra-thoracic, supraglottic, or glottic obstruction
  - *biphasic stridor*—with glottic or subglottic obstruction
  - *expiratory stridor*—with intrathoracic tracheal obstruction.
- Dyspnoea.
- Tachycardia.
- Cyanosis.
- Features of an underlying malignancy:
  - e.g. goitre, clubbing, weight loss, Horner's syndrome, disseminated lymphadenopathy.

## Management and investigation

- *The priority is to stabilize a distressed patient:*
  - sit the patient up
  - assess for ventilatory failure by checking arterial blood gases (ABGs)
  - if exhausted or in respiratory failure (i.e. arterial oxygen tension ( $\text{PaO}_2$ )  $\leq 10\text{kPa}$ , arterial carbon dioxide tension ( $\text{PaCO}_2$ )  $\geq 6\text{kPa}$ ), consider involving the ICU or ENT
  - 100%  $\text{O}_2$
  - establish IV access
  - rarely, an emergency tracheostomy may be required to preserve the airway, before appropriate treatment is initiated.
- *If the patient is stable, consider the following:*
  - full history/obtain old notes to establish if the diagnosis/staging of an underlying malignancy has been confirmed
  - involve the patient's own oncologist or the hospital acute oncology service for guidance regarding the appropriate level of intervention
  - FBC—to exclude anaemia as an exacerbating factor
  - CXR—rarely diagnostic, but may demonstrate mediastinal widening (lymphadenopathy), 1° lung cancer, other evidence of an underlying malignancy, e.g. pleural effusion or an exacerbating pneumonia
  - CT scan of the thorax—may identify the site of obstruction and indicate the extent of the disease (prognostic implications)
  - flow-volume loops—may demonstrate the characteristic pattern of airways obstruction
  - indirect laryngoscopy—to assess the mobility of the cords
  - bronchoscopy for the:
    - direct visualization of the site of obstruction
    - differentiation between intrinsic and extrinsic lesions
    - potential histological confirmation of the diagnosis
  - fiberoptic nasoendoscopy
  - mediastinoscopy.



## Treatment of malignant airways obstruction in stable patients

- This is dependent upon:
  - the underlying cause
  - previous therapy
  - the likely prognosis.
- Involve the patient's own oncologist or the hospital acute oncology service, whenever possible.
- Treatment to initiate immediately may include:
  - supplemental O<sub>2</sub>
  - opiates for the distressing sensation of breathlessness ± anxiolytics, typically benzodiazepines
  - nebulized bronchodilators, e.g. salbutamol, may relieve coexistent bronchospasm
  - suction to remove pooled secretions (can exacerbate distress)
  - high-dose steroids, with the aim of reducing peri-tumoural oedema and hence partially relieving obstruction, e.g. dexamethasone 8mg bd PO/IV. Little evidence base for this approach and no immediate benefit.
- Longer-term treatment strategies may include:
  - *laser debulking*:
    - immediate effect
    - may be helpful in bulky exophytic laryngeal tumours
    - also useful if the cancer is resistant to radiotherapy, e.g. metastatic melanoma
    - benefit generally not long-lasting
    - often used prior to more durable treatment, e.g. radiotherapy
  - *EBRT*:
    - therapeutic effects are delayed (4–6wk)
    - used for most patients with NSCLC
    - the intent is usually palliative
    - appropriate in some other cancers, e.g. renal cell cancer
    - occasionally initiated in the absence of histology (in clinically urgent circumstances)
    - anecdotal concern that radiotherapy may initially worsen peri-tumoural oedema, and all such patients should receive steroids
  - *endobronchial brachytherapy* (single fraction):
    - an option in recurrent obstruction
    - can be used following previous EBRT
    - dependent on establishing a patent airway first, e.g. by laser debulking
  - *endoluminal stenting by bronchoscopy*:
    - may produce useful palliation in cases of recurrent malignancy affecting the trachea, obstruction due to extrinsic causes
    - may prevent reocclusion
    - causes of subsequent failure include tumour overgrowth, stent migration
    - can be repeated



- *surgical resection*:
  - limited role
  - salvage therapy, e.g. for recurrent laryngeal cancer
  - more rarely, may be first-line management, e.g. 1° carcinoid tumour of the trachea, solitary renal cell metastasis
- *chemotherapy*:
  - can be an appropriate 1° treatment for airway obstruction due to chemosensitive tumours, e.g. small-cell carcinoma, lymphoma, germ cell tumours.

## Further reading

Gompelmann D, Eberhardt R, Herth FJ (2011). Advanced malignant lung disease: what the specialist can offer. *Respiration* 82, 111–23 (this includes sections on options in the prevention and management of malignant central airway stenosis).

# Thromboembolic and cardiac emergencies

Thromboembolic disease and cancer 712

Disseminated intravascular coagulation and malignant disease 715

Cardiac disease and cancer 716

Further reading 718

## Thromboembolic disease and cancer

### Scale of the problem

- Up to 90% of cancer patients exhibit activation of the coagulation pathways.
- 4–20% develop DVT and/or PE (VTE).
- The risk has increased over the last 20y, likely due to anti-cancer treatments, e.g. hormone therapy, chemotherapy, and, more recently, targeted therapies against angiogenesis.
- Arterial thrombotic events are also increased (1–4%).
- May account for 9% of deaths in patients receiving chemotherapy.
- Prophylactic treatment should be effective for many at-risk patients.
- Patients who present with idiopathic thrombosis, without a history of malignancy, are at increased risk of occult cancer and warrant CXR, full physical examination, including rectal and gynaecological assessment, FOBs, and PSA (only patients with positive clinical findings require further investigation, e.g. CT scan).

### Mechanisms of coagulopathy

The molecular basis is uncertain; proposed causes include:

- the activation of coagulation by tissue factor in tumours
- factor X-activating cysteine protease
- mucinous glycoproteins
- *MET* oncogene activation.

### Prevention of venous thromboembolism

Prophylaxis with low-molecular-weight heparin (e.g. dalteparin 3400–5000 units s/c daily) reduces the risk of VTE by 40–80% and is recommended for:

- patients undergoing major cancer surgery
- patients with cancer who are confined to bed, e.g. acute medical admissions
- ambulatory patients receiving chemotherapy who are deemed to be at high risk (see Table 34.1):
  - high-risk pathology
  - high-risk treatments
  - past history of DVT.

Contraindications to prophylactic anticoagulation include:

- active bleeding, e.g. 1° tumour, CNS metastasis, peptic ulcer
- thrombocytopenia or clotting dysfunction, e.g. hepatic metastases.

Randomized trials using an alternative approach—low-dose warfarin 1mg daily—in patients receiving chemotherapy via central venous access have shown this to be ineffective in reducing thrombotic events, although some have demonstrated a reduction in line-related costs. Indeed, experience has shown that it is necessary to frequently monitor the INR when warfarin is given during chemotherapy, not least because of interactions between several cytotoxics and warfarin.

**Table 34.1** Risk factors for VTE in patients with malignant disease**Patient-related factors:**

- co-morbidity, e.g. obesity, infection, COPD, arteriopathy
- past history of VTE

**Cancer-related factors:**

- 1° site—GI tract, brain, lung, gynaecological
- metastatic disease

**Treatment-related factors:**

- recent surgery
- current hospitalization
- ongoing chemotherapy or hormone therapy
- anti-angiogenic therapy
- central venous catheter

**Treatment of venous thromboembolism in cancer patients**

Standard treatment of VTE with an initial therapeutic dose of low-molecular-weight heparin and warfarin is problematic in cancer patients because of:

- an unpredictable response to warfarin, e.g. deranged hepatic metabolism in metastatic disease, drug interactions, e.g. capecitabine
- inconvenience of frequent monitoring of INR
- high rate of recurrent VTE on warfarin
- high rate of bleeding on warfarin
- for many patients, the preferred option is long-term therapeutic dose of low-molecular-weight heparin injections, and promising results with this approach suggest it may also have an added benefit of enhancing the anti-tumour effects of chemotherapy, e.g. in SCLC.

**Thrombolytic treatment**

Urokinase infusion indicated if:

- PE with severe right ventricular dysfunction
- massive iliofemoral thrombosis with the risk of limb gangrene

**Vena cava filter**

- Indicated for patients with VTE and contraindication to anticoagulant therapy.
- Also patients with recurrent VTE, despite adequate therapy with low-molecular-weight heparin.

Both thrombolysis and IVC filter insertion require the assistance of interventional radiologists.

**Heparin-induced thrombocytopenia**

Falling platelet counts during heparin therapy can be associated with severe thrombotic tendency, even resulting in massive thrombosis and limb gangrene. Management comprises the following:

- withdraw heparin
- consider switch to danaparoid, rather than warfarin, particularly if the platelet count does not rise immediately.

**Arterial thromboembolic disease**

During the early randomized studies of adjuvant chemotherapy and hormone therapy for breast cancer in the 1970–80s, it was noted that 1.6% of pre-menopausal women developed arterial thromboses when treated with both chemotherapy and tamoxifen. Since then, other observations have included:

- sporadic cases of MI and cerebrovascular accident (CVA) reported during chemotherapy for testicular cancer since 1980
- association with smoking, obesity, elevated cholesterol, diabetes
- more frequent cases of acute lower limb ischaemia, as well as cardiac and cerebrovascular events, following cisplatin-based chemotherapy for, e.g. lung cancer and other smoking-related malignancies
- carboplatin appears less likely to cause vascular damage
- the mechanism underlying acute ischaemia post-chemotherapy still uncertain
- other cytotoxics, e.g. fluorouracil and capecitabine, associated with coronary artery spasm, rather than thrombosis.

There have been no formal trials of prophylactic therapy against arterial thromboembolism, but it would seem prudent to adopt the following:

- low-dose aspirin and a statin should be considered for smokers not already taking these, who are receiving chemotherapy, in particular cisplatin
- unless there is strong evidence of inferior anti-cancer efficacy (e.g. testicular cancer), carboplatin should be considered, instead of cisplatin, for patients with existing vascular disease requiring platinum-based chemotherapy.

# Disseminated intravascular coagulation and malignant disease

## Definition

DIC is an acquired disorder characterized by widespread activation of coagulation, resulting in:

- intravascular formation of fibrin
- thrombotic occlusion of small and mid-sized vessels
- multiorgan failure
- severe bleeding.

## Aetiology in cancer patients

- Septicaemia, usually in combination with neutropenia.
- Direct effect of malignancy:
  - 5%, particularly prostate and GI cancers
  - 15% of patients with acute leukaemia (especially acute pro-myelocytic leukaemia).

## Pathogenesis

- Thrombin generation is mediated by plasma tissue factor, released in response to infection or by the tumour itself.
- Anticoagulation pathways are impaired, with low levels of antithrombin III.
- Fibrinolysis is suppressed by plasminogen activator inhibitor type 1.
- The combination of increased formation of fibrin and its inadequate removal results in disseminated intravascular thrombosis.

## Clinical and laboratory features

- Bleeding tendency.
- Thrombotic organ damage.
- Renal failure.
- Thrombocytopenia.
- Prolonged clotting times.
- Presence of fibrin degradation products in plasma.
- Low plasma antithrombin III.

## Management

- The mainstay of treatment is to tackle the underlying cause:
  - appropriate antibiotic therapy for sepsis
  - effective treatment for the underlying malignancy.
- Supportive measures appropriate to the individual presentation:
  - heparin anticoagulation
  - replace platelets and clotting factors (fresh frozen plasma if bleeding)
  - anti-fibrinolytic agents, e.g. tranexamic acid.

Unless the underlying pathology is sensitive to treatment, the prognosis is very poor indeed.

## Cardiac disease and cancer

Patients with cancer frequently develop common cardiac problems such as infarction, failure, or arrhythmias. This can be unrelated to their malignancy, due to smoking, ageing, infection, etc. Alternatively, cardiac problems may arise through:

- direct tumour extension to the pericardium, heart, or great vessels
- thromboembolic disease, e.g. PE
- tumour embolus, e.g. from hepatic metastasis to the right side of the heart
- metabolic effects of cancer, e.g. hypokalaemic alkalosis due to ectopic ACTH production, release of adrenaline by pheochromocytoma, or of 5-HT<sub>3</sub> by carcinoid tumour
- effects of treatment:
  - post-operative arrhythmias
  - chemotherapy, e.g. anthracyclines, trastuzumab, sunitinib may all reduce the left ventricular ejection fraction
  - radiotherapy, e.g. chest wall irradiation after surgery for breast cancer, with late effects on the coronary arteries and cardiac muscle.

### Pericardial effusion

Thoracic malignancies, such as lung cancer, mesothelioma, or metastatic disease, can result in pericardial effusion.

- Presents with acute dyspnoea ± central chest pain.
- Rapid accumulation of fluid or pericardial stiffening due to the tumour can result in tamponade, with worsening symptoms, including orthopnoea, cough, and syncope.
- Heart sounds muffled ± pericardial rub and apex beat not detectable.
- Low BP and pulsus paradoxus.
- Low-voltage ECG.
- Typical CXR appearances—increased cardiothoracic ratio, enlarged globular heart.
- Confirm by echocardiography.
- Aspiration and cytological examination of the effusion may aid diagnosis.
- Symptomatic collections may require urgent assessment and intervention.
- Can be drained by needle (usually under radiological control) or by surgical procedure of 'pericardial window' formation.
- Treat the underlying cancer.

### Marantic endocarditis

Non-bacterial thrombotic endocarditis is characterized by:

- platelet–fibrin vegetations on the cardiac valves (especially mitral and aortic)
- 40% have emboli (digital arteries, spleen, kidney, brain, heart)
- may have associated DIC.

Treat with low-molecular-weight heparin and, if possible, an effective systemic treatment for malignancy.



### Tumours of the heart and great vessels

- Metastatic disease involving the heart, found in 1.5–21% of autopsies.
- 1° cardiac tumours are rare.
- Present with arrhythmias, heart failure, valvular dysfunction and murmurs, and arterial emboli.
- 75% benign, e.g. atrial myxoma.
- 25% malignant:
  - rhabdomyosarcoma, leiomyosarcoma
  - poor prognosis, with high risk of metastatic disease.
- Tumours of large arteries and veins also very rare, the latter presenting with extensive DVT.

## Further reading

- Lee AY (2007). The effects of low molecular weight heparins on venous thromboembolism and survival in patients with cancer. *Thromb Res* **120** (Suppl 2), S121–7.
- Lyman GH, Khorana AA, Falanga A, et al. (2007). American Society of Clinical Oncology guideline: recommendations for venous thromboembolism prophylaxis and treatment in patients with cancer. *J Clin Oncol* **25**, 5490–505.
- Mandala M, Falanga A, Roila F (2008). Management of venous thromboembolism in cancer patients: ESMO clinical recommendations. *Ann Oncol* **19** (Suppl 2), ii126–7.

# Obstruction

Intestinal obstruction 720

Urinary tract obstruction 724

Biliary obstruction 726

Further reading 730

## Intestinal obstruction

### Aetiology

Cancer-related intestinal obstruction usually affects the colon or small intestine and is predominantly associated with ovarian (5–51%) or colonic (10–28%) cancers.

The obstruction may be intraluminal (e.g. colonic cancer) or extramural compression (e.g. ovarian).

In ovarian and cervical cancers, there are often multiple levels of obstruction due to disseminated peritoneal disease.

Obstruction in a patient with a previously treated cancer may also be due to tumour recurrence or to non-malignant causes such as adhesions or radiotherapy-related strictures, and the aetiology requires careful consideration in each individual case.

Functional obstruction may also be caused by cancer-related or drug-related (vincristine) autonomic neuropathy, direct involvement of the mesenteric plexus, or ileus (e.g. due to perforation).

In cancer-related obstruction, the degree of obstruction is usually progressive over time, in particular if related to the tumour.

However, it is important to remember that less common, but reversible, causes include electrolyte disturbances (hypercalcaemia or hypokalaemia), faecal impaction, post-operative adhesions, or herniae.

### Presentation

- Symptoms—nausea, vomiting (gastric outlet—large-volume projectile; large bowel—faeculent), colicky pain, constipation, distension, increased bowel sounds.
- Signs—distension, dehydration, succussion splash (gastric outlet obstruction), bowel sounds (may be absent or high-pitched), pain, peritonism. Pain and peritonism are grave signs and indicate the need for consideration of an urgent intervention.

### Investigations

Erect and supine plain abdominal radiographs are the first-line investigation. These often confirm the presence of an obstruction but rarely identify its aetiology. Where the diagnosis is not clear, the standard investigation is CT, as it indicates the level of obstruction and usually confirms the underlying cause. An alternative for suspected colonic obstruction is an unprepared contrast enema.

Occasionally, endoscopy of the upper or lower intestinal tract may allow the visualization of the area of obstruction, allowing biopsy, confirmation of the diagnosis, and planning of appropriate therapy.

### Management options

Appropriate resuscitation will be guided by clinical and biochemical assessments of dehydration and electrolyte disturbance.

IV fluids and NG suction are usually instigated but *may* not be necessary if patients have advanced disease and are following a palliative pathway. An NG tube relieves the discomfort and nausea associated with obstruction but may predispose to aspiration.

If active treatment is appropriate, surgery may need to be considered after careful multidisciplinary discussion. It is important that electrolyte and fluid balance is optimized prior to surgery to reduce the risk of perioperative complications.

### Medical management

- Inoperable intestinal obstruction can be managed medically. This may permit the patient to be cared for at home. The patient can eat and drink small amounts. Treatment approaches vary, depending on the degree of obstruction present. The aim is to remove the debilitating feeling of nausea and reduce the frequency of vomiting to a level acceptable to the patient.
- The symptoms to be palliated are nausea, vomiting, pain, and constipation. Oral medication may be poorly absorbed in GI obstruction, and the s/c or rectal route should be considered.

#### *Pain*

For colic, an anti-spasmodic—hyoscine butylbromide 80–120mg over 24h via continuous s/c infusion—is usually effective. Avoid prokinetic anti-emetics (metoclopramide) if colic is a problem. Pain from cancer or metastases usually requires parenteral analgesics (e.g. diamorphine given s/c over 24h via a syringe driver, or transdermal fentanyl).

#### *Nausea and vomiting*

- If partial obstruction without colic is present, metoclopramide, 80–120mg over 24h s/c, may stimulate an effective bowel motility. This can be combined with high-dose dexamethasone, 16mg/24h, to reduce peri-tumoural oedema and also serve as an anti-emetic. As vomiting is controlled, introduce oral laxatives, as tolerated.
- If the obstruction is complete or if colic is present, cyclizine, 100–150mg/24h s/c, is given with hyoscine butylbromide. Haloperidol, 5–15mg/24h, is a suitable alternative. Haloperidol, cyclizine, and hyoscine are all miscible with diamorphine in a driver syringe.
- Levomepromazine is a highly specific 5-hydroxytryptamine (5-HT<sub>2</sub>) antagonist and has inhibitory effects on other emetic pathway receptors. It is a useful alternative to the aforementioned anti-emetics and is also miscible with diamorphine. If vomiting persists, then octreotide, 300–600mg/24h via continuous s/c infusion—a somatostatin analogue—can be used. This drug is anti-secretory and promotes the reabsorption of electrolytes, and hence water from the bowel.
- If the obstruction is due to a very chemosensitive tumour, such as a lymphoma, small-cell tumours, or testicular cancer, a trial of chemotherapy may be appropriate. However, this is potentially hazardous and requires close monitoring. In the case of lymphomas of GI origin, the chemotherapy can be very effective, but treatment may lead to perforation, and so this must be borne in mind.
- The patient with an oesophageal or duodenal obstruction may benefit from local radiotherapy. If this is an option, a stent should be inserted first, as the benefit from the latter may not be seen for 6wk, and the radiotherapy itself may lead to worsening obstruction in the short term due to oedema.
- Stenting is also an option for left-sided colonic obstructions, either as a definitive procedure or as a bridge to further therapy.

**Surgical treatment**

The surgical options available will depend on the location and stage of the tumour.

Patients with oesophageal tumours may present with obstruction, reporting dysphagia. In such cases, the patient will require a full work-up to determine if the lesion is resectable, and, if so, an oesophagectomy may be appropriate. If not, then a metal stent may be inserted to offer palliation. For proximal tumours, which are commonly squamous carcinomas, radiotherapy may also be beneficial to aid in the relief of obstruction. Laser therapy may also be beneficial in palliating an obstructed oesophagus.

Gastric outlet obstruction due to carcinoma may be treated by gastrectomy or stenting. Gastrectomy may be worthwhile, even in advanced disease, as a means of symptom resolution.

The relief of duodenal obstruction will depend on the local extent of the disease, as well as the presence of metastases. Lesions in the periampullary region (pancreatic head, ampulla, common bile duct, and duodenum) may all cause duodenal obstruction, this being the case in 30% of patients presenting with these tumours. These lesions have to be carefully staged, as, by the time the duodenum is obstructed, the superior mesenteric vessels or coeliac axis may be invaded by the tumour, rendering the lesion unresectable. In such cases, options in a fit individual would include a biliary and gastric bypass or combined biliary and duodenal stenting. For obstruction of the distal duodenum, resection or bypass are appropriate options, as stenting is often not possible—again there are important anatomical considerations.

For localized obstruction of the jejunum and ileum, resection and anastomosis are appropriate, and, for advanced disease, an internal bypass may be necessary, or even an ileostomy, to relieve the obstruction.

Management of colonic obstruction depends on the location and extent of the disease. The preferred option is resection and 1° anastomosis, where possible, with on-table lavage of the colon if this is indicated. For obstructing left-sided lesions, a Hartmann's procedure is another option and includes excision of the 1°, with a colostomy, and allows for potential re-anastomosis. The whole colon must be evaluated carefully to look for synchronous 1° tumours, as most emergency colectomies are performed without prior evaluation of the colon, and the presence of an additional tumour may change the nature of the operation performed. The caecum must also be carefully inspected, as, if this is not viable, a total colectomy may be required.

For distal lesions, if resection is not possible, then a defunctioning colostomy may be the only option.

The risks of bowel surgery in patients with advanced cancer include:

- multiple levels of bowel obstruction due to intraperitoneal tumour seeding
- poor anaesthetic risk due to generalized debility
- poor surgical healing due to malnutrition, chemotherapy, or tumour seeding
- high risk of thromboembolic events
- early mortality and morbidity.

There is an increasing use of laparoscopic procedures to deal with obstruction, in particular that of the proximal GI tract, although, at present, the reported experience is mainly from specialized units. It is more difficult to deal with colonic obstruction laparoscopically, as the space within the peritoneal cavity is limited in the presence of a markedly distended colon, and so there is currently little in the way of supportive evidence. Laparoscopic surgery is beneficial, as it is associated with less surgical stress and a more rapid recovery. However, the danger of perforating distended bowel with the trocar is very real—such laparoscopic surgery requires an expert and experienced operator.

## Urinary tract obstruction

### Aetiology

The commonest causes of urinary tract obstruction in patients with cancer are:

- carcinoma of the prostate or bladder (trigone)—when the urethra or ureteric orifices become occluded or involved
- carcinoma of the cervix or other carcinoma involving the pelvis, leading to obstruction or involvement of the ureters
- retroperitoneal mass compressing the ureters—this may be malignant in nature
- TCC of the ureters
- fibrosis following surgery, chemotherapy, or radiotherapy.

### Symptoms

The gradual onset of unilateral ureteric obstruction is often asymptomatic. It is often found as an incidental finding of hydronephrosis on a radiological scan requested for other symptoms or for restaging.

Acute ureteric obstruction may cause painful spasm or dull aching in the flank. There can be associated radiation of the pain in the distribution of the L1 nerve root. Visible haematuria 2° to the obstructing process can cause clot colic.

Bilateral gradual obstruction becomes symptomatic, as the serum urea rises above 25mmol/L. The symptoms are related to acute renal failure. Ultimately, the kidney injury leads to anuria, with lethargy, drowsiness, confusion, and nausea.

### Investigations

Selective use of abdominal ultrasound, IVU (contraindicated in uraemic patients), cystoscopy and retrograde ureteric studies, isotope renogram (assesses the function of each kidney), and CT scan of the abdomen are helpful.

CT of the abdomen with IV contrast as a single modality provides the most information by defining any extra-ureteric pathology, although care must be taken with the use of IV contrast in renal impairment. Contrast should be used with caution for two reasons. First, the contrast will not be excreted, as creatinine rises and the renal function deteriorates. More importantly, the contrast agents are nephrotoxic and can cause further patient compromise.

CT is now replacing the IVU as the imaging of choice. Cystoscopy is useful to define intravesical pathology.

### Management options

Bladder outlet obstruction causes symptoms of acute urinary retention or chronic obstruction, with overflow incontinence relieved by urethral or suprapubic catheterization. Bladder outflow surgery can also be used to relieve the symptoms.

Ureteric decompression can be accomplished by:

- percutaneous nephrostomy, with or without antegrade stenting
- cystoscopy and retrograde placement of an internal ureteric stent. This may be difficult if the ureteric orifices cannot be identified.



Ureteric stents need to be replaced every 6mo in patients with cancer, although modern stents may last longer. With extrinsic compression of the ureters, patients can suffer with recurrent admissions due to stent blockages. So permanent nephrostomies may be better, in terms of the QoL in the terminal setting.

Percutaneous nephrostomy can be a temporary measure and appropriate in the following specific circumstances:

- undiagnosed malignant disease
- prostatic or cervical 1°, with an available treatment modality with a reasonable chance of response
- in patients with malignancy in the pelvis, it may be impossible to cannulate the ureters, and a nephrostomy may be essential.

Patients with advanced cancer can gain symptomatic benefit from nephrostomy/ureteric stent insertion. However, since a nephrostomy drain may remain *in situ* for several months, it is prone to dislodgement, infection, and leakage around the site. Double pigtail ureteric stents should be inserted, in preference to a long-term nephrostomy (where possible).

Complications include transient bacteraemia, sepsis, haemorrhage, and obstructive encrustations. Care must be taken in these patients to ensure dehydration, fluid overload, and hyperkalaemia are corrected. The latter is a true emergency, and ultimately it will lead to arrhythmias and cardiac arrest.

- In very selected patients, there are indications for dialysis such as increasing hyperkalaemia, fluid overload resistant to diuretics, and severe renal failure and acidosis. Other problems may include a significant bleeding tendency due to platelet dysfunction. Hypertension is occasionally a problem and requires fluid management and/or anti-hypertensives.
- Any manipulation of the obstructed urinary tract requires antibiotic cover, as these patients are prone to bacteraemia/septicaemia.
- Patients with urinary tract obstruction require MDT management; prolonged survival, even with pelvic malignant disease, is still possible. In one series, the median survival was 26wk.
- There were four groups in this series:
  - group 1—1° untreated malignancy
  - group 2—recurrent malignancy with further treatment options
  - group 3—recurrent malignancy with no further treatment options
  - group 4—benign disease as a consequence of previous treatment.
- Patients in groups 1 and 2 had similar survival—median survival of 27 and 20wk, 5y survival of 20% and 10%, respectively.
- Patients in group 3 had a poor prognosis, with median survival of 6wk and no patient surviving beyond 1y.
- Patients in group 4 had the best outlook, with a 5y survival of 64%.

If the patient has advanced pelvic malignancy, for which there is no treatment, then the QoL and the patient's own wishes should be considered, before intervention to relieve the obstruction is initiated.

## Biliary obstruction

### Aetiology

There are many causes of jaundice in the patient with a history of malignant disease, and the jaundice may have an aetiology other than the malignant process itself.

Classically, the causes of jaundice can be divided as follows:

- pre-hepatic—increased production of bilirubin:
  - haemolytic anaemia
- intrahepatic—decreased uptake of bilirubin:
  - Gilbert's syndrome
  - drugs
  - portacaval shunts
- extra-hepatic—decreased excretion of bilirubin:
  - hepatotoxic drugs
  - viral hepatitis
  - obstruction of the intra- or extra-hepatic biliary tree.

It is important, in principle, not to focus only on the cancer causes in every patient with jaundice who has a history of cancer. Jaundice is not always due to the recurrence of the cancer or complications of same.

Patients must be carefully assessed to ensure that they are adequately investigated (where appropriate), so that non-cancerous causes of the obstructive jaundice can be dealt with appropriately. *In terms of a malignant process, jaundice may be the initial presentation, such as in the case of pancreatic carcinoma, or may represent diffuse infiltration of a metastatic tumour. It is therefore critical to obtain an accurate diagnosis to optimize treatment.*

### History

- Abdominal pain.
- Duration of jaundice and whether the jaundice fluctuates.
- Fever.
- Itching.
- Dark stools and pale urine.
- In particular, it is important to assess whether or not the patient has signs of sepsis. Rigors may be reported and would indicate the need for consideration of an urgent biliary decompression.
- A careful drug history is important, as a number of drugs can cause hepatic toxicity, e.g. cisplatin and oxaliplatin can cause cholestasis. Similarly, some of the anti-metabolites, such as cytarabine, may cause self-limiting abnormalities of the liver function, often with a cholestatic pattern. A similar pattern can arise with mercaptopurine and MTX:
  - some hormonal agents, such as tamoxifen, can occasionally cause abnormal liver function with a fatty liver
  - it is also important to take a detailed history of other drug therapies, such as paracetamol, antibiotics, and antifungal agents, all of which can cause liver abnormalities
  - total parenteral nutrition can cause fatty infiltration and intrahepatic cholestasis.

## Examination

If there has been a previous malignancy, there may be signs of disease recurrence such as an abdominal mass. There may be additional signs, including anaemia, evidence of chronic liver disease, a palpable liver, the presence of ascites, or a palpable spleen. The discovery of a palpable gall bladder, in the presence of painless jaundice, is associated with an aetiology such as pancreatic carcinoma.

### Courvoisier's law

If, in the presence of painless jaundice, the gall bladder is palpable, then the cause is unlikely to be gallstones.

## Investigations

Depending upon the history and examination, targeted investigations should be performed and include the following:

- FBC to determine Hb and WCC
- LFTs, including transaminases, gamma-glutamyl transpeptidase (GGT), bilirubin, alkaline phosphatase
- all patients who are undergoing active management and treatment require coagulation studies, because of a deficiency of the vitamin K-dependent coagulation factors in jaundiced patients
- a CRP level is useful in patients with evidence of infection to monitor the response to treatment
- other studies, such as viral titres, autoantibody screen, and haemolysis screen, may be indicated in selected patients
- ultrasound is the most important screening radiological investigation, as it can differentiate many aetiologies of jaundice:
  - gallstones
  - demonstrate intra- or extra-hepatic biliary dilatation
  - tumour masses in the region of the pancreas (better seen on CT)
  - liver metastases
  - nodes around the porta hepatis and proximal biliary tree (the lower end of the common bile duct is not well visualized)
- CT scanning is excellent for the assessment of hepatic and pancreatic lesions. A triple-phase scan is indicated to include pre-contrast, arterial and venous phases
- MRI scanning, in the format of MRCP, gives excellent visualization of the biliary tree. With the aid of specific contrast media, the liver is also well delineated. Some units also use MRI preferentially to evaluate pancreatic lesions
- the choice of the initial cross-sectional imaging is down to local preference and expertise. In many cases, CT and MRI are employed
- ERCP is no longer used for diagnostic purposes, but it does have a number of important roles:
  - ERCP is indicated as a therapeutic modality in patients with obstructive jaundice and, in particular, cholangitis. Indeed, cholangitis is an indication for emergency ERCP. The insertion of a stent or the performance of a sphincterotomy allows the drainage of infected

bile. If a patient with malignant obstructive jaundice is deemed not suitable for surgical intervention, a stent may be inserted as a palliative procedure. Metal stents are preferred when there is reasonable life expectancy (>3mo). Stents may also be used if resection is planned, although there is debate as to potential deleterious effects of stenting of the distal bile duct on surgical outcome. Most surgeons prefer opting for surgery and no stent if bilirubin levels are <200 micromoles/L. Plastic stents were traditionally used if surgery was contemplated for lower bile duct obstruction, but metallic stents are not an undue hindrance to surgery and may be preferable if neoadjuvant therapy is planned. For proximal bile duct lesions, drainage of sepsis is critical to outcome, and multiple drains may be required to drain obstructed liver segments. In the case of proximal lesions, metallic stents are not desirable, as they impair the assessment of the tumour

- ERCP allows for the collection and cytological examination of bile and brushings. Biopsies of tissue are also possible
- PTC may be used, in conjunction with ERCP, to insert stents for difficult hilar lesions, such as cholangiocarcinoma (Klatskin's tumour), or extrinsic compression by nodes at the porta hepatis. In rare instances, such as when previous surgery precludes access to the biliary tree or intubation of the ampulla fails, PTC may be the 1° means of inserting a stent and relieving jaundice
- EUS is an important 2° tool in the evaluation of obstructive jaundice, both to evaluate the resectability of known pancreatic head masses and to determine the aetiology of obstructive jaundice in patients without evidence of a mass on cross-sectional imaging. Tissue biopsies may be obtained under direct vision.

#### *Points of caution*

- Generalized intrahepatic duct dilatation is uncommon when there are multiple liver metastases compressing the ducts, when sclerosing cholangitis is present, and when there is liver cirrhosis.
- Any intervention on the biliary tree must be covered with antibiotics, as there is a risk of sepsis. Coagulation must be checked and corrected, as necessary. Occasionally, liver biopsy is appropriate in the jaundiced patient with a suspected malignancy. Liver biopsy of suspected malignant lesions is not advocated if patients are being considered as candidates for surgery because of the risk of tumour dissemination. However, a biopsy of 'normal' parenchyma will provide information on the presence of parenchymal liver disease that may influence the extent of surgery possible. Biopsies can be performed under ultrasound control or laparoscopically.

## Management

The management of the jaundiced patient depends on the aetiology of the jaundice. It is crucial that patients with malignant causes for their biliary obstruction are all discussed in an HPB MDT setting. This ensures they have the best available treatment and also that all cases of malignancy are recorded on the cancer network database. The patient's views, as well as their family's wishes, should be considered, especially when the jaundice is due to recurrence of a previously treated carcinoma.

Each patient with a malignancy should be evaluated for potential resectability by an HPB surgeon sitting as a member of the MDT, since changes in surgical techniques and perioperative outcomes have led to a significant expansion in the indications for surgery in this patient group.

For patients not suitable for resection, palliation may be by means of stenting or surgical bypass. Stenting is currently the preferred option, as this tends to have a lower early morbidity and mortality than a surgical bypass. The main problem with stents is that they can occlude with sludge or tumour growth, with subsequent recurrence of jaundice and sepsis. Metallic stents are less prone to blocking and are inserted when patients have a life expectancy of >3mo, as this is the typical duration of success with a plastic stent.

With advances in laparoscopic surgery, laparoscopic biliary bypass is now technically feasible, and, for the 30% of patients with concurrent gastric outlet obstruction, surgery can deal with both issues.

### *Hepatorenal syndrome*

- Classically, this syndrome occurs in obstructive jaundice, and it is essentially acute oliguric renal failure, occurring without intrinsic renal disease.
- There is intense renal cortical vasoconstriction, with increased renal vascular resistance, decreased GFR, peripheral vasodilatation, and sodium and water retention.
- This diagnosis should be considered in patients with liver dysfunction, obstructive jaundice, rising serum creatinine in the absence of fluid losses, dehydration, renal disease, or nephrotoxic drugs, and in patients who are not septic.
- Investigations should exclude other causes of renal insufficiency—serum and urinary electrolytes, creatinine clearance, blood cultures, urinary tract ultrasound (to exclude urinary obstruction).
- Investigations usually reveal high serum creatinine, low creatinine clearance, low serum sodium, low urinary output, and low urinary sodium.
- Management is complex and should be in the setting of an MDT involving renal physicians. Nephrotoxic drugs should be withdrawn. Sepsis should be corrected. Fluid and electrolyte imbalance should be corrected.
- Selected patients may warrant dialysis with correction of the obstructive jaundice. However, the prognosis is often poor, with only a 3mo survival rate of 20%.
- Discussion with the patient and family, in an MDT setting, with colleagues from the appropriate specialties, is essential for these ill patients with a poor prognosis.

## Further reading

- Agarwal AK, Mandal S, Singh S (2007). Biliary obstruction in gallbladder cancer is not sine qua non of inoperability. *Ann Surg Oncol* **14**, 2831–7.
- Baron JH (2001). Expandable metal stents for the treatment of cancerous obstructions of the gastrointestinal tract. *N Engl J Med* **344**, 1681–917.
- Dubovsky EV, Russell CD (1992). Advances in radionuclide evaluation of urinary tract obstruction. *Abdom Imaging* **23**, 17–26.
- Garden OJ (2007). *Hepatobiliary and pancreatic surgery*. Edinburgh: Elsevier Saunders, pp. 323–30.
- Helyer LK, Lae CHL, Butler M, Last LD, Smith AJ, Wright FC (2007). Surgery as a bridge to palliative chemotherapy in patients with malignant bowel obstruction from colorectal cancer. *Ann Surg Oncol* **14**, 1264–71.
- Hosono S, Ohtani H, Arimoto Y, Kanamiya Y (2007). Endoscopic stenting versus gastroenterotomy for palliation of malignant gastroduodenal obstruction: a meta analysis. *J Gastroenterol* **42**, 283–90.
- Lau MW, Temperley S, Mehta R, Johnson RJ, Barnard RJ, Clarke NW (1995). Urinary tract obstruction and nephrostomy drainage in pelvic malignant disease. *Br J Urol* **76**, 565–9.
- McIntyre JF, Eifel PJ, Levenback C (1995). Ureteral stricture as a late complication of radiotherapy for stage 1B carcinoma of uterine cervix. *Cancer* **75**, 836–43.
- O'Connor DB, Winter DC (2012). The role of laparoscopy in the management of acute small-bowel obstruction: a review of over 2,000 cases. *Surg Endosc* **26**, 12–17.
- Rubin SC (2000). Management of intestinal obstruction in the patient with ovarian cancer. *Oncology* **14**, 1159–63.
- Sohn TA, Lillemoie KD, Cameron JC, Huang JJ, Pitt HA, Yeo CJ (1999). Surgical palliation of unresectable periampullary adenocarcinoma in the 1990s. *J Am Coll Surg* **188**, 658–66.
- Soriano A, Davis MP (2011). Malignant bowel obstruction: individualized treatment near the end of life. *Cleve Clin J Med* **78**, 197–206.
- Taylor MR, Lalani N (2013). Adult small bowel obstruction. *Acad Emerg Med* **20**, 527–44.
- Tilney HS, Lovegrove RE, Purkayastha S, et al. (2007). Comparison of colonic stenting and open surgery for malignant large bowel obstruction. *Surg Endosc* **21**, 225–33.
- Watanapa P, Williamson RCN (1992). Surgical palliation for pancreatic cancer: developments during the past two decades. *Br J Surg* **79**, 8–20.
- Yachia D (1997). Overview: role of stents in urology. *J Endourol* **11**, 379–82.

## Biochemical crises

Malignant hypercalcaemia 732

Hyponatraemia 734

Hyperkalaemia 736

Hyperglycaemia and hypoglycaemia 737

Acute renal failure 738

Tumour lysis syndrome 740

## Malignant hypercalcaemia

*Urgent intervention is required if free  $\text{Ca}^{2+}$  is  $\geq 3.0 \text{ mmol/L}$ .*

- Hypercalcaemia complicates 10–20% of all cancers.
- Occurs in solid tumours and leukaemias.
- Especially associated with breast cancer, myeloma, carcinoma of the lung (especially squamous cell), prostate cancer, and lymphoma.
- Unusual as the presenting feature of malignancy.
- Leads to multi-system dysfunction.
- Effective treatment improves the QoL.

NB Free (ionic)  $\text{Ca}^{2+}$  is dependent on serum albumin and arterial pH.

$$\text{Free (ionic) } \text{Ca}^{2+} \text{ (mmol/L)} \approx \text{measured } \text{Ca}^{2+} \text{ (mmol/L)} \\ + [(40 - \text{albumin}) (\text{g/L}) \times 0.02]$$

### Aetiology

- **Osteolysis**—local increased bone resorption induced by lytic bone metastases. Attributed to the activation of osteoclasts via tumour cell cytokine production (particularly ILs and TNF). Likely to be the dominant mechanism in certain malignancies, e.g. lymphoma, NSCLC. Serum phosphate ( $\text{PO}_4^{3-}$ ) is usually normal.
- **Humoral mediators**—systemic release of factors activating osteoclasts, even in the absence of bony metastases, e.g. PTHrP seen particularly in SCC of the lung. Often associated with  $\downarrow \text{PO}_4^{3-}$  due to the inhibition of  $\text{PO}_4^{3-}$  reabsorption.
- **Dehydration**—exacerbates hypercalcaemia.  $\text{Ca}^{2+}$  is a potent diuretic, causing salt and water loss. As diuresis continues,  $\text{Ca}^{2+}$  levels increase, causing further volume depletion, etc.
- **Tumour-specific mechanisms** (e.g. myeloma)—secretion of an osteoclast-activating factor  $\pm$  deposition of Bence-Jones proteins  $\rightarrow$  renal impairment  $\rightarrow \downarrow \text{Ca}^{2+}$  excretion, e.g. some lymphomas (usually T-cell) produce active metabolites of vitamin D  $\rightarrow \uparrow$  intestinal absorption of  $\text{Ca}^{2+}$ .

Often,  $>1$  mechanism contributes, e.g. in breast cancer, both osteolytic and humoral mechanisms may be important.

### Presentation

- Acute or insidious, or an incidental finding.
- **Neurological**—malaise, fatigue, drowsiness, weakness, depression, cognitive dysfunction, seizures, coma.
- **GI**—nausea, vomiting, anorexia, abdominal pain, constipation, including paralytic ileus, pancreatitis, peptic ulceration.
- **Renal**—polydipsia, polyuria, dehydration, signs of uraemia, renal colic ( $2^\circ$  to renal calculi).
- **Cardiac**—arrhythmias,  $\uparrow$  or  $\downarrow$  BP, or postural hypotension.



## Investigations

- U & Es, corrected serum  $\text{Ca}^{2+}$ ,  $\text{PO}_4^{3-}$ , magnesium ( $\text{Mg}^{2+}$ ), LFTs, amylase.
- FBC—a normal Hb will fall, once the patient is rehydrated.
- Plasma PTH—this is appropriately undetectable in malignant hypercalcaemia. Remember non-malignant causes of hypercalcaemia are common and may coexist with a diagnosis of cancer, e.g. 1° or tertiary hyperparathyroidism, hyperthyroidism.
- ECG—may be abnormal, including ↑ PR interval, ↓ QT, wide QRS.

## Management

- Intervention likely to improve symptoms in all patients, other than those entering the last few hours of life.
- *Rehydration is the priority*—to produce volume expansion, restore glomerular function and increase urinary  $\text{Ca}^{2+}$  excretion. Fluid deficit may be many litres. Aim for 3–6L/24h if the cardiac function and urine output permit. Use 0.9% saline, and reassess the fluid status regularly.
- *Monitor U & Es*—renal impairment should improve with fluid resuscitation. Potassium ( $\text{K}^+$ ) and  $\text{Mg}^{2+}$  may fall with rehydration and require IV replacement ( $\text{K}^+$  20–40mmol/L and  $\text{Mg}^{2+}$  up to 2mmol/L of normal saline). Check  $\text{Ca}^{2+}$  and albumin daily.
- *Bisphosphonates*—consider if  $\text{Ca}^{2+}$  remains  $\geq 3.0$ mmol/L, despite rehydration. Cause inhibition of osteoclast activity → ↓  $\text{Ca}^{2+}$ . Typical schedule—pamidronate 60–90mg, infused in 1L of normal saline over 2–24h, provided renal function adequate following 24h of rehydration. Then, continue fluids. Onset of action from 48h, and usually normocalcaemic within 3–7 days; hence, fluid resuscitation is the critical step in acute management. Cannot repeat the dose for 7 days. The optimal interval is  $\geq 3$ wk (avoid repeating within a week). Side effects—transient fever, hypocalcaemia. Zoledronic acid (4mg IV over 15min) is superseding pamidronate disodium as the bisphosphonate of choice in malignant hypercalcaemia, due to its shorter infusion time and greater potency.
- *Loop diuretics*—e.g. furosemide PO/IV, ↓  $\text{Ca}^{2+}$  (↓ reabsorption in the loop of Henle), maintains diuresis once patient rehydrated.
- *Steroids*—little role. May be helpful in haematological malignancies such as myeloma (e.g. prednisolone 30–60mg od).
- *Avoid immobility*—lack of weight-bearing induces increased osteoclastic activity, whilst reducing bone formation.
- *Dietary  $\text{Ca}^{2+}$  restriction*—not appropriate; gut  $\text{Ca}^{2+}$  absorption usually decreases appropriately. Rare exception—some patients with lymphoma associated with ↑ vitamin D metabolites.
- *Salmon calcitonin*—→ ↑ renal  $\text{Ca}^{2+}$  excretion and ↓ bone reabsorption. IM or s/c administration. Efficacy limited to initial 48h of treatment (tachyphylaxis). Very uncommonly used.
- *Treat the underlying malignancy*—if appropriate. Hypercalcaemia is usually associated with advanced disease. Palliative systemic therapy or radiotherapy for symptomatic bony lesions may improve the QoL.

# Hyponatraemia

## Aetiology

*With low plasma osmolality*

*With normal or increased plasma volume*

- Excess ADH:
  - *ectopic tumour production of ADH*—most commonly associated with SCLC. Also described in many other cancers, including carcinoid tumours, lymphomas, leukaemias, and pancreatic cancer
  - *SIADH*—reducing excretion of ingested  $H_2O$   $\pm$  re-setting of the osmostat (maintaining serum  $Na^+$  at a stable lower level). Multiple causes, including major surgery, pulmonary disease (e.g. concurrent pneumonia), and raised ICP. Apparent idiopathic SIADH is often associated with occult malignancy, particularly SCLC
  - *stimulation of ADH secretion*—can be caused by drugs used in the treatment of cancer, e.g. ifosfamide, vincristine, high-dose IV cyclophosphamide, opioids.
- *Metabolic causes, including glucocorticoid insufficiency*—e.g. following the rapid withdrawal of long-term exogenous steroid (may be accompanied by  $\uparrow K^+$   $\pm$  metabolic acidosis) or hypothyroidism.
- *Excess IV fluid replacement*—with hypotonic fluids or 1° polydipsia.
- *Organ failure*—including renal failure, congestive cardiac failure, hepatic cirrhosis with ascites.

*With reduced plasma volume*

- $\uparrow$  *renal  $Na^+$  loss*—e.g. nephropathy following cisplatin chemotherapy, Addison's (mineralocorticoid deficiency), renal tubular acidosis.
- $\uparrow$  *non-renal  $Na^+$  loss*—e.g. diarrhoea and vomiting, repeated ascitic drainage.

*With normal or high plasma osmolality (pseudohyponatraemia)*

For example, 2° to hyperglycaemia, very elevated serum paraproteins, or retention of hypertonic mannitol used in pre-hydration regimens for chemotherapy—this produces high plasma osmolality, drawing intracellular water out into the circulating volume, and hence producing apparent hyponatraemia. There is no hypo-osmolality, therefore no osmotic movement of water into the brain and hence no risk of cerebral oedema. Treatment directed at correcting the serum  $Na^+$  is therefore not indicated.

## Presentation

Often asymptomatic. Presence of symptoms dependent on:

- the degree of hyponatraemia ( $\uparrow$  symptoms if  $Na^+ < 125$  mmol/L)
- the rapidity of onset
- the age and sex of the patient—pre-menopausal women most at risk.

If unwell, symptoms tend to be primarily neurological:

- nausea, malaise, and weakness
- confusion, headache, and drowsiness
- seizures, coma, and respiratory arrest.

## Examination and investigations

- Assess the hydration status. May appear dehydrated ( $\downarrow$  skin turgor, postural hypotension, tachycardia) or hypervolaemic (oedematous, ascites, etc.), depending on the aetiology.
- Plasma and urinary  $\text{Na}^+$ .
- Plasma and urinary osmolality.
- LFTs, glucose, amylase, TFTs.
- Cortisol  $\pm$  short tetracosactide test, if adrenal failure suspected.
- SIADH—low serum  $\text{Na}^+$  and osmolality with inappropriately normal/high urinary  $\text{Na}^+$  and osmolality in a euvolaemic patient with normal adrenal, renal, and thyroid function.

## Management

### With normal or increased plasma volume

- *Fluid restriction*—to  $\sim 0.5\text{--}1\text{L/day}$  (i.e. to below the level of urine output) is often sufficient, particularly in asymptomatic patients with serum  $\text{Na}^+ > 125\text{mmol/L}$ .
- *Optimize the remaining electrolytes.*
- *Inhibition of the action of ADH on the renal tubule*—e.g. with demeclocycline (e.g.  $300\text{mg PO tds}$ ) to increase water excretion. Only consider in occasional patients with persistent significant hyponatraemia who cannot tolerate water restriction. The renal function needs to be monitored.
- *Infusion of hypertonic (3%) saline*—only to be considered if hyponatraemia is life-threatening, and then only under senior or specialist supervision. Overly rapid correction must be avoided, particularly in chronic hyponatraemia. Not appropriate in most malignant causes of hyponatraemia, as  $\text{Na}^+$  handling is intact in SIADH. Administered  $\text{Na}^+$  will simply be excreted, unless the osmolality of the administered fluid exceeds the urine osmolality.

### With reduced plasma volume

- IV infusion of normal (0.9%) saline, with close monitoring of the plasma volume.

## Further reading

Verbalis JG, Goldsmith SR, Greenberg A, Schrier RW, Sterns RH (2007). Hyponatraemia treatment guidelines 2007: expert panel recommendations. *Am J Med* 120 (11 Suppl 1), S1–21.

## Hyperkalaemia

### Aetiology

- *Renal failure*—probably the most frequent cause.
- *Tumour lysis syndrome*—usually following the initiation of therapy for large-volume treatment-sensitive disease (see  Tumour lysis syndrome, p. 740) or occasionally due to spontaneous tumour cell necrosis.
- *Concurrent septicaemia*.
- *Adrenal insufficiency*—usually 2° to glucocorticoid withdrawal or, rarely, adrenal destruction by a tumour.
- *Acute graft-versus-host disease*—following allogeneic bone marrow transplantation.
- *Drugs*—e.g. diuretics such as spironolactone.

### Presentation

- Often asymptomatic.
- Occasionally muscle cramps/weakness.
- Cardiac dysrhythmias and arrest.
- Signs and symptoms of underlying cause.

### Management

- *12-lead ECG and continuous cardiac monitoring*—effects of  $\uparrow K^+$  on cardiac conducting tissue include tented T-waves, broadening of the QRS complex, flattened P-waves, and heart blocks.
- *Establish IV access, and give 10mL of 10% calcium gluconate IV*—this is cardioprotective. Can be repeated every 10min, until the ECG normalizes (up to 50mL may be required).
- *50mL of 50% glucose with 10 units of soluble insulin, infused over 15–30min* ( $\uparrow$  movement of  $K^+$  into cells).
- *5mg of nebulized salbutamol*.
- *Polystyrene sulfonate resin enema (Calcium Resonium®)*—increases gut  $K^+$  losses.
- *If associated renal failure*—consider IV rehydration, need for central access, and possibly IV sodium bicarbonate to correct acidosis (e.g. 50–100mL of 8.4% bicarbonate IV over 30min via a central line). This usually requires senior or specialist supervision.
- *Haemodialysis*—occasionally necessary.

## Hyperglycaemia and hypoglycaemia

- *Corticosteroid administration*—corticosteroids are used in the treatment of some malignancies and as part of the routine anti-emetic prescription in highly and moderately emetogenic chemotherapy regimes. Will increase insulin requirements in patients with diabetes mellitus and may precipitate the need for hypoglycaemic medication in those with (often previously unidentified) impaired glucose tolerance.
- *Loss of appetite, nausea, and vomiting*—may complicate the management of blood sugars in the diabetic patient.
- *Inappropriate insulin production*—from islet cell tumours and pancreatic APUDomas (amine precursor uptake and decarboxylation). Large metastatic tumours, particularly in the liver, rarely can produce IGFs which are released into the circulation, especially in response to treatment.

## Acute renal failure

Certain causes of acute renal failure (ARF) may be seen more commonly in the patient with malignant disease. Identification of treatable causes is the priority. Causes can be divided into the following categories, although frequently renal impairment is multifactorial:

- *pre-renal*—hypovolaemia due to, e.g. dehydration due to vomiting or hypercalcaemia, haemorrhage, concomitant sepsis causing impaired renal perfusion
- *renal*—renal parenchymal damage due to cytotoxic agents, e.g. platinum-based chemotherapy, and other nephrotoxic drugs, e.g. non-steroidal anti-inflammatory analgesia; tumour lysis syndrome (calcium phosphate crystals) or myeloma (Bence–Jones proteins) causing deposition within the tubules; glomerulonephritis 2° to underlying malignancy
- *post-renal*—e.g. obstruction 2° to a pelvic tumour, retroperitoneal fibrosis, or pathological lymphadenopathy; renal vein thrombosis.

### Presentation

- Nausea/vomiting, anorexia, lethargy.
- Oliguria/anuria.
- Fluid overload (peripheral/pulmonary oedema, ↑ jugular venous pressure (JVP), or volume depletion if pre-renal aetiology is dominant)—↓ skin turgor, postural hypotension, dry mucous membranes.
- Confusion or seizures.
- Symptoms related to specific electrolyte abnormalities observed due to renal tubular dysfunction, e.g. ↓ Ca<sup>2+</sup>, ↓ Mg<sup>2+</sup>, ↓ K<sup>+</sup>, ↓ Na<sup>+</sup> → perioral/limb dysaesthesiae, tetany/carpopedal spasm, muscle weakness, arrhythmias, etc. Patients receiving certain chemotherapy drugs, e.g. cisplatin, ifosfamide, are at particular risk of renal tubular dysfunction and require close monitoring of renal function and electrolyte levels.

### Investigations

- U & Es, LFTs, Ca<sup>2+</sup>, Mg<sup>2+</sup>, PO<sub>4</sub><sup>3-</sup>, bicarbonate, FBC.
- ABGs—establish the degree of metabolic acidosis.
- CXR—fluid overload, the underlying diagnosis.
- Urinalysis—haematuria, proteinuria, crystals, casts, pus cells, Bence–Jones protein.
- ECG—signs of ↑ K<sup>+</sup> (see ↻ Hyperkalaemia, p. 736).
- Investigations for underlying causes—may include septic screen, vasculitic screen, renal USS Doppler imaging to assess blood flow, IVU, and renal biopsy. CT abdo/pelvis may identify filling defects consistent with an IVC thrombus and establish the extent of malignant disease.

## Management

Appropriate management may include:

- *resuscitation*—correction of life-threatening electrolyte derangement (see other sections in this chapter) and establishment of euvolaemia, if possible
- *monitoring*—urine output (usually requiring catheterization). Cardiac monitor until electrolytes within the normal range. Consider CVP monitoring
- *treat the underlying causes, if possible*—this should include treatment of suspected infection and review of all potentially nephrotoxic drugs:
  - *pre-renal*—aggressive fluid replacement to optimize renal perfusion and minimize ischaemic injury. Requires frequent assessment for volume overload and prompt involvement of the renal team, if oliguria persists despite euvolaemia
  - *post-renal*—bladder catheterization (per urethra or suprapubic) to relieve the obstruction of the lower urinary tract. Retrograde ureteric stenting or percutaneous nephrostomy placement for drainage of the upper urinary tract. Diuresis may follow the relief of obstruction
- *dialysis/haemofiltration*—indicated in refractory hyperkalaemia, fluid overload, or symptomatic uraemia (e.g. encephalopathy). Early involvement of the renal team.

Management of these patients is likely to require discussion with senior colleagues. Information regarding 1° cancer diagnosis and stage, realistic assessment of future treatment options, anticipated prognosis, and quality of life are all likely to have a bearing on decisions made. If treatment options for the underlying malignancy are limited, aggressive intervention for their renal failure is likely to be inappropriate.

If uraemia is present at the end of life, then minimally invasive nursing and symptomatic management should be the focus of care:

- nausea (e.g. haloperidol, cyclizine)
- itching (e.g. topical emollients)
- myoclonic jerks (e.g. low-dose benzodiazepines).

## Tumour lysis syndrome

### Aetiology

- A syndrome of metabolic abnormalities and renal impairment, due to massive lysis of rapidly proliferating tumour cells, resulting in the release of intracellular contents into the circulation.
- Suspect in patients with large-volume malignant disease developing ARF, in the presence of hyperuricaemia and/or hyperphosphataemia.
- Most commonly associated with bulky chemosensitive disease, e.g. poorly differentiated lymphomas, leukaemias with high blast count, metastatic germ cell tumours.
- Also described in many other cancers, e.g. breast, myeloma.
- Onset usually within hours or days of commencing chemotherapy.
- Can also occur:
  - after steroid monotherapy—e.g. in lymphoma or lymphoblastic leukaemia
  - following radiotherapy—for a similar range of cancers
  - spontaneously—in tumours with high cell turnover (typically without hyperphosphataemia).

### Metabolic abnormalities

- *Hyperuricaemia*—release of nucleic acids metabolized to uric acid. Relative insolubility in water results in crystal deposition in renal tubules → acute uric acid nephropathy and oliguric ARF.
- *Hyperphosphataemia*—2° to the release of intracellular phosphate. Malignant cells have significantly higher concentrations of phosphate than normal tissues. Can precipitate with calcium, causing the deposition of calcium phosphate, e.g. in renal tubules (→ ARF), the skin (→ gangrene), and the heart (→ arrhythmias).
- *Hyperkalaemia*—exacerbated by deteriorating renal function. Can cause cardiac arrhythmias.
- *Hypocalcaemia/hypomagnesaemia*—2° to ↑  $\text{PO}_4^{3-}$  and the precipitation of calcium phosphate. Symptoms include muscle weakness ± tetany. Contributes to cardiac dysrhythmias.
- *Acute renal failure*—due to urate crystal deposition and/or ↑  $\text{PO}_4^{3-}$ . May be exacerbated by an underlying renal dysfunction due to, e.g. a tumour mass causing obstructive nephropathy or malignant infiltration of the renal parenchyma.
- *Metabolic acidosis*.

### Prophylaxis

- **PREVENTION IS THE PRIORITY.**
- *Identify patients at risk:*
  - patient-specific—baseline metabolic abnormality, e.g. hyperuricaemia. Suboptimal renal function, e.g. dehydration, obstructive nephropathy
  - tumour-specific—large-volume disease, rapid cell turnover, anticipated chemosensitivity
  - most commonly affected tumour types—high-grade lymphomas, leukaemias with high peripheral blast count, some germ cell tumours.



- Optimize renal function before and during treatment—relieve the urinary tract obstruction, if possible. Correct electrolyte abnormalities, e.g. hypercalcaemia. Ensure adequate fluid replacement. This usually involves IV hyperhydration to maintain a high urine output (ideally 100mL/h). The osmotic diuretic mannitol is sometimes used in pre-treatment hydration regimes. Loop diuretics (e.g. furosemide) can also help maintain appropriate diuresis during therapy.
- If low risk (absence of pre-treatment hyperuricaemia)—allopurinol, a xanthine analogue → competitive inhibition of xanthine oxidase → reduces the metabolism of xanthine and hypoxanthine to uric acid, e.g. 300mg PO od. Pre-treatment for 48h prior to chemotherapy results in a marked decrease in the incidence of post-treatment hyperuricaemia.
- If high risk (pre-treatment hyperuricaemia)—rasburicase; the administration of a recombinant urate oxidase causes ↑ degradation of uric acid to more water-soluble catabolites, e.g. 200 micrograms/kg od—the duration of treatment dependent on the serum uric acid level, usually 1–7 days. Contraindicated in glucose-6-phosphate dehydrogenase (G6PD) deficiency.
- Leucophoresis—if peripheral blast count high.
- Urinary alkalinization—no good evidence.

The Cairo–Bishop definition of tumour lysis syndrome is  $\geq 2$  abnormal serum biochemistry results (see Table 36.1) occurring from 3 days prior to treatment until 7 days after commencing treatment.

## Symptoms

- Reflect the underlying metabolic derangement.
- GI—anorexia, nausea, vomiting, diarrhoea.
- Neurological—lethargy, paraesthesiae, confusion, seizures, hallucinations, coma.
- Musculoskeletal—muscle cramps or tetany.
- Renal—flank pain, haematuria, oliguria/anuria, oedema.
- Cardiac—heart failure, syncope, arrhythmias, sudden death.

**Table 36.1** Cairo–Bishop definition of laboratory tumour lysis syndrome

Metabolite	Value	Compared to baseline
Uric acid	$\geq 476$ micromoles/L	25% ↑
K <sup>+</sup>	$\geq 6$ mmol/L	25% ↑
PO <sub>4</sub> <sup>3-</sup>	$\geq 1.45$ mmol/L (adults)	25% ↑
Ca <sup>2+</sup>	$\leq 1.75$ mmol/L	25% ↓

### Management

- Urgent correction of hyperkalaemia (see ➔ Hyperkalaemia, p. 736).
- Monitor fluid balance—urinary catheterization may be helpful. Careful assessment of the circulating volume and IV rehydration, if volume-depleted.
- Urinalysis—may demonstrate uric acid crystals but may be normal due to oliguria from obstructed nephrons.
- Exclude post-renal causes of renal failure with USS, e.g. ureteric obstruction. Suspect this, particularly if there is flank pain.
- Monitor electrolytes and urate—at least twice daily until stable. Patients receiving rasburicase require serum uric acid to be transported on ice directly for analysis.
- Calcium supplementation not usually necessary, unless there is neuromuscular irritability.
- Consider alkalinizing the urine—e.g. with acetazolamide or sodium bicarbonate. This reduces uric acid precipitation by converting uric acid to the more soluble urate salt. Evidence is controversial, and hospital policies may vary. Likely to require senior or specialist supervision.
- Assess the need for haemodialysis to remove excess circulating uric acid—consider referral if metabolic derangement persists, despite appropriate care, ongoing metabolic acidosis, oliguria, or symptomatic uraemia, despite rehydration and diuretics. Early dialysis is associated with a high chance of complete recovery of the renal function.

### Further reading

- Cairo MS, Bishop M (2004). Tumour lysis syndrome: new therapeutic strategies and classification. *Br J Haematol* **127**, 3–11.
- Coiffer B, Althman A, Pui C-H, Younes A, Cairo MS (2008). Guidelines for the management of pediatric and adult tumor lysis syndrome: an evidence-based review. *J Clin Oncol* **26**, 2767–78.

# Complications of long-term central venous lines and chemotherapy extravasation

Complications of long-term central venous lines 744

Chemotherapy extravasation 746

## Complications of long-term central venous lines

Cancer patients commonly require IV therapy over a period of many months. This may be in the form of regular infusions in hospital or as a continuous portable infusion at home. Vascular access may be difficult in this group of patients, due to either their 1° diagnosis or complications of their treatment, e.g. lymphoedema, previous radiotherapy, etc.

An alternative to frequent (and often painful) peripheral cannulation is the insertion of a long-term venous catheter terminating in the proximal SVC. This is most commonly a tunnelled catheter (e.g. Hickman, Groshong) passing via the subclavian vein and exiting the skin at the chest wall, with a Dacron 'cuff' to secure it just inside the exit site. Alternatives include a totally implantable device, also tunnelled beneath the chest skin, but with an s/c infusion reservoir accessed by needle puncture (e.g. Port-a-cath) or a peripherally inserted central catheter (PICC) exiting in the antecubital fossa.

### Infection of central venous lines

#### Local

- Presenting with purulent discharge from the exit site, local pain, and erythema  $\pm$  tenderness overlying the s/c tunnel tract.  
*Beware*—immunocompromised patients may demonstrate few signs of local infection until bone marrow recovery.
- Optimal management is with removal of the line. However, antibiotic therapy without removal of the line is a reasonable approach, if the line is still needed for therapy and provided the patient is monitored for any signs of systemic infection.
- Flucloxacillin 500mg qds PO for at least a week (unless penicillin-allergic), pending results from swabs/cultures, is an appropriate starting regime in a well patient, although local guidelines should be consulted.

#### Systemic

- Presenting with signs and symptoms of systemic sepsis, often including pyrexia, rigors, and hypotension. Signs of local catheter infection may also be present. Rarely, there may be distant complications such as metastatic abscesses or endocarditis.
- Confirmation of the diagnosis is by isolation of the same microorganism from blood cultures taken from the catheter and from peripheral samples, without the identification of an alternative source.
- Resuscitation and empiric antibiotic treatment must commence immediately. Again, local protocols should be consulted. However, an example of an appropriate regime, pending sensitivities, would be vancomycin, in combination with an aminoglycoside, e.g. gentamicin, with dosing dependent on the renal function and serum levels.
- Line removal is optimal—the tip should be sent for culture. However, in an uncomplicated bacteraemia with a line still functioning, antibiotic therapy alone may be reasonable. Antibiotics should be administered down the line, and the patient should be monitored closely. Seek advice from microbiology, once sensitivities are known regarding changing therapy and the ideal duration of treatment.

- Line removal becomes imperative in certain situations, including failure to improve within 48h, suspicion of infection with fungi or Gram-negative bacilli, especially *Pseudomonas aeruginosa*, septic thrombophlebitis, metastatic abscesses, and endocarditis.

### Thrombosis of central venous lines

Thrombus related to long-term venous catheterization of patients with cancer is relatively common, e.g. studies suggest a 3–30% incidence of catheter-induced axillo-subclavian vein thrombosis. This is a population already prone to thrombosis, in which a thrombogenic focus has been introduced.

#### Presentation

- Commonly asymptomatic—high index of suspicion needed.
- Local symptoms, e.g. unilateral hand/arm oedema, shoulder pain, prominent collateral veins visible on the chest wall.
- Distant embolization.

#### Investigation

- Usually by duplex ultrasound examination.
- Occasionally with a venogram. However, this requires adequate peripheral access, the absence of which is often the reason the catheter was inserted in the first place.

#### Management

- *Line removal*—if at all possible, i.e. removal of the thrombogenic stimulus. Commonly, this is a decision that potentially complicates the treatment of the underlying cancer and therefore needs to be addressed on an individual basis.
- *Anticoagulation*—with low-molecular-weight heparin or warfarin. The duration of anticoagulant therapy is dependent on the past medical history, the ongoing presence of the venous catheter, other risk factors, etc.
- *Catheter-directed thrombolysis*—there is no current evidence that this is superior to conservative management. However, it can be considered in selected patients, particularly those with a good prognosis from their cancer who have significant acute thrombus-related symptoms.

#### Prophylaxis

Warfarin, 1mg od, without routine INR monitoring is a commonly used prophylactic regime in cancer patients with long-term venous catheters. There are randomized prospective double-blind data to support this as a method for reducing the incidence of catheter-related thrombus in patients receiving chemotherapy. It is generally well tolerated, with a low complication rate. However, it should be remembered that, even at this low dose, warfarin may prolong the INR to potentially dangerous levels—for instance, with concomitant broad-spectrum antibiotic therapy or with certain chemotherapy regimes, e.g. those containing fluorouracil.

#### Thrombus of the catheter lumen

The inability to withdraw blood from, or infuse into, a venous catheter is common. The CXR will help exclude kinking or line migration. Instillation of a fibrinolytic agent into the line, e.g. urokinase or equivalent, may clear the intraluminal thrombus.

## Chemotherapy extravasation

Many chemotherapy drugs are rather poorly soluble in aqueous media and are vesicant (literally causing a drying effect—tissue necrosis) to tissues. Great care must be taken to ensure that drugs are given into a free-flowing vascular access. This can be done by ensuring that IV fluids (usually normal saline) run in without restriction, resistance, or local pain. This is particularly important to check if patients have lines that have been *in situ* for many days. If any doubt exists about the patency, the venous catheter should not be used. A new venous access should be obtained and checked for patency. Despite these precautions, extravasation of drugs will still occur in rare cases. Some drugs are less likely to cause tissue problems (e.g. fluorouracil) than others. Some agents can cause extensive tissue damage that requires debridement, and even subsequent tissue grafting. Particular care should be exercised with anthracyclines and vinca alkaloids. Local protocols exist in cancer centres for the management of extravasation.

For all IV drugs:

- stop the infusion if pain at injection site
- frequently test the patency of the IV device by allowing blood flow back and free flow of an IV solution, such as saline, if delivering IV bolus drugs
- avoid unattended infusions of known highly vesicant drugs such as doxorubicin or vincristine
- if extravasation suspected, immediately stop the infusion
- massage the tissue to extrude any obvious fluid from the IV site.

Controversy exists as to the use of ice packs, needle aspiration of tissues, and/or the use of hyaluronidase to cause the diffusion of substances away from the injection site. Follow the local policies, if available.

Early involvement of plastic surgery is advisable in all patients who have significant tissue injury.

### Further reading

- Acedo Sanchez JD, Battle JF, Feijoo JB (2007). Catheter-related thrombosis: a critical review. *Support Cancer Ther* 4, 145–51.
- Zingg W, Cartier-Fassler V, Walder B (2008). Central venous catheter-associated infections. *Best Pract Res Clin Anaesthesiol* 22, 407–21.

## Part 6

# The way forward

38	Novel therapeutic strategies	749
39	Gene therapy and genetic immunotherapy for cancer	759
40	Biomarkers and cancer	773





# Novel therapeutic strategies

- New drug discovery 750
- Novel radiotherapeutic approaches 754
- Targeted radiotherapy 756
- Combined modalities 758

## New drug discovery

The process of drug discovery is driven by three main factors:

- conventional therapies have reached a plateau of effectiveness and therapeutic index
- opportunities for novel molecular targets opened up by our new understanding of the molecular biology of cancer
- the range of new technologies that are available allow for the rapid-throughput testing of many thousands of potential drug compounds.

### Contemporary approaches to drug discovery

The increasing trend is for a given drug discovery project to be aimed at a particular molecular target (e.g. a specific oncogene product), the hope being that pharmacological intervention might deliver a particular desired biological or phenotypic effect (e.g. inhibition of proliferation, cell cycle progression, motility, invasion, angiogenesis, and metastasis; or the induction of apoptosis or differentiation), rather than a more general cytotoxic or cytostatic effect.

This molecular target-orientated approach is now dominant in the pharmaceutical and biotechnology companies. Contemporary mechanism-based drug discovery can be divided into the following phases (see Fig. 38.1).

#### *Target identification and validation*

The objective is to identify genes and their associated proteins that are directly responsible for cancer causation and progression. Having identified a gene that is either mutated or shows deregulated expression, a variety of experiments can be carried out to validate the target—i.e. to provide evidence that it is indeed involved in the disease process in humans and to increase the level of confidence that pharmacological manipulations of the target would lead to an anti-tumour effect.

#### *Lead identification*

The objective of this phase is to identify a chemical structure that has some activity against the molecular target. This may be done by screening chemically diverse compounds in automated high-throughput assays or by a rational design, based on a known substrate or ligand. Much of this part can now be done *in silico* by exploration of public access databases.

#### *Lead optimization*

The aim is to improve and refine the desired properties of the lead (e.g. solubility, potency, and selectivity) and eliminate undesirable features. This is done by making chemical derivatives or analogues of the lead compound.

#### *In vivo testing*

The final stage of testing will involve seeking evidence of regression or growth arrest/delay in a human tumour xenograft. Depending on the biological effect sought, more complex tests, such as orthotopic or metastatic models, may be useful. Transgenic mouse models can be valuable, as can surrogate non-tumour endpoints.

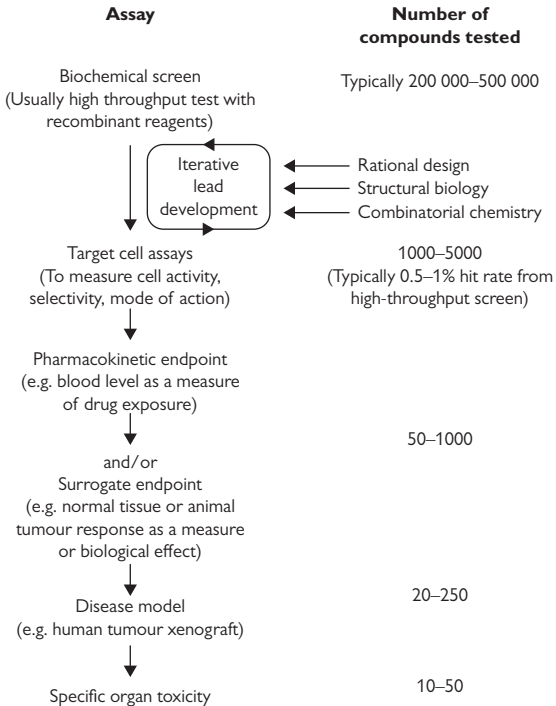

Fig. 38.1 Structure of a contemporary mechanism-based drug discovery test cascade.

Usually, activity will be sought in at least a small panel of tumours, including human xenografts. Ideally, these would be characterized for the molecular target and pathway involved, together with any other relevant features.

There is an increasing use of so-called transgenic models which are considered to be more representative of the human disease than older xenograft models.

#### *Preclinical drug development*

Following the selection of a potential clinical candidate, a number of preclinical development activities must be carried out:

- formulation—the choice of formulation is influenced by solubility, stability, and dosage requirements
- preclinical pharmacology—more detailed pharmacokinetic/absorption, distribution, metabolism, excretion (ADME) studies will be carried out
- preclinical toxicology—to define qualitative and quantitative organ toxicities.

## Conclusion

Despite major advances in the methodology, the drug discovery and development process is still likely to take around 10y from new target to regulatory approval. With the trend away from empirical screening for anti-cancer activity to new mechanism-based approaches targeted to specific molecular abnormalities responsible for cancer, we are now screening a range of exciting new agents emerging for clinical evaluation.

The explosion of molecular knowledge about cancer pathophysiology is now beginning to yield new agents that strike at specific target pathways that are expressed within the cancer.

## Clinical trials

The 1° aim of phase I trials is to establish the safety and tolerability of the compound being tested and to define an optimum dose and schedule for further (phase II) studies. Other 2° objectives may be to investigate the pharmacokinetics of the drug in humans and study the efficacy of the drug in the patients. Also see Chapter 10.

### Phase I

Phase I studies are generally dose escalation trials where the initial dose level is calculated from the preclinical toxicology studies. This starting dose aims to be low enough to ensure the safety of the patients, but high enough to minimize the number of patients treated at ineffective (too low) doses.

The endpoint of the phase I trial is normally toxicity (the MTD and DLT will be defined in the protocol), except for non-cytotoxic agents when the endpoint may be the optimum activity of the drug, as defined by its mechanism of action, unless unacceptable toxicity is observed first. For example, this may be the inhibition of an enzyme or the reduction of the plasma levels of a hormone.

On completion of the phase I trial, the basic toxicity profile of the agent in question should be known and an appropriate dose for further trials identified.

It is still unusual in oncology for phase I studies to be done in normal volunteers—but, in certain circumstances with drugs in which we can monitor a biological effect, this does now occur.

### Phases II and III

Unless the drug has proved to be unacceptably toxic, it will then be subject to phase II and, if successful, phase III testing. The aim of phase II trials is to assess the efficacy of the drug. Each phase II trial will be undertaken in patients with one particular tumour type, and they will all be treated with the same dose and schedule. Whilst toxicity will continue to be monitored, the patients' disease will also be assessed for response.

There is a trend to perform randomized phase II trials in oncology of intermediate size, between the traditional 30–40 patient phase II and the much bigger full-scale phase III RCT. Usually, this is done to give an earlier indication of whether the novel agent actually does hit the target that was intended or to allow for the introduction of patient selection criteria that could enrich the trial population, in order to maximize that chance that the drug will have demonstrable anti-cancer activity.

The aim of phase III trials is to compare the new agent with existing best treatment for the disease in question.



## Novel radiotherapeutic approaches

Radiotherapy is an effective anti-cancer treatment modality. Increasing the dose delivered to the tumour, whilst sparing the surrounding normal tissue, will commonly improve local tumour control. Novel radiotherapeutic approaches aim to:

- increase the dose delivered to the tumour
- more accurately localize that radiotherapy onto the cancer
- increase the biological effectiveness of radiation by the use of radiosensitization agents
- use different forms of radiation that have improved biological effects
- use alternative schedules of radiation to increase the differential between tumour kill and normal tissue damage.

### Targeted radiotherapy

The biological properties of the tumour itself provide the basis for selective irradiation. In principle, this strategy should be capable of eradicating tumour cells anywhere in the body, but it is currently at an early stage of development for many sites.

- Iodine (well-differentiated thyroid carcinomas).
- mAbs to cancer cell surface antigens (B-cell lymphoma).
- The catecholamine precursor analogue MIBG (neuroblastoma).
- Somatostatin (neuroendocrine tumours).

### Improvements in external beam radiotherapy delivery

Improvements in focusing the external radiotherapy beam on the tumour and avoiding normal tissue should allow a safe increase in the dose of radiotherapy delivered. The principle is similar to stereotactic surgery—in fact, the so-called  $\gamma$ -knife has been developed with a focus on the use in CNS tumours to avoid radiotherapy to nearby vital structures.

#### *Conformal therapy*

This technique uses 3D image reconstruction and treatment planning to conform a high dose of radiotherapy to the target volume (often irregularly shaped) but maintain a low dose to the non-target tissues of the patients. Early clinical results suggest that normal tissue side effects can be reduced, and dose escalation is possible, e.g. in the treatment of localized prostate cancer.

#### *Intensity-modulated radiation therapy*

Here, the intensity of the radiotherapy beam is varied across the treatment field to ensure that a uniform dose can be achieved in a regular- or irregular-shaped target. Essentially, this may add to conformal therapy by further reducing the dose to sensitive structures.

#### *Intraoperative radiotherapy*

Radiotherapy can be delivered to a tumour volume under direct visual localization during an open operation within a designated radiotherapy suite. A large single dose is delivered at the one procedure. The potential advantage of a targeted boost (given in addition to external beam fractionated therapy) is balanced by the theoretical limitations of the biological effects of the single large dose.

## Improvements in radiotherapy fractionation

In general, tumours and critical normal tissues (those that limit the dose that may safely be delivered in a course of radiotherapy) are associated with different fractionation sensitivities.

Studies have demonstrated fast rates of growth in certain tumours, such that clonogens have potential doubling times of <5 days. This implies that the time taken to deliver a radical course of conventionally fractionated radiotherapy should not be extended. Indeed, clinical trials have demonstrated benefits with treatment acceleration where a radical course of treatment may be completed in 2wk (with thrice-daily fractions), rather than the more usual 4–6wk.

## Radiosensitization

If tumour cells can be made more sensitive to the delivered radiotherapy, improvements in local control can be gained only if radiosensitization is selective for the tumour.

### *Hypoxic cell sensitizers*

Hypoxic tumour cells are resistant to radiation. The delivery of hypoxic cell sensitizers should theoretically improve tumour cell kill. Recently, trials, with, e.g. tirapazamine, have demonstrated benefit, but these agents are still under evaluation.

### *Synchronous chemotherapy*

Chemotherapy delivered with radiotherapy may provide benefit over and above the addition of more cell kill. This may be due to the inhibition of DNA repair by the agent or some other mechanism of tumour radiosensitization. More clinical studies are required to define the optimal combination of chemotherapy and radiotherapy and to ensure that this is a selective improvement for the tumour and does not just produce additive toxicity. However, the approach is widely used in some cancers, e.g. rectal cancer which is locally advanced.

## Targeted radiotherapy

Targeted radiotherapy means the selective irradiation of tumour cells by radionuclides that are conjugated to tumour-seeking molecules (targeting agents).

### Targeting agents

Tumour targeting depends on the existence of biological differences between normal and tumour cells. Several categories of targeting agents have been used or are under development (see Table 38.1).

- mAbs:
  - limited discriminatory ability
  - poor penetration of tumour mass
  - murine antibodies provoke a host response
  - used in cancer of ovary, colon, and brain, with modest response
  - best response in B-cell lymphoma.
- MIBG:
  - taken up by catecholamine-synthesizing cells of the sympathetic nervous system
  - taken up by neuroblastoma, phaeochromocytoma
  - diagnostic and therapeutic.
- Future:
  - melanoma
  - glioma, SCC—overexpressed cell receptor for EGF.

### Radionuclides for therapy

Radionuclides that have the potential for targeted therapy are the  $\alpha$ ,  $\beta$ , and Auger particle emitters (see Table 38.2). Although particle-emitting radionuclides usually produce some  $\gamma$ -ray photons as well, the photons make little contribution to the therapeutic effect.

The physical half-life of a targeting radionuclide must be long enough to allow radiochemical conjugation and the homing of the conjugate to its target tumour cells. In practice, clinical experience with targeted radiotherapy is largely confined to  $\beta$ -emitters, particularly  $^{131}\text{I}$  and, to a lesser extent,  $^{90}\text{Y}$ . The advantages of  $^{131}\text{I}$  are its availability, ease of conjugation, and clinical familiarity.

$\alpha$ -emitters have high radiobiological effectiveness and short-range emissions but are difficult to obtain and have inconveniently short half-lives. Experience with  $\alpha$ -emitters is, so far, confined to the laboratory, but encouraging clinical potential has been demonstrated.

Auger electron emitters have been little used for targeted therapy, because the short range of the Auger electron requires a DNA-targeting agent.



Table 38.1 Targeting agents for targeted radiotherapy

Biological differential	Targeting agent	Target tumour
Epitope	Antibodies	Various
Noradrenaline transporter	MIBG	Neuroblastoma
Melanin synthetic pathway	Methylene blue	Melanoma
EGFR overexpression	EGF	Squamous carcinoma, glioma
Proliferative differential	Iododeoxyuridine (IUdR)	Brain tumours
Nuclear ER	Oestrogen	Breast cancer
Genomic aberration	Oligonucleotide	?

Table 38.2 Radionuclides for targeted radiotherapy

Radionuclide	Half-life	Emitted particles	Particle range
<sup>90</sup> Y	2.7 days	$\beta$	5mm
<sup>131</sup> I	8 days	$\beta$	0.8mm
<sup>67</sup> Cu	2.5 days	$\beta$	0.6mm
<sup>199</sup> Au	3.1 days	$\beta$	0.3mm
<sup>211</sup> At	7h	$\alpha$	0.05mm
<sup>212</sup> Bi	1h	$\alpha$	0.05mm
<sup>125</sup> I	60 days	Auger electrons	1 micron
<sup>123</sup> I	15h	Auger electrons	1 micron

## Combined modalities

Targeted radiotherapy using  $\beta$ -emitters inevitably results in a whole-body radiation dose, because of limited targeting specificities (cross-targeting to normal tissues) and because of radionuclide in the general circulation.

These concepts are now being applied in the targeted radiotherapy of neuroblastoma, using  $^{131}\text{I}$ -MIBG in combination with TBI or high-dose chemotherapy. Combined-modality treatment of B-cell lymphoma, using radiolabelled antibodies, TBI, or systemic chemotherapy and haemopoietic rescue, may be an appropriate next step.

# Gene therapy and genetic immunotherapy for cancer

Introduction 760

Somatic correction of gene defect 762

Genetic pro-drug activation 764

Genetic immunomodulation 766

Gene delivery 770

Further reading 772

## Introduction

- New anti-cancer strategies are needed, as most cancers ultimately become resistant to conventional treatment modalities.
- Increasing insight into the control and growth of human cells and their deregulation in cancer has coincided with advances in recombinant DNA technology.
- Gene therapy for cancer remains firmly within the realms of clinical trials. There are currently no gene therapy treatments approved for mainstream clinical use in the UK, and clinical gene therapy trials are closely regulated by Gene Therapy Advisory Committee (GTAC).
- Occasional encouraging results in preclinical and early-phase studies have currently failed to translate into treatments with proven efficacy in phase III clinical trials.
- Worldwide—the first gene therapy product to be approved for use was Gendicine® (see ↻ Somatic correction of gene defect, p. 762).
- Early clinical trials are typically undertaken in those with advanced disease, but it seems likely that any future role for gene therapy will be greatest in those patients with low-volume or resected disease (i.e. the adjuvant setting).
- Ongoing development of new techniques means that there is an overlap between techniques used in gene therapy and in specific immunotherapy, with novel approaches drawing on both methods (immunogenetic strategies).
- This chapter aims to:
  - provide a broad overview of the principals of gene therapy
  - introduce some of the relevant terminology, and to
  - provide the reader with a platform for further reading.

Gene therapy is the transfer and expression of genetic material into a cell, a tissue, or an organ for a therapeutic purpose.

- Strategies may include the introduction of genes which:
  - correct a somatic error
  - alter the expression levels of relevant genes
  - affect cell differentiation or survival.
- Successful gene therapy will require:
  - a method of delivering that gene into the correct cell
  - a mechanism of controlling the expression of that gene.

### Strategies for cancer gene therapy

- Somatic correction of gene defect:
  - expression of tumour suppressor gene
  - anti-sense oligonucleotide to mutant oncogene.
- Genetic pro-drug activation.
- Genetic immunomodulation:
  - non-specific immunotherapy (see Chapter 9)
  - specific immunotherapy.

Immunotherapy aims to use immune mechanisms to influence the course of a disease. This may either be by enhancing the natural host immune responses or by the use of exogenous biological agents. Immunotherapy may be:

- non-specific (see Chapter 9), or
- specific—targeting a tumour-related antigen.

- The concept of a vaccine against cancer first arose when the infectious aetiology of certain malignancies was identified. Examples include:
  - HPV in cervical cancer
  - HBV in hepatocellular cancer
  - EBV in BL and nasopharyngeal cancer.
- It was then proposed that cancers with no recognizable infectious aetiology may be targeted with cancer vaccines designed against tumour-specific antigens.
- The potential advantage of this strategy is that local delivery of a gene–vector inoculation may generate a tumour-specific response that would be amplified and disseminated—targeting tumour cells at distant sites.
- The majority of current gene therapy trials involve immunogenetic techniques.
- Much effort goes into the design and implementation of cancer gene therapies and immunogenetic strategies. However, our incomplete understanding of the biological system means we have a limited ability to predict true targets *in vivo*.

## Somatic correction of gene defect

### Expression of tumour suppressor gene

- Tumour suppressor genes are genes whose function is lost in carcinogenesis. Both allele copies must be inactivated, before the tumour suppressor function is completely lost, with potential initiation or progression of a cancer.
- Replacement with normal non-mutated copies of tumour suppressor genes using viral vectors has resulted in the suppression and/or reversal of the malignant phenotype in *in vivo* tumour models.
- An example is the *p53* tumour suppressor gene:
  - many trials of cancer gene therapy have concentrated on *p53*
  - Gendicine® is a recombinant adenovirus expressing *p53* and is approved for use in China for the treatment of head and neck cancers
  - phase I and II trials, in which patients with NSCLC with mutations in *p53* have undergone intra-tumoural injection of a retroviral vector containing wild-type *p53*, have produced no consistent clinical benefit.
- There is some suggestion that combining the successful restoration of genes (such as wild-type *p53*) and the sequential administration of chemotherapy (such as cisplatin) may be synergistic in reducing the malignant expression in these cell lines.

### Correction of mutant oncogenes

- Proto-oncogenes are genes whose function becomes enhanced in carcinogenesis. The gene product is typically a protein with an essential role in controlling cellular proliferation, e.g. growth factors or transcription factors. A hereditary or acquired mutation in only one copy of the oncogene disrupts normal regulation of cellular replication.
- Anti-sense DNA oligonucleotides are short, synthetic nucleotide sequences that are complementary to specific DNA or RNA sequences and are specifically engineered to target individual oncogenes. The aim is to inhibit transcription into mRNA or translation of the mRNA message into protein. This limits gene expression and hence limits expression of the gene product.
- An example is the tumour suppressor gene *bcl-2*:
  - an apoptotic inhibitor upregulated in certain types of cancer and specifically overexpressed through chromosomal translocation in some NHLs
  - identified as playing a role in the development of tumour drug resistance
  - G3139 (oblimersen) is an anti-sense oligonucleotide targeting the initiation codon region in the *bcl-2* messenger ribonucleic acid (mRNA) and is undergoing clinical trials in many malignancies, including advanced prostate cancer, melanoma, lymphoma, and leukaemia.



## Genetic pro-drug activation

- The fundamental problem with current chemotherapy is its lack of selectivity and hence its associated toxicity. Targeting of therapy can potentially be increased by gene transfer techniques. The aim is to maximize cell kill, whilst minimizing toxicity.
- This method is variously known as:
  - genetic pro-drug activation therapy (GPAT)
  - gene-directed enzyme pro-drug therapy (GDEPT)
  - virus-directed enzyme pro-drug therapy (VDEPT), if gene transfer is via a viral vector
  - suicide gene therapy.
- Targeting could be achieved by the sequence of events shown in Fig. 39.1.
- The potential advantage of GPAT:
  - may permit success, even in the absence of highly efficient gene transfer, due to the 'bystander effect' whereby non-transduced cells in a mixed population die in the presence of a given pro-drug due to passive diffusion, active transport, or recruitment of a local immune response.
- Current limitations of GPAT include:
  - limited gene transfer efficiency at the tumour site by the vectors currently available
  - current requirement for direct intra-tumoural gene injection, so that efficacy may be restricted to solitary tumours, rather than disseminated disease.
- Early-phase trials are under way to investigate whether the theory of GPAT will translate into treatments with any real clinical benefit.
- An example of a prototype GPAT is the bacterial enzyme nitroreductase:
  - the nitroreductase gene could be introduced into tumours by direct injection
  - the enzyme nitroreductase converts the pro-drug CB1954 (which can be safely administered IV or intraperitoneally) to a highly toxic alkylating agent nitrobenzamidine that cross-links DNA
  - systemic administration of CB1954 could result in the conversion to the cytotoxic nitrobenzamidine, only where the activating gene had been incorporated
  - therapeutic efficacy has not yet been demonstrated, although trials are under way in patients with a range of cancers, including HCC and liver metastases from colorectal cancer.



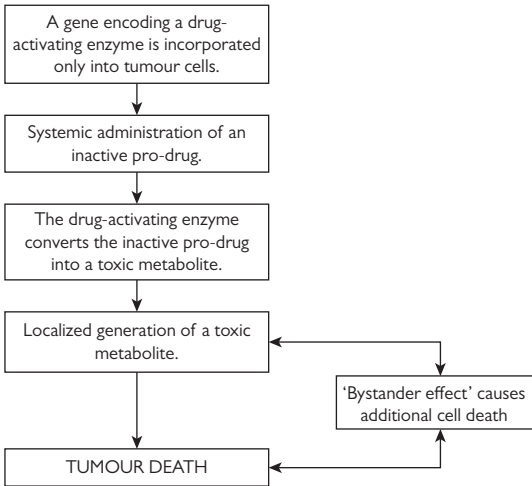

**Fig. 39.1** Potential mechanisms of tumour targeting using a pro-drug system in combination with gene therapy. Gene therapy techniques could enhance the specificity of anti-cancer agents by preferentially targeting malignant cells.

## Genetic immunomodulation

### Non-specific immunotherapy

- Aims to increase the immune responsiveness in general, rather than directing a reaction against a particular antigen.
- The patient is immunized with materials that elicit an immune reaction capable of eliminating/delaying tumour growth.
- Examples of non-specific immunotherapy include the use of BCG and cytokines, e.g. interferon alfa, IL-2 (see  Active immunotherapy, p. 190).

### Specific immunotherapy

Many techniques are being developed, with the aim of generating an immune response to a specific tumour-associated antigen:

- whole-cell tumour preparations
- peptide vaccinations
- DNA vaccines.

Methods are also being developed to improve the efficiency of antigen presentation to the immune system-associated antigen:

- dendritic cell (DC) vaccination.

Cancer vaccinations remain the focus of ongoing clinical trials.

- An ideal target antigen should have the following properties:
  - expressed solely in the tumour or only at very low levels elsewhere in the body
  - present in 1° and metastatic disease
  - available to recognition by the immune system, either by expression on the cell surface or by being processed by MHC proteins.

#### *Methods of generating tumour-specific immune reactions*

##### *Whole tumour cell preparations*

- Individual preparation of vaccination for each patient using samples from their own tumour, usually administered with an adjuvant agent, e.g. BCG.
- Advantage—avoids the need to identify specific tumour-associated antigens.
- Disadvantages—high-intensity preparation, so scope for widespread clinical application may be limited.
- Examples of the application of whole tumour cell include small-scale trials in patients with RCC and following the resection of colorectal tumours—encouraging results, with trends towards longer DFS.

##### *Peptide vaccinations*

- If an appropriate antigen can be isolated and identified, then specific peptides derived from that antigen could be developed into epitopes for immunotherapy. Subsequent exposure to the antigen should increase the possibility of tumour recognition by immune surveillance, and hence rejection.
- So far, clinical trials have examined intradermal or s/c administration, usually in combination with an immunological adjuvant such as BCG.

- Disadvantages—the need to identify specific tumour-associated antigens and to introduce the synthetic epitope in such a way as to stimulate an immune response.
- An example of a tumour-specific peptide antigen under investigation is mucin-1—a large glycoprotein expressed on the GI mucosa and overexpressed in several cancers, including pancreatic and colorectal. Currently, little evidence of clinical efficacy.

#### DNA vaccines

- Genes known to be overexpressed in malignancy can be targeted. The aim is to produce a recombinant DNA vaccine, in which a vector is used to introduce DNA encoding tumour-associated proteins. Presentation of the antigen protein induces humoral and cell-mediated immune responses.
- Disadvantage—limited by the paucity of truly tumour-specific antigens. Most target antigens are tumour-associated, rather than tumour-specific, and are normal cellular genes that are inappropriately expressed in malignant cells.
- Examples of targets for DNA vaccination strategies include:
  - *p53*—a mutated tumour suppressor gene present in >50% of all human cancers
  - *CEA*—a cell surface glycoprotein overexpressed by the majority of colorectal cancer cells and also at low levels in the normal colon and biliary epithelium. The gene encoding CEA has been incorporated into various vectors for use as a vaccine. Although many phase I and II trials confirm that the vaccine is well tolerated, there has not yet been clear evidence of clinical benefit
  - *MAGE-1*—an embryonic gene product associated with breast cancer and malignant melanoma
  - *HER2/neu receptor*—an EGFR with intracellular TK activity, overexpressed in several solid tumours, including breast, stomach, and pancreatic cancers.

#### Method of optimizing antigen presentation

##### Dendritic cell vaccination

- Although appropriate antigen selection is vital, success is dependent on an optimal presentation of those antigens to the immune system. The need to ensure an efficient antigen presentation has led to antigen administration in association with DCs.
- DCs have the following properties which make them appropriate for manipulation:
  - they are potent antigen-processing and antigen-presenting cells, critical to the development of 1° MHC-restricted T-cell immunity to infectious agents, in autoimmune diseases, and in anti-tumour immunity
  - they express high levels of MHC and co-stimulatory molecules
  - they can be expanded *in vitro* from peripheral blood precursors and marrow, using cytokines. Cultured DCs are able to take up exogenous antigen (as tumour protein, peptide, or RNA) or may be transduced with genes encoding tumour antigen, using physical or viral methods of gene transfer.

- The hope is that co-administration of antigen with DCs will maximize subsequent T-cell response, and hence the host immune recognition of the tumour-associated peptide.
- Disadvantage—DCs remain very labour-intensive to generate.
- Extensive small-scale early-phase trials have been conducted, with the most promising results in prostate cancer. However, many (high) hurdles remain, before there is any prospect of DC vaccination joining the mainstream oncological treatments.



## Gene delivery

Successful gene therapy requires a delivery system that is capable of efficient gene transfer, without causing any associated pathological effects. Current delivery systems are discussed under the headings that follow.

### Direct physical delivery of gene therapy

- Examples of physical means include:
  - injection of naked DNA into skeletal muscle by a simple needle and syringe
  - DNA transfer by liposomes
  - DNA coated on the surface of gold pellets that are air-propelled into the epidermis (the 'gene gun').
- Advantages—convenience and safety.
- Disadvantages—low efficiency of gene transfer, and the technique results in transient gene expression only.

### Use of biological vectors for delivery of gene therapy

- Examples of biological vectors include:
  - bacterial vectors
  - viral vectors (see Table 39.1).
- Advantages—it is the most efficient, stable method and permits the integration of DNA into large numbers of target cells.
- Disadvantages—the safety issues, that it is technically more complex, and the potential generation of neutralizing immune responses and systemic toxicities.

### Administration of gene therapy

- Is typically by local injection.
- Systemic administration is generally precluded by the high prevalence of cross-reacting antibodies and the high immunogenicity of the vectors.

### Efficiency of transfer of therapeutic DNA varies, and this will influence the choice of vector

For example:

- for gene replacement, high-efficiency viral vectors are desirable
- for short-term gene expression to prime an immune response or sensitize cells to radiotherapy, liposomal delivery may be adequate.

### Delivery of gene therapy

This may be:

- *ex vivo* (outside the patient)—transfer of a therapeutic gene into isolated cancer or non-cancer cells that are then re-implanted into the patient
- *in vivo*—delivery of genes to target cancer cells by exploiting transcriptional differences of specific genes between cancer and normal cells. This technique is less efficient for gene transfer.

Table 39.1 Viral vectors for gene therapy

Retrovirus	Adenovirus	Adeno-associated virus	Lentivirus	Herpes virus
<b>Advantages</b>				
Small genome	High viral titres	Small genome	Small genome	High viral titres
Carries 10kb insert	Carries 8–30kb insert	Carries 4–5kb insert	Can infect non-dividing target cells	Carries up to 15kb insert
Stable colinear integration				
Efficient gene transfer	Highly efficient gene transfer	Efficient gene transfer		Highly efficient gene transfer
		Can infect non-dividing cells		Can infect non-dividing cells
		Naturally replication-incompetent		Neural tropism
<b>Disadvantages</b>				
Immunogenicity	Immunogenicity	Immunogenicity		Immunogenicity
Requires actively dividing cells	Transient expression	Not well studied		Large genome
Small DNA sequences only carried poor transduction efficiency in human tumours	Small DNA sequences only carried	Small DNA sequences only carried		Lytic virus
Low titre, transient expression				
Random integration				
Insertional mutagenesis				

## Further reading

- Cerullo V, Koski A, Vähä-Koskela M, Hemminki A (2012). Chapter eight—Oncolytic adenoviruses for cancer immunotherapy: data from mice, hamsters, and humans. *Adv Cancer Res* **115**, 265–318.
- Kaliberov SA, Buchsbaum DJ (2012). Chapter seven—Cancer treatment with gene therapy and radiation therapy. *Adv Cancer Res* **115**, 221–63.
- Mantia-Smaldone GM and Chu CS (2013). A review of dendritic cell therapy for cancer: progress and challenges. *BioDrugs* **27**, 453–68.
- Tagawa M, Tada Y, Shimada H, Hiroshima K (2013). Gene therapy for malignant mesothelioma: current prospects and challenges. *Cancer Gene Ther* **20**, 150–6.
- Tobias A, Ahmed A, Moon KS, Lesniak MS (2013). The art of gene therapy for glioma: a review of the challenging road to the bedside. *J Neurol Neurosurg Psychiatry* **84**, 213–22.



# Biomarkers and cancer

Biomarkers and cancer 774

Clinical applications of biomarkers 778

Further reading 781

## Biomarkers and cancer

### Definition

A measurement which provides insight into the biological process underlying the cancer and/or gives clinically useful information about an individual malignancy, additional to established clinical parameters such as performance status. This can be:

- diagnostic—marker specific for the cancer
- prognostic—marker correlates with the extent of disease/natural history
- predictive—marker correlates with responsiveness/resistance to therapy
- a response assessment—marker correlates with the treatment efficacy or the development of refractory disease.

### Established biomarkers

A number of biomarkers are well established in oncological practice:

- serum AFP, HCG, and LDH are validated prognostic markers for germ cell malignancies of the testis and are key to monitoring patients during treatment and on surveillance
- tumour ER, PR, and human EGFR-2 (HER2), assessed by IHC or FISH, provide valuable predictors, both of the response to targeted therapy and the prognosis in breast cancers.

Other commonly used tumour markers include:

- serum CA125 in ovarian cancer
- serum CEA in colorectal cancer (but also elevated in, e.g. NSCLC and breast cancer)
- serum TG in follicular and papillary thyroid cancer
- serum calcitonin in medullary carcinoma of the thyroid
- urinary 5-HIAA in carcinoid tumours.

### Development of novel biomarkers

Progress in the understanding of the molecular biology of cancer has been paralleled by the development of laboratory technology in the fields of genomics and proteomics. Tissue micro-array technology has been refined, so that currently it is possible to quantify the expression of several thousands of genes in a single experiment, with only a few days' delay between biopsy and automated analysis.

Similarly, with advances in proteomics, it is estimated that plasma contains >10 000 different proteins, with concentrations varying by ten orders of magnitude. In order to study cancer-specific proteins, techniques have been developed to remove the abundant proteins (albumin, immunoglobulin, fibrinogen, etc.), to allow the separation and detection of tumour-related proteins, with the quantification of not only individual proteins, but also their phosphorylation status, which can correlate with the activity.

The past decade has also heralded in a new era in the understanding of gene regulation in cancer. We now appreciate that normal human cells express thousands of non-coding RNAs and that cancer cells misexpress these RNAs. Many of the non-coding RNAs, epitomized by the microRNA (miRNA), have regulatory functions in normal cells. The aberrant expression of miRNA promotes tumourigenesis, metastasis, and other features of cancer.

The presence of circulating tumour cells (CTCs) in the blood of patients with advanced cancer was noted >20y ago. However, it is only in the last few years, again through improved biotechnology, that fast and accurate assays of these have become available. CTCs are particularly abundant in advanced prostate cancer and breast cancer. Research is ongoing to define how best to use CTCs, examples being:

- the number of cells predicts the duration of survival in metastatic disease
- a fall in the CTCs correlates with the response and response duration after chemotherapy
- a change in the CTCs may be a useful surrogate endpoint for systemic treatment efficacy, superior to current assessment, e.g. axial imaging. There is potential value of receptor studies on CTCs to predict subsequent responsiveness to therapies.

It has also been recognized that tumour DNA can be retrieved from patients' peripheral blood. This lends itself to the same questions as the CTCs but may be somewhat easier to apply, since the technology of DNA isolation and identification has become automated and routine in many hospital laboratories.

### Signal transduction

Understanding of the cell signalling pathways that control cellular behaviour has provided many potential biomarkers for malignant disease. Most of these pathways can be triggered by extracellular factors binding to receptors, either on the cell surface or within the cell. The processes they control include:

- the activation of genes
- changes in metabolism
- cellular proliferation
- cellular death
- cellular migration.

Gene activation can lead to a cascade of effects through the production of:

- proteins with enzyme activity
- transcription factors which activate one or more genes downstream in the pathway (see Fig. 40.1).

With the advent of targeted therapies directed at growth factor receptors or their TKs, it is becoming increasingly important to identify which components of the signal transduction pathways predominate in individual cancers. For example, most GISTs are driven by mutation in *c-kit* which leads to the constitutive activation of the KIT TK, the target for the TKI imatinib. Clearly, when the pathway is disrupted by alteration downstream from the growth factor receptor, agents targeted against the receptor or its specific TK are unlikely to have significant anti-tumour effects. For example, tumours driven by *K-ras* mutations do not respond to antibody therapy directed against membrane-bound growth factor receptors or to the corresponding receptor TKIs.

**Angiogenesis**

Tumour growth and spread require the development of new blood vessels. Commonly, malignant tumours have areas of highly vascularized tissue, facilitating proliferation and growth, but other areas of low perfusion and hypoxia arise where tumour growth has outstripped angiogenesis, and these may contain tumour stem cells, relatively protected from chemotherapy and radiotherapy.

A variety of anti-cancer strategies target angiogenesis:

- antibody against VEGF—bevacizumab
- VEGF receptor TKIs have similar effects
- other agents, e.g. trastuzumab, lead to an increase in thrombospondin 1, a natural inhibitor of angiogenesis.

Currently, there are no validated biomarkers for these strategies, despite intensive research in this area over the last 10y.

**Pharmacological biomarkers***Deactivating enzymes*

Measurement of drug-specific metabolic enzyme activities can be predictive of toxicity or efficacy for a number of anti-cancer drugs or:

- thiopurine methyltransferase—low levels predict toxicity, unless 6-MP doses are reduced in the treatment of ALL
- dihydropyridine dehydrogenase—deficiency leads to increased toxicity with fluorouracil and capecitabine
- uridine diphosphate glucuronyltransferase—low levels predict toxicity from irinotecan.

*DNA repair enzymes*

DNA repair phenotype can influence:

- normal tissue susceptibility to malignant transformation, e.g. after environmental exposure to radiation or chemical carcinogens
- tumour genetic instability, leading to the loss of normal cellular controls and acquired resistance to therapies
- toxicity with standard doses of cytotoxics or radiotherapy, due to failure of normal DNA repair in healthy tissues
- tumour response/resistance to treatment with radiotherapy/chemotherapy.

*Pharmacokinetics/pharmacodynamics*

Increasingly, attempts are being made to move away from the use of anti-cancer drugs at their MTD, to the optimization of dosage of established and new agents, according to their pharmacological and biological activity in individuals:

- therapeutic drug monitoring—knowledge and measurement of a target plasma level of the drug or its metabolites to allow dose adjustment
- direct measurement of biomarker drug efficacy, e.g. protein phosphorylation
- use of surrogate endpoints, i.e. biological measures which, although independent of tumour cell kill, correlate with this.

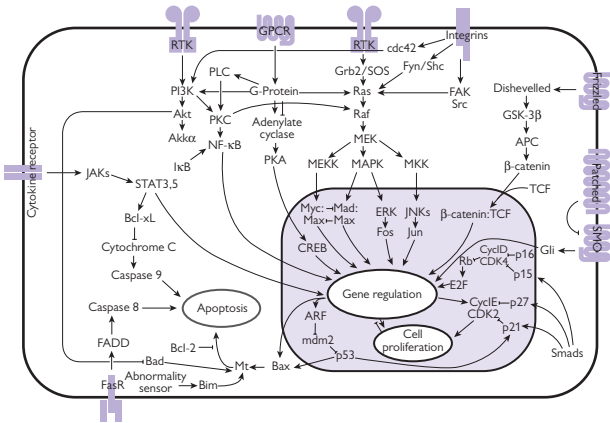

Fig. 40.1 Cell signalling pathways.

### Imaging biomarkers

Traditionally, the assessment of treatment efficacy in oncology requires comparison of imaging-based measurements to define complete response/partial response/stable disease/progressive disease:

- WHO, the original standard, using the product of bidimensional measurements of tumour masses on CT or MRI
- Response Evaluation Criteria in Solid Tumors (RECIST)
- 3D volumetric tumour assessments are currently being investigated.

Many targeted therapies exert anti-cancer effects which are cytostatic, rather than cytotoxic, so that early responses are difficult to appreciate, according to, e.g. RECIST criteria. Instead of conventional CT/MRI to assess novel therapies, specific imaging biomarkers are being developed and validated to attempt to define the biological activity of the various classes of targeted therapy:

- dynamic contrast-enhanced CT and MRI—the contrast agent allows the assessment of anti-angiogenic effects on tumour perfusion
- PET can quantitatively measure tumour perfusion ( $^{15}\text{O}$ -labelled water)
- measure tumour cell proliferation— $^{18}\text{F}$ -fluorothymidine
- PET imaging of molecular pathway receptors.

## Clinical applications of biomarkers

With the widespread use of adjuvant therapy for modest benefit in, e.g. breast and colorectal cancers, and the advent of costly targeted therapies which are active in only a minority of the cancer types for which they are licensed, there is increasing pressure to pursue the establishment of clinically relevant biomarkers for each cancer site, in order to rationalize individual treatments, according to:

- the predicted natural history of the cancer
- the predominant drivers to malignant phenotype
- the predicted responsiveness to available therapies.

### Breast cancer

The tumour stage and the ER, PR, and HER2 status remain key to the selection of adjuvant therapy, but there remains much uncertainty with regard to which individuals gain most/least from adjuvant chemotherapy, in particular amongst women with node-negative breast cancer. Recently, novel technologies have produced gene and protein signatures which have prognostic value in breast cancer, and trials are under way to prospectively evaluate its ability to improve the selection of adjuvant therapy in such patients.

Other biomarkers under investigation include:

- the tumour suppressor *PTEN* is activated by binding of trastuzumab to ErbB2, and conversely a mutation of *PTEN* confers resistance to trastuzumab
- the expression of the truncated growth factor receptor p95HER2 also leads to trastuzumab resistance
- the phosphatidylinositol-3 kinase (PI3K)/Akt/mTOR pathway represents an important therapeutic target, e.g. in relapsed ER-positive cancers, and genetic markers predicting the responsiveness to such treatment are sought
- the importance of stromal gene expression in prognosis.

### Lung cancer

Initial experience with targeted therapies for unselected patients with advanced NSCLC resulted in modest and inconsistent improvements in treatment outcome. The treatment of NSCLC has been refined, now allocated according to the pathology and specific molecular features. Targeting mutations of the EGFR with TKIs has been particularly successful, with response rates in selected patients with adenocarcinomas harbouring EGFR mutations that are significantly higher than those for conventional chemotherapy. Similar results have been reported in anaplastic lymphoma kinase-driven lung cancers treated with crizotinib.

New targets for therapy under evaluation include:

- HER2 insertions
- *BRAF* mutations
- PI3K mutations
- *FGFR* amplification
- MET overexpression
- DNA repair defects.

## Colorectal cancer

Currently, only CEA is in common use as a biomarker. However, understanding of the three pathways to colorectal cancer—chromosomal instability, microsatellite instability, and gene silencing by hypermethylation (e.g. of DNA mismatch repair enzymes)—is now complemented by research, including:

- screening for early disease/local recurrence by detection of molecular markers of pre-malignant and malignant lesions in faeces
- microsatellite instability conveys a better prognosis but paradoxically is a predictor of a lack of benefit of fluorouracil adjuvant therapy
- *k-RAS* mutations (45%) predict a poor prognosis, but also failure of therapy targeted against EGFR, e.g. cetuximab; no apparent correlation with EGFR expression, but other potential biomarkers include BRAF and PTEN
- proteomic search for a serum marker to replace CEA for follow-up/early diagnosis of relapse
- genomic markers to predict patients who do not require adjuvant therapy or close follow-up.

## Renal cell cancer

Currently, there are no established biomarkers for renal cell cancer. Given the importance of angiogenesis in this disease, the current focus of biomarker research in this tumour type includes:

- serum VEGF—a high level conveys a poor prognosis, irrespective of the treatment; during sunitinib therapy, serum VEGF elevates (produced by non-malignant stroma) but falls on withdrawal (the drug is normally taken daily for 4wk, then 2wk rest); large fluctuations predict a good response
- soluble VEGF receptor levels show an inverse pattern of fluctuation during treatment
- hypertension (frequent side effect of anti-angiogenesis therapy) correlates with a positive clinical outcome with, e.g. sunitinib
- cellular hypoxia-inducible factors (HIFs)
- basic fibroblast growth factor (bFGF)
- *VHL* mutation and the VHL protein—no proven correlation with therapeutic outcome.

## Central nervous system tumours

- Epigenetic silencing of the DNA repair gene MGMT by promoter methylation is associated with temozolomide chemosensitivity in glioblastoma.
- 1p/19q deletions predict a better survival and chemosensitivity in oligodendroglioma.

## Controversies and limitations

Whilst these developments provide great hope for the individualization of cancer therapies, they also present significant problems:

- realistically, must have short turnaround time to allow the integration of the biomarker into the therapeutic decision-making process of the MDT

- integration into conventional drug development and clinical trial design is challenging and inevitably reduces the rates of recruitment to trials where entry is limited to biomarker-positive patients
- combination therapy trials—how best to deliver conventional chemotherapy with targeted agents, sequentially or concomitant
- heterogeneity of the tumour and limited availability of biopsy material, e.g. NSCLC commonly diagnosed on cytology, rather than biopsy
- feasibility of genomic techniques with FNA versus core biopsy material
- heterogeneity between 1° and metastasis, either re-biopsy or look at CTCs, e.g. FISH for genotype
- biotechnology quality control, centralized versus local laboratories
- setting limits for therapy, e.g. what is the smallest probability of survival benefit to justify adjuvant therapy?
- acceptability of these to patients versus health economists.



## Further reading

Hanahan D, Weinberg RA (2000). Hallmarks of cancer. *Cell* **100**, 57–70.

O'Connor JP, Jackson A, Asselin MC, Buckley DL, Parker GJ, Jayson GC (2008). Quantitative imaging biomarkers in the clinical development of targeted therapeutics: current and future perspectives. *Lancet Oncol* **9**, 766–76.

Søreide K, Nedrebø BS, Knapp JC, Glomsaker TB, Søreide JA, Kørner H (2009). Evolving molecular classification by genomic and proteomic biomarkers in colorectal cancer: potential implications for the surgical oncologist. *Surg Oncol* **18**, 31–50.



## Part 7

# Appendices

Appendix 1	NCIC common toxicity criteria (CTC) grading system (March 1998, revised)	785
Appendix 2	Nomogram for the determination of body surface area	853
Appendix 3	Performance status	855
Appendix 4	Support agencies' addresses and websites	857



# NCIC common toxicity criteria (CTC) grading system (March 1998, revised)

- Common toxicity criteria (CTC) 786
- Adverse event module 840
- Infection module 841
- Performance status scales/scores 842
- RTOG/EORTC late radiation morbidity scoring scheme 844
- Bone marrow transplantation: specific adverse events 848
- Bone marrow transplantation: complex/multicomponent events 851

## Common toxicity criteria (CTC)

Adverse event	Grade				
	0	1	2	3	4
<b>ALLERGY/IMMUNOLOGY</b>					
Allergic reaction/hypersensitivity (including drug fever)	None	Transient rash, drug fever <38°C (<100.4°F)	Urticaria, drug fever ≥38°C (≥100.4°F), and/or asymptomatic bronchospasm	Symptomatic bronchospasm, requiring parenteral medication(s), with or without urticaria; allergy-related oedema/angioedema	
<p>Note: isolated urticaria, in the absence of other manifestations of an allergic or hypersensitivity reaction, is graded in the DERMATOLOGY/SKIN category</p>					
Allergic rhinitis (including sneezing, nasal stuffiness, post-nasal drip)	None	Mild, not requiring treatment	Moderate, requiring treatment	—	—
Autoimmune reaction	None	Serological or other evidence of autoimmune reaction, but patient is asymptomatic (e.g. vitiligo), all organ function is normal, and no treatment is required	Evidence of autoimmune reaction involving a non-essential organ or function (e.g. hypothyroidism), requiring treatment other than immunosuppressive drugs	Reversible autoimmune reaction involving function of a major organ or other adverse event (e.g. transient colitis or anaemia), requiring short-term immunosuppressive treatment	Autoimmune reaction causing major grade 4 organ dysfunction; progressive and irreversible reaction; long-term administration of high-dose immunosuppressive therapy required
<p>Also consider Hypothyroidism, Colitis, Haemoglobin, Haemolysis</p>					

	None	—	Present	—
Serum sickness	None	—	Present	—
Urticaria is graded in the DERMATOLOGY/SKIN category, if it occurs as an isolated symptom. If it occurs with other manifestations of allergic or hypersensitivity reaction, grade as Allergic reaction/hypersensitivity above				
Vasculitis	None	Mild, not requiring treatment	Symptomatic, requiring medication	Ischaemic changes or requiring amputation
Allergy/immunology—Other (specify, _____)	None	Mild	Moderate	Life-threatening or disabling
<b>AUDITORY/HEARING</b>				
Conductive hearing loss is graded as Middle ear/hearing in the AUDITORY/HEARING category				
Earache is graded in the PAIN category				
External auditory canal	Normal	External otitis with erythema or dry desquamation	External otitis with moist desquamation	Necrosis of the canal soft tissue or bone
Note: changes associated with radiation to the external ear (pinnae) are graded under Radiation dermatitis in the DERMATOLOGY/SKIN category				
Inner ear/hearing	Normal	Hearing loss on audiometry only	Tinnitus or hearing loss, not requiring hearing aid or treatment	Severe unilateral or bilateral hearing loss (deafness), not correctable
Middle ear/hearing	Normal	Serous otitis without subjective decrease in hearing	Serous otitis or infection requiring medical intervention; subjective decrease in hearing; rupture of tympanic membrane with discharge	Necrosis of the canal soft tissue or bone
Auditory/hearing—Other (specify, _____)	Normal	Mild	Moderate	Life-threatening or disabling

(continued)

Adverse event	Grade				
	0	1	2	3	4
<b>BLOOD/BONE MARROW</b>					
Bone marrow cellularity	Normal for age	Mildly hypocellular or $\leq 25\%$ reduction from normal cellularity for age	Moderately hypocellular or $>25\text{--}\leq 50\%$ reduction normal cellularity for age or $>2$ , but $\leq 4$ , wk to recovery of normal bone marrow cellularity	Severely hypocellular or $>50\text{--}\leq 75\%$ reduction in cellularity for age or 4–6wk to recovery of normal bone marrow cellularity	Aplasia or $>6$ wk to recovery of normal bone marrow cellularity
Normal ranges					
Children ( $\leq 18$ y)	90% cellularity average				
Younger adults (19–59y)	60–70% cellularity average				
Older adults ( $\geq 60$ y)	50% cellularity average				
Note: grade bone marrow cellularity only for changes related to the treatment, not the disease					
CD4 count	Within normal limits (WNL)	< lower limit of normal (LLN)—500/ $\text{mm}^3$	200–<500/ $\text{mm}^3$	50–<200/ $\text{mm}^3$	<50/ $\text{mm}^3$
Haptoglobin	Normal	Decreased	–	Absent	–



Haemoglobin (Hb)	WNIL	< LLN—10.0g/dL < LLN—100g/L < LLN—6.2mmol/L	8.0—<10.0g/dL 80—<100g/L 4.9—<6.2mmol/L	6.5—<8.0g/dL 65—<80g/L 4.0—<4.9mmol/L	<6.5g/dL <65g/L <4.0mmol/L
For leukaemia studies or bone marrow infiltrative/myelophthitic processes, if specified in the protocol	WNIL	10—<25% decrease from pre-treatment	25—<50% decrease from pre-treatment	50—<75% decrease from pre-treatment	≥75% decrease from pre-treatment
Haemolysis (e.g. immune haemolytic anaemia, drug-related haemolysis, other)	None	Only laboratory evidence of haemolysis (e.g. DAT, Coombs', schistocytes)	Evidence of red cell destruction and ≥2g decrease in Hb, no transfusion	Requiring transfusion and/or medical intervention (e.g. steroids)	Catastrophic consequences of haemolysis (e.g. renal failure, hypotension, bronchospasm, emergency splenectomy)
Also consider Haptoglobin, Haemoglobin					
Leucocytes (total WCC)	WNIL	< LLN— $3.0 \times 10^9/L$ < LLN—3000/mm <sup>3</sup>	≥2.0—<3.0 × 10 <sup>9</sup> /L ≥2000—<3000/mm <sup>3</sup>	≥1.0—<2.0 × 10 <sup>9</sup> /L ≥1000—<2000/mm <sup>3</sup>	<1.0 × 10 <sup>9</sup> /L <1000/mm <sup>3</sup>
For bone marrow transplantation (BMT) studies, if specified in the protocol	WNIL	≥2.0—<3.0 × 10 <sup>9</sup> /L ≥2000—<3000/mm <sup>3</sup>	≥1.0—<2.0 × 10 <sup>9</sup> /L ≥1000—<2000/mm <sup>3</sup>	≥0.5—<1.0 × 10 <sup>9</sup> /L ≥500—<1000/mm <sup>3</sup>	<0.5 × 10 <sup>9</sup> /L <500/mm <sup>3</sup>
For paediatric BMT studies (using age, race, and sex normal values), if specified in the protocol		≥75—<100% LLN	≥50—<75% LLN	≥25—50% LLN	<25% LLN

(continued)

Adverse event	Grade				
	0	1	2	3	4
Lymphopenia	WNL	< LLN- $1.0 \times 10^9/L$	$\geq 0.5$ - $<1.0 \times 10^9/L$	$<0.5 \times 10^9/L$	-
For paediatric BMT studies (using age, race, and sex normal values), if specified in the protocol		< LLN- $1000/mm^3$	$\geq 500$ - $<1000/mm^3$	$<500/mm^3$	
		$\geq 75$ - $<100\%$ LLN	$\geq 50$ - $<75\%$ LLN	$\geq 25$ - $<50\%$ LLN	$<25\%$ LLN
Neutrophils/granulocytes (absolute neutrophil count (ANC)/absolute granulocyte count (AGC))	WNL	$\geq 1.5$ - $<2.0 \times 10^9/L$	$\geq 1.0$ - $<1.5 \times 10^9/L$	$\geq 0.5$ - $<1.0 \times 10^9/L$	$<0.5 \times 10^9/L$
For BMT studies, if specified in the protocol	WNL	$\geq 1500$ - $<2000/mm^3$	$\geq 1000$ - $<1500/mm^3$	$\geq 500$ - $<1000/mm^3$	$<500/mm^3$
		$\geq 1.0$ - $<1.5 \times 10^9/L$	$\geq 0.5$ - $<1.0 \times 10^9/L$	$\geq 0.1$ - $<0.5 \times 10^9/L$	$<0.1 \times 10^9/L$
		$\geq 1000$ - $<1500/mm^3$	$\geq 500$ - $<1000/mm^3$	$\geq 100$ - $<500/mm^3$	$<100/mm^3$
For leukaemia studies or bone marrow infiltrative/myelophthitic process, if specified in the protocol	WNL	$10$ - $<25\%$ decrease from baseline	$25$ - $<50\%$ decrease from baseline	$50$ - $<75\%$ decrease from baseline	$\geq 75\%$ decrease from baseline
Platelets	WNL	< LLN- $75.0 \times 10^9/L$	$\geq 50.0$ - $<75.0 \times 10^9/L$	$\geq 10.0$ - $<50.0 \times 10^9/L$	$<10.0 \times 10^9/L$
For BMT studies, if specified in the protocol	WNL	< LLN- $75\ 000/mm^3$	$\geq 50\ 000$ - $<75\ 000/mm^3$	$\geq 10\ 000$ - $<50\ 000/mm^3$	$<10\ 000/mm^3$
		$\geq 50.0$ - $<75.0 \times 10^9/L$	$\geq 20.0$ - $<50.0 \times 10^9/L$	$\geq 10.0$ - $<20.0 \times 10^9/L$	$<10.0 \times 10^9/L$
		$\geq 50\ 000$ - $<75\ 000/mm^3$	$\geq 20\ 000$ - $<50\ 000/mm^3$	$\geq 10\ 000$ - $<20\ 000/mm^3$	$<10\ 000/mm^3$

	WNL	10–<25% decrease from baseline	25–<50% decrease from baseline	50–<75% decrease from baseline	≥75% decrease from baseline
For leukaemia studies or bone marrow infiltrative/ myelophthisic process, if specified in the protocol					
Transfusion: platelets	None	–	–	Yes	Platelet transfusions and other measures required to improve platelet increment; platelet transfusion refractoriness associated with life-threatening bleeding (e.g. HLA or cross-matched platelet transfusions)
For BMT studies, if specified in the protocol	None	One platelet transfusion in 24h	Two platelet transfusions in 24h	≥3 platelet transfusions in 24h	Platelet transfusions and other measures required to improve platelet increment; platelet transfusion refractoriness associated with life-threatening bleeding, (e.g. HLA or cross-matched platelet transfusions)
Also consider Platelets					
Transfusion: packed red blood cells (pRBCs)	None	–	–	Yes	–

(continued)

Adverse event	Grade				
	0	1	2	3	4
For BMT studies, if specified in the protocol	None	≤2 units of pRBCs in 24h, elective or planned	3 units of pRBCs in 24h, elective or planned	≥4 units of pRBC in 24h	Haemorrhage or haemolysis associated with life-threatening anaemia; medical intervention required to improve Hb
For paediatric BMT studies, if specified in the protocol	None	≤15mL/kg in 24h, elective or planned	>15–≤30mL/kg in 24h, elective or planned	>30mL/kg in 24h	Haemorrhage or haemolysis associated with life-threatening anaemia; medical intervention required to improve Hb
Also consider Haemoglobin					
Blood/bone marrow—Other (specify: _____)	None	Mild	Moderate	Severe	Life-threatening or disabling
<b>CARDIOVASCULAR (ARRHYTHMIA)</b>					
Conduction abnormality/atrioventricular (AV) heart block	None	Asymptomatic, not requiring treatment (e.g. Mobitz type I second-degree AV block, Wenckebach)	Symptomatic, but not requiring treatment	Symptomatic and requiring treatment (e.g. Mobitz type II second-degree AV block, third-degree AV block)	Life-threatening (e.g. arrhythmia associated with congestive heart failure (CHF), hypotension, syncope, shock)

Nodal/junctional arrhythmia/dysrhythmia	None	Asymptomatic, not requiring treatment	Symptomatic, but not requiring treatment	Symptomatic and requiring treatment	Life-threatening (e.g. arrhythmia associated with CHF, hypotension, syncope, shock)
Palpitations	None	Present	–	–	–
Note: grade palpitations only in the absence of a documented arrhythmia					
Prolonged QTc interval (>0.48s)	None	Asymptomatic, not requiring treatment	Symptomatic, but not requiring treatment	Symptomatic and requiring treatment	Life-threatening (e.g. arrhythmia associated with CHF, hypotension, syncope, shock)
Sinus bradycardia	None	Asymptomatic, not requiring treatment	Symptomatic, but not requiring treatment	Symptomatic and requiring treatment	Life-threatening (e.g. arrhythmia associated with CHF, hypotension, syncope, shock)
Sinus tachycardia	None	Asymptomatic, not requiring treatment	Symptomatic, but not requiring treatment	Symptomatic and requiring treatment of underlying cause	–
Supraventricular arrhythmias (supraventricular tachycardia (SVT) / AF / atrial flutter)	None	Asymptomatic, not requiring treatment	Symptomatic, but not requiring treatment	Symptomatic and requiring treatment	Life-threatening (e.g. arrhythmia associated with CHF, hypotension, syncope, shock)
Syncope (fainting) is graded in the NEUROLOGY category					
Vasovagal episode	None	–	Present without loss of consciousness	Present with loss of consciousness	–

(continued)

Adverse event	Grade				
	0	1	2	3	4
Ventricular arrhythmia (premature ventricular contractions (PVCs)/bigemini/trigemini/ventricular tachycardia)	None	Asymptomatic, not requiring treatment	Symptomatic, but not requiring treatment	Symptomatic and requiring treatment	Life-threatening (e.g. arrhythmia associated with CHF, hypotension, syncope, shock)
Cardiovascular/arrhythmia—Other (specify, _____)	None	Asymptomatic, not requiring treatment	<i>Symptomatic, but not requiring treatment</i>	Symptomatic and requiring treatment of underlying cause	Life-threatening (e.g. arrhythmia associated with CHF, hypotension, syncope, shock)
<b>CARDIOVASCULAR (GENERAL)</b>					
Acute vascular leak syndrome	Absent	—	Symptomatic, but not requiring fluid support	Respiratory compromise or requiring fluids	Life-threatening: requiring pressor support and/or ventilatory support
Cardiac ischaemia/infarction	None	Non-specific T-wave flattening or changes	Asymptomatic, ST- and T-wave changes suggesting ischaemia	Angina without evidence of infarction	Acute MI
Cardiac left ventricular function	Normal	Asymptomatic decline of resting ejection fraction of $\geq 10\%$ , but $< 20\%$ of baseline value; shortening fraction of $\geq 24\%$ , but $< 30\%$	Asymptomatic, but resting ejection fraction below LLN for laboratory or decline of resting ejection fraction of $\geq 20\%$ of baseline value; $< 24\%$ shortening fraction	CHF responsive to treatment	Severe or refractory CHF or requiring intubation

## CNS cerebrovascular ischaemia is graded in the NEUROLOGY category

Cardiac troponin I (cTnI)	Normal	–	–	Levels consistent with unstable angina, as defined by the manufacturer	Levels consistent with MI, as defined by the manufacturer
Cardiac troponin T (cTnT)	Normal	$\geq 0.03$ – $<0.05$ ng/mL	$\geq 0.05$ – $<0.1$ ng/mL		$\geq 0.1$ – $<0.2$ ng/mL
Oedema	None	Asymptomatic, not requiring therapy	Symptomatic, requiring therapy	Symptomatic oedema, limiting function and unresponsive to therapy or requiring drug discontinuation	Anasarca (severe generalized oedema)
Hypertension	None	Asymptomatic, transient increase by $>20$ mmHg (diastolic) or to $>150/100^*$ if previously WNL; not requiring treatment	Recurrent or persistent, symptomatic increase by $>20$ mmHg (diastolic) or to $>150/100^*$ if previously WNL; not requiring treatment	Requiring therapy or more intensive therapy than previously	Hypertensive crisis

\* Note: for paediatric patients, use age- and sex-appropriate normal values  $>95$ th percentile of the upper limit of normal (ULN)

Hypotension	None	Changes, but not requiring therapy (including transient orthostatic hypotension)	Requiring brief fluid replacement or other therapy, but not hospitalization; no physiological consequences	Requiring therapy and sustained medical attention but resolves without persisting physiological consequences	$\uparrow$ shock (associated with acidemia and impairing vital organ function due to tissue hypoperfusion)
-------------	------	--	--	--	--

(continued)

Adverse event	Grade				
	0	1	2	3	4
Also consider Syncope (fainting)					
Notes: angina or MI is graded as Cardiac ischaemia/infarction in the CARDIOVASCULAR (GENERAL) category For paediatric patients, systolic BP 65mmHg or less in infants up to 1y old and 70mmHg or less in children older than 1y of age, use two successive or three measurements in 24h					
Myocarditis	None	–	–	CHF responsive to treatment	Severe or refractory CHF
Operative injury of vein/artery	None	1° suture repair for injury, but not requiring transfusion	1° suture repair for injury, requiring transfusion	Vascular occlusion requiring surgery or bypass for injury	MI; resection of organ (e.g. bowel, limb)
Pericardial effusion/pericarditis	None	Asymptomatic effusion, not requiring treatment	Pericarditis (rub, ECG changes, and/or chest pain)	With physiological consequences	Tamponade (drainage or pericardial window required)
Peripheral arterial ischaemia	None	–	Brief episode of ischaemia, managed non-surgically and without permanent deficit	Requiring surgical intervention	Life-threatening or with permanent functional deficit (e.g. amputation)
Phlebitis (superficial)	None	–	Present	–	–
Notes: injection site reaction is graded in the DERMATOLOGY/SKIN category					
Thrombosis/embolism is graded in the CARDIOVASCULAR (GENERAL) category					
Syncope (fainting) is graded in the NEUROLOGY category					



Thrombosis/embolism	None	–	DVT, not requiring anticoagulant	DVT, requiring anticoagulant therapy	Embolus event, including PE
Vein/artery operative injury is graded as Operative injury of vein/artery in the CARDIOVASCULAR (GENERAL) category					
Visceral arterial ischaemia (non-myocardial)	None	Brief episode of ischaemia, managed non-surgically and without permanent deficit	Requiring surgical intervention	Life-threatening or with permanent functional deficit (e.g. resection of ileum)	
Cardiovascular/general—Other (specify: _____)	None	Mild	Moderate	Severe	Life-threatening or disabling
<b>COAGULATION</b>					
Note: see the HAEMORRHAGE category for grading the severity of bleeding events.					
DIC	Absent	–	–	Laboratory findings present with no bleeding	Laboratory findings and bleeding
Also consider Platelets					
Note: must have increased fibrin-split products or D-dimer in order to grade as DIC					
Fibrinogen	WNL	$\geq 0.75$ – $<1.0 \times$ LLN	$\geq 0.5$ – $<0.75 \times$ LLN	$\geq 0.25$ – $<0.5 \times$ LLN	$<0.25 \times$ LLN
For leukaemia studies or bone marrow infiltrative/myelophthitic process, if specified in the protocol	WNL	$<20\%$ decrease from pre-treatment value or LLN	$\geq 20$ – $<40\%$ decrease from pre-treatment value or LLN	$\geq 40$ – $<70\%$ decrease from pre-treatment value or LLN	$<50\text{mg}$

(continued)

Adverse event	Grade				
	0	1	2	3	4
Partial thromboplastin time (PTT)	WNL	>ULN–≤1.5 × ULN	>1.5–≤2 × ULN	>2 × ULN	–
Phlebitis is graded in the CARDIOVASCULAR (GENERAL) category					
Prothrombin time (PT)	WNL	>ULN–≤1.5 × ULN	>1.5–≤2 × ULN	>2 × ULN	–
Thrombosis/embolism is graded in the CARDIOVASCULAR (GENERAL) category					
Thrombotic microangiopathy, e.g. thrombotic thrombocytopenic purpura (TTP) or haemolytic uraemic syndrome (HUS)	–	–	–	Laboratory findings present without clinical consequences	Laboratory findings and clinical consequences (e.g. CNS haemorrhage/bleeding or thrombosis/embolism or renal failure), requiring therapeutic intervention
For BMT studies, if specified in the protocol.	–	Evidence of red blood cell (RBC) destruction (schistocytosis) without clinical consequences	Evidence of RBC destruction with elevated creatinine (≤3 × ULN)	Evidence of RBC destruction with creatinine >3 × ULN, not requiring dialysis	Evidence of RBC destruction, with renal failure requiring dialysis and/or encephalopathy
Also consider Haemoglobin, Platelets, Creatinine					
Note: must have microangiopathic changes on blood smear (e.g. schistocytes, helmet cells, red cell fragments)					
Coagulation—Other (specify, _____)	None	Mild	Moderate	Severe	Life-threatening or disabling

## CONSTITUTIONAL SYMPTOMS

Fatigue (lethargy, malaise, asthenia)      None      Increased fatigue over baseline, but not altering normal activities      Moderate (e.g. decrease in performance status by 1 ECOG level or 20% Karnofsky or Lansky) or causing difficulty performing some activities      Severe (e.g. decrease in performance status by  $\geq 2$  ECOG levels or 40% Karnofsky or Lansky) or loss of ability to perform some activities      Bedridden or disabling

Note: see Appendix 3 for performance status scales

Fever (in the absence of neutropenia where neutropenia is defined as  $AGC < 1.0 \times 10^9/L$ )      None      38.0–39.0°C (100.4–102.2°F)      39.1–40.0°C (102.3–104.0°F)       $>40.0^\circ\text{C}$  ( $>104.0^\circ\text{F}$ ) for  $>24\text{h}$        $>40.0^\circ\text{C}$  ( $>104.0^\circ\text{F}$ ) for  $>24\text{h}$

Also consider Allergic reaction/hypersensitivity

Note: the temperature measurements listed above are oral or tympanic

Hot flashes/flushes are graded in the ENDOCRINE category

Rigors, chills      None      Mild, requiring symptomatic treatment (e.g. blanket) or non-narcotic medication      Severe and/or prolonged, requiring narcotic medication      Not responsive to narcotic medication

Sweating (diaphoresis)      Normal      Mild and occasional      Frequent or drenching

(continued)

Adverse event	Grade				
	0	1	2	3	4
Weight gain	<5%	5–<10%	10–<20%	≥20%	–
Also consider ascites, oedema, pleural effusion (non-malignant)					
Weight gain associated with veno-occlusive disease (VOD) for BMT studies, if specified in the protocol	<2%	≥2–<5%	≥5–<10%	≥10% or as ascites	≥10% or fluid retention, resulting in pulmonary failure
Also consider Ascites, Oedema, Pleural effusion (non-malignant)					
Weight loss	<5%	5–<10%	10–<20%	≥20%	–
Also consider vomiting, dehydration, diarrhoea					
Constitutional Symptoms—Other (specify, _____)	None	Mild	Moderate	Severe	Life-threatening or disabling
<b>DERMATOLOGY/SKIN</b>					
Alopecia	Normal	Mild hair loss	Pronounced hair loss	–	–
Bruising (in absence of grade 3 or 4 thrombocytopenia)	None	Localized or in dependent area	Generalized	–	–

Note: bruising resulting from grade 3 or 4 thrombocytopenia is graded as petechiae/purpura and haemorrhage/bleeding with grade 3 or 4 HAEMORRHAGE category, not in the DERMATOLOGY/SKIN category

Dry skin	Normal	Controlled with emollients	Not controlled with emollients	–	–
Erythema multiforme (e.g. Stevens-Johnson syndrome, toxic epidermal necrolysis)	Absent	–	Scattered, but not generalized eruption	Severe or requiring IV fluids (e.g. generalized rash or painful stomatitis)	Life-threatening (e.g. exfoliative or ulcerating dermatitis or requiring enteral or parenteral nutritional support)
Flushing	Absent	Present	–	–	–
Hand-foot skin reaction	None	Skin changes or dermatitis without pain (e.g. erythema, peeling)	Skin changes with pain, not interfering with function	Skin changes with pain, interfering with function	–
Injection site reaction	None	Pain or itching or erythema	Pain or swelling, with inflammation or phlebitis	Ulceration or necrosis that is severe or prolonged, or requiring surgery	–
Nail changes	Normal	Discoloration or ridging (koilonychia) or pitting	Partial or complete loss of nail(s) or pain in nail beds	–	–
Petechiae is graded in the HAEMORRHAGE category					
Photosensitivity	None	Painless erythema	Painful erythema	Erythema with desquamation	–
Pigmentation changes (e.g. vitiligo)	None	Localized pigmentation changes	Generalized pigmentation changes	–	–

(continued)

Adverse event	Grade				
	0	1	2	3	4
Pruritus	None	Mild or localized, relieved spontaneously or by local measures	Intense or widespread, relieved spontaneously or by systemic measures	Intense or widespread and poorly controlled despite treatment	–
Purpura is graded in the HAEMORRHAGE category					
Radiation dermatitis	None	Faint erythema or dry desquamation	Moderate to brisk erythema or a patchy moist desquamation, mostly confined to skinfolds and creases; moderate oedema	Confluent, moist desquamation $\geq 1.5\text{cm}$ in diameter and not confined to skinfolds; pitting oedema	Skin necrosis or ulceration of full-thickness dermis; may include bleeding not induced by minor trauma or abrasion
Note: pain associated with radiation dermatitis is graded separately in the PAIN category as Pain due to radiation					
Radiation recall reaction (reaction following chemotherapy in the absence of additional radiation therapy that occurs in a previous radiation port)	None	Faint erythema or dry desquamation	Moderate to brisk erythema or a patchy moist desquamation, mostly confined to skinfolds and creases; moderate oedema	Confluent, moist desquamation $\geq 1.5\text{cm}$ in diameter and not confined to skinfolds; pitting oedema	Skin necrosis or ulceration of full-thickness dermis; may include bleeding not induced by minor trauma or abrasion

Rash/desquamation	None	Macular or papular eruption or erythema, without associated symptoms	Macular or papular eruption or erythema, with pruritus or other associated symptoms covering <50% of body surface area or localized desquamation or other lesions covering <50% of body surface area	Symptomatic generalized erythroderma or macular, papular, or vesicular eruption or desquamation covering ≥50% of body surface area	Generalized exfoliative dermatitis or ulcerative dermatitis
Also consider Rash/dermatitis associated with high-dose chemotherapy or BMT studies	None	Faint erythema or dry desquamation	Moderate to brisk erythema or a patchy moist desquamation, mostly confined to skinfolds and creases; moderate oedema	Confluent, moist desquamation ≥1.5cm in diameter and not confined to skinfolds; pitting oedema	Skin necrosis or ulceration of full-thickness dermis; may include spontaneous bleeding not induced by minor trauma or abrasion

(continued)

Adverse event	Grade				
	0	1	2	3	4
Rash/desquamation associated with graft-versus-host disease (GVHD) for BMT studies, if specified in the protocol	None	Macular or papular eruption or erythema, covering <25% of body surface area, without associated symptoms	Macular or papular eruption or erythema, with pruritus or other associated symptoms covering ≥25–<50% of body surface area or localized desquamation or other lesions covering ≥25–<50% of body surface area	Symptomatic generalized erythroderma or symptomatic macular, papular, or vesicular eruption, with bullous formation, or desquamation covering >50% of body surface area	Generalized exfoliative dermatitis or ulcerative dermatitis or bullous formation
Also consider Allergic reaction/hypersensitivity					
Note: Stevens–Johnson syndrome is graded separately as Erythema multiforme in the DERMATOLOGY/SKIN category					
Urticaria (hives, welts, wheals)	None	Requiring no medication	Requiring PO or topical treatment or IV medication or steroids for <24h	Requiring IV medication or steroids for ≥24h	–
Wound—infectious	None	Cellulitis	Superficial infection	Infection requiring IV antibiotics	Necrotizing fasciitis
Wound—non-infectious	None	Incisional separation	Incisional hernia	Fascial disruption without evisceration	Fascial disruption with evisceration
Dermatology/skin—Other (specify _____)	None	Mild	Moderate	Severe	Life-threatening or disabling



<b>ENDOCRINE</b>			
Cushingoid appearance (e.g. moon face, buffalo hump, centripetal obesity, cutaneous striae)	Absent	Present	—
Also consider Hyperglycaemia, Hypokalaemia			
Feminization of ♂	Absent	Present	—
Gynaecomastia	None	Pronounced or painful	—
Hot flashes/flushes	None	Moderate and >1 per day	—
Hypothyroidism	Absent	Asymptomatic, TSH elevated, no therapy given	Myxoedema coma
Masculinization of ♀	Absent	Symptomatic or thyroid replacement treatment given	Patient hospitalized for manifestations of hypothyroidism
SIADH	Absent	—	Present
Endocrine—Other (specify, _____)	None	Mild	Present
<b>GASTROINTESTINAL</b>			
Amylase is graded in the METABOLIC/LABORATORY category			
Anorexia	None	Oral intake significantly decreased	Requiring IV fluids
			Requiring feeding tube or parenteral nutrition

(continued)

Adverse event	Grade			
	0	1	2	3
Ascites (non-malignant)	None	Asymptomatic	Symptomatic, requiring diuretics	Symptomatic, requiring therapeutic paracentesis
Colitis	None	-	Abdominal pain with mucus and/or blood in stool	Abdominal pain, fever, change in bowel habits with ileus or peritoneal signs, and radiographic or biopsy documentation
Also consider Haemorrhage/bleeding with grade 3 or 4 thrombocytopenia, Haemorrhage/bleeding without grade 3 or 4 thrombocytopenia, Melaena/GI bleeding, Rectal bleeding/haematochezia, Hypotension				
Constipation	None	Requiring stool softener or dietary modification	Requiring laxatives	Obstipation, requiring manual evacuation or enema
Dehydration	None	Dry mucous membranes and/or diminished skin turgor	Requiring IV fluid replacement (brief)	Requiring IV fluid replacement (sustained)
Also consider Diarrhoea, Vomiting, Stomatitis/pharyngitis (oral/pharyngeal mucositis), Hypotension				
Diarrhoea patients without colostomy	None	Increase of <4 stools/day over pre-treatment	Increase of 4-6 stools/day or nocturnal stools	Increase of ≥7 stools/day or incontinence; or need for parenteral support for dehydration
				Physiological consequences requiring intensive care; haemodynamic collapse
				Physiological consequences requiring intensive care; haemodynamic collapse

Patients with a colostomy	None	Mild increase in loose, watery colostomy output, compared with pre-treatment	Moderate increase in loose, watery colostomy output, compared with pre-treatment, but not interfering with normal activity	Severe increase in loose, watery colostomy output, compared with pre-treatment, interfering with normal activity	Physiologic consequences, requiring intensive care; or haemodynamic collapse
Diarrhoea associated with GVHD for BMT studies, if specified in the protocol	None	>500–≤1000mL of diarrhoea/day	>1000–≤1500mL of diarrhoea/day	>1500mL of diarrhoea/day	Severe abdominal pain, with or without ileus
For paediatric BMT studies, if specified in the protocol		>5–≤10mL/kg of diarrhoea/day	>10–≤15mL/kg of diarrhoea/day	>15mL/kg of diarrhoea/day	–
Also consider Haemorrhage/bleeding with grade 3 or 4 thrombocytopenia, Haemorrhage/bleeding without grade 3 or 4 thrombocytopenia, Pain, Dehydration, Hypotension					
Duodenal ulcer (requires radiographic or endoscopic documentation)	None	–	Requiring medical management or non-surgical treatment	Uncontrolled by outpatient medical management; requiring hospitalization	Perforation or bleeding, requiring emergency surgery
Duodenal ulcer (requires radiographic or endoscopic documentation)	None	–	Requiring medical management or non-surgical treatment	Uncontrolled by outpatient medical management; requiring hospitalization	Perforation or bleeding, requiring emergency surgery
Dyspepsia/heartburn	None	Mild	Moderate	Severe	–

(continued)

Adverse event	Grade				
	0	1	2	3	4
Dysphagia, oesophagitis, odynophagia (painful swallowing)	None	Mild dysphagia, but can eat regular diet	Dysphagia, requiring predominantly pureed, soft, or liquid diet	Dysphagia, requiring IV hydration	Complete obstruction (cannot swallow saliva); requiring enteral or parenteral nutritional support, or perforation
Note: if the adverse event is radiation-related, grade either under Dysphagia—oesophageal related to radiation or Dysphagia—pharyngeal related to radiation					
Dysphagia—oesophageal related to radiation	None	Mild dysphagia, but can eat regular diet	Dysphagia, requiring predominantly pureed, soft, or liquid diet	Dysphagia, requiring feeding tube, IV hydration, or hyperalimentation	Complete obstruction (cannot swallow saliva); ulceration with bleeding not induced by minor trauma or abrasion or perforation
Also consider Pain due to radiation, Mucositis due to radiation					
Note: Fistula is graded separately as Fistula—oesophageal					
Dysphagia—pharyngeal related to radiation	None	Mild dysphagia, but can eat regular diet	Dysphagia, requiring predominantly pureed, soft, or liquid diet	Dysphagia, requiring feeding tube, IV hydration, or hyperalimentation	Complete obstruction (cannot swallow saliva); ulceration with bleeding not induced by minor trauma or abrasion or perforation
Also consider Pain due to radiation, Mucositis due to radiation					
Note: fistula is graded separately as Fistula—pharyngeal					

Fistula—oesophageal	None	—	Present	Requiring surgery
Fistula—intestinal	None	—	Present	Requiring surgery
Fistula—pharyngeal	None	—	Present	Requiring surgery
Fistula—rectal/anal	None	—	Present	Requiring surgery
Flatulence	None	Mild	—	—
Gastric ulcer (requires radiographic or endoscopic documentation)	None	Requiring medical management or non-surgical treatment	Bleeding without perforation, uncontrolled by outpatient medical management; requiring hospitalization or surgery	Perforation or bleeding, requiring emergency surgery
Also consider Haemorrhage/bleeding with grade 3 or 4 thrombocytopenia, Haemorrhage/bleeding without grade 3 or 4 thrombocytopenia				
Gastritis	None	—	Requiring medical management or non-surgical treatment	Uncontrolled by outpatient medical management; requiring hospitalization or surgery
Also consider Haemorrhage/bleeding with grade 3 or 4 thrombocytopenia, Haemorrhage/bleeding without grade 3 or 4 thrombocytopenia				
Haematemesis is graded in the HAEMORRHAGE category				
Haematochezia is graded in the HAEMORRHAGE category as Rectal bleeding/haematochezia				
Ileus (or neuroconstipation)	None	—	Intermittent, not requiring intervention	Requiring non-surgical intervention

(continued)

Adverse event	Grade				
	0	1	2	3	4
Mouth dryness	Normal	Mild	Moderate	–	–
<b>MUCOSITIS</b>					
Notes: mucositis not due to radiation is graded in the GASTROINTESTINAL category for specific sites: colitis, oesophagitis, gastritis, stomatitis/ pharyngitis (oral/pharyngeal mucositis), and typhlitis; or the RENAL/GENITOURINARY category for vaginitis					
Radiation-related mucositis is graded as Mucositis due to radiation					
Mucositis due to radiation	None	Erythema of the mucosa	Patchy pseudomembranous reaction (patches generally ≤1.5cm in diameter and non-contiguous)	Confluent pseudomembranous reaction (contiguous patches generally >1.5cm in diameter)	Necrosis or deep ulceration; may include bleeding not induced by minor trauma or abrasion
Also consider Pain due to radiation					
Notes: grade radiation mucositis of the larynx here. Dysphagia related to radiation is also graded as either Dysphagia—oesophageal related to radiation or Dysphagia—pharyngeal related to radiation, depending on the site of treatment					
Nausea	None	Able to eat	Oral intake significantly decreased	No significant intake, requiring IV fluids	–
Pancreatitis	None	–	–	Abdominal pain, with pancreatic enzyme elevation	Complicated by shock (acute circulatory failure)
Also consider Hypotension					
Note: amylase is graded in the METABOLIC/LABORATORY category					

## Pharyngitis is graded in the GASTROINTESTINAL category as stomatitis/pharyngitis (oral/pharyngeal mucositis)

Proctitis	None	Increased stool frequency, occasional blood-streaked stools, or rectal discomfort (including haemorrhoids) not requiring medication	Increased stool frequency, bleeding, mucus discharge, or rectal discomfort requiring medication; anal fissure necessitating pads	Increased stool frequency/diarrhoea requiring parental support; rectal bleeding requiring transfusion; or persistent mucus discharge	Perforation, bleeding, or necrosis or other life-threatening complication requiring surgical intervention (e.g. colostomy)
-----------	------	---	--	--	--

Also consider Haemorrhage/bleeding with grade 3 or 4 thrombocytopenia, Haemorrhage/bleeding without grade 3 or 4 thrombocytopenia, Pain due to radiation

Notes: fistula is graded separately as Fistula—rectal/anal

Proctitis occurring >90 days after the start of radiation therapy is graded in the RTOG/EORTC late radiation morbidity scoring scheme (see **RTOG/EORTC** late radiation morbidity scoring scheme, p. 844)

Salivary gland changes	None	Slightly thickened saliva; may have slightly altered taste (e.g. metallic); additional fluids may be required	Thick, ropy, sticky saliva; markedly altered taste; alteration in diet required	—	Acute salivary gland necrosis
------------------------	------	---	---	---	-------------------------------

Sense of smell	Normal	Slightly altered	Markedly altered	—	—
Stomatitis/pharyngitis (oral/pharyngeal mucositis)	None	Painless ulcers, erythema, or mild soreness in the absence of lesions	Painful erythema, oedema, or ulcers, but can eat or swallow	Painful erythema, oedema, or ulcers requiring IV hydration	Severe ulceration or requires parental or enteral nutritional support or prophylactic intubation

(continued)

Adverse event	Grade				
	0	1	2	3	4
For BMT studies, if specified in the protocol	None	Painless ulcers, erythema, or mild soreness in the absence of lesions	Painful erythema, oedema or ulcers, but can swallow	Painful erythema, oedema, or ulcers, preventing swallowing or requiring hydration or parenteral (or enteral) nutritional support	Severe ulceration, requiring prophylactic intubation or resulting in documented aspiration pneumonia
Note: radiation-related mucositis is graded as Mucositis due to radiation					
Taste disturbance (dysgeusia)	Normal	Slightly altered	Markedly altered	-	-
Typhlitis (inflammation of the caecum)	None	-	-	≥6 episodes in 24h over pre-treatment; or need for IV fluids	Perforation, bleeding, or necrosis or other life-threatening complication requiring surgical intervention (e.g. colostomy)
Also consider Haemorrhage/bleeding with grade 3 or 4 thrombocytopenia, Haemorrhage/bleeding without grade 3 or 4 thrombocytopenia, Hypotension, Febrile neutropenia					
Vomiting	None	Over pre-treatment	2-5 episodes in 24h over pre-treatment	≥6 episodes in 24h over pre-treatment; or need for IV fluids	Requiring parenteral nutrition; or physiological consequences requiring intensive care; haemodynamic collapse
Also consider Dehydration					
Weight gain is graded in the CONSTITUTIONAL SYMPTOMS category					



Weight loss is graded in the CONSTITUTIONAL SYMPTOMS category

Gastrointestinal—Other (specify, _____)	None	Mild	Moderate	Severe	Life-threatening or disabling
---	------	------	----------	--------	-------------------------------

#### HAEMORRHAGE

Notes: transfusion in this section refers to pRBC infusion

For any bleeding with grade 3 or 4 platelets (<50 000), always grade haemorrhage/bleeding with grade 3 or 4 thrombocytopenia. Also consider Platelets, transfusion: pRBCs, and Transfusion: platelets, in addition to grading severity, by grading the site or type of bleeding. If the site or type of haemorrhage/bleeding is listed, also use the grading that incorporates the site of bleeding: CNS haemorrhage/bleeding, haematuria, haematemesis, haemoptysis, haemorrhage/bleeding with surgery, melaena/lower GI bleeding, petechiae/purpura (haemorrhage/bleeding into skin), rectal bleeding/haematochezia, vaginal bleeding

If the platelet count is  $\geq 50\ 000/\text{mm}^3$  and the site or type of bleeding is listed, grade the specific site. If the site or type is not listed and the platelet count is  $\geq 50\ 000/\text{mm}^3$ , grade haemorrhage/bleeding without grade 3 or 4 thrombocytopenia, and specify the site or type in the OTHER category

Haemorrhage/bleeding with grade 3 or 4 thrombocytopenia	None	Mild without transfusion	Requiring transfusion	Catastrophic bleeding, requiring major non-elective intervention
---	------	--------------------------	-----------------------	--

Also consider platelets, Haemoglobin, Transfusion: platelets, Transfusion: pRBCs, site or type of bleeding. If the site is not listed, grade as

Haemorrhage—Other (specify, \_\_\_\_\_)

Note: this adverse event must be graded for any bleeding with grade 3 or 4 thrombocytopenia

Haemorrhage/bleeding without grade 3 or 4 thrombocytopenia	None	Mild without transfusion	Requiring transfusion	Catastrophic bleeding, requiring major non-elective intervention
--	------	--------------------------	-----------------------	--

Also consider Platelets, Haemoglobin, Transfusion: platelets; Transfusion: pRBCs, haemorrhage—Other (specify, \_\_\_\_\_)

Note: bleeding in the absence of grade 3 or 4 thrombocytopenia is graded here only if the specific site or type of bleeding is not listed elsewhere in the HAEMORRHAGE category. Also grade as Other in the HAEMORRHAGE category

(continued)

Adverse event	Grade				
	0	1	2	3	4
CNS haemorrhage/ bleeding	None	–	–	Bleeding noted on CT or other scan with no clinical consequences	Haemorrhagic stroke or haemorrhagic CVA with neurological signs and symptoms
Epistaxis	None	Mild without transfusion	–	Requiring transfusion	Catastrophic bleeding, requiring major non- elective intervention
Haematemesis	None	Mild without transfusion	–	Requiring transfusion	Catastrophic bleeding, requiring major non- elective intervention
Haematuria (in the absence of vaginal bleeding)	None	Microscopic only	Intermittent gross bleeding, no clots	Persistent gross bleeding or clots; may require catheterization or instrumentation, or transfusion	Open surgery or necrosis or deep bladder ulceration
Haemoptysis	None	Mild without transfusion	–	Requiring transfusion	Catastrophic bleeding, requiring major non- elective intervention
Haemorrhage/bleeding associated with surgery	None	Mild without transfusion	–	Requiring transfusion	Catastrophic bleeding, requiring major non- elective intervention

Note: expected blood loss at the time of surgery is not graded as an adverse event

Melaena/GI bleeding	None	Mild without transfusion	–	Requiring transfusion	Catastrophic bleeding, requiring major non-elective intervention
Petechiae/purpura (haemorrhage/bleeding into skin or mucosa)	None	Rare petechiae of skin	Petechiae or purpura in dependent areas of skin	Generalized petechiae or purpura of skin or petechiae of any mucosal site	–
Rectal bleeding/haematochezia	None	Mild without transfusion or medication	Persistent, requiring medication (e.g. steroid suppositories) and/or break from radiation treatment	Requiring transfusion	Catastrophic bleeding, requiring major non-elective intervention
Vaginal bleeding	None	Spotting, requiring <2 pads per day	Requiring ≥2 pads per day, but not requiring transfusion	Requiring transfusion	Catastrophic bleeding, requiring major non-elective intervention
Haemorrhage—Other (specify site, _____)	None	Mild without transfusion		Requiring transfusion	Catastrophic bleeding, requiring major non-elective intervention
<b>HEPATIC</b>					
Alkaline phosphatase	WNL	>ULN–2.5 × ULN	>2.5–5.0 × ULN	>5.0–20.0 × ULN	>20.0 × ULN
Bilirubin	WNL	>ULN–1.5 × ULN	>1.5–3.0 × ULN	>3.0–10.0 × ULN	>10.0 × ULN
Bilirubin associated with GVHD for BMT studies, if specified in the protocol	Normal	≥2–<3mg/100mL	≥3–<6mg/100mL	≥6–<15mg/100mL	≥15mg/100mL

(continued)

Adverse event	Grade				
	0	1	2	3	4
GGT	WNL	>ULN-2.5 x ULN	>2.5-5.0 x ULN	>5.0-20.0 x ULN	>20.0 x ULN
Hepatic enlargement	Absent	-	-	Present	-
Note: grade hepatic enlargement only for treatment-related adverse event, including VOD					
Hypoalbuminemia	WNL	<LLN-3g/dL	≥2-<3g/dL	<2g/dL	-
Liver dysfunction/failure (clinical)	Normal	-	-	Asterixis	Encephalopathy or coma
Portal vein flow	Normal	-	Decreased portal vein flow	Reversal/retrograde portal vein flow	-
SGOT (aspartate aminotransferase, AST) (serum glutamic oxaloacetic transaminase)	WNL	>ULN-2.5 x ULN	>2.5-5.0 x ULN	>5.0-20.0 x ULN	>20.0 x ULN
SGPT (alanine aminotransferase, ALT) (serum glutamic pyruvic transaminase)	WNL	>ULN-2.5 x ULN	>2.5-5.0 x ULN	>5.0-20.0 x ULN	>20.0 x ULN
Hepatic—Other (specify, _____)	None	Mild	Moderate	Severe	Life-threatening or disabling

**INFECTION/FEBRILE NEUTROPENIA**

Catheter-related infection	None	Mild, no active treatment	Moderate, localized infection, requiring local or oral treatment	Severe, systemic infection, requiring IV antibiotic or antifungal treatment, or hospitalization	Life-threatening sepsis (e.g. septic shock)
Febrile neutropenia (fever of unknown origin without clinically or microbiologically documented infection)	None	—	—	Present	Life-threatening sepsis (e.g. septic shock)

(ANC  $<1.0 \times 10^9/L$ , fever  $\geq 38.5^\circ C$ )

Also consider Neutrophils

Note: hypothermia, instead of fever, may be associated with neutropenia and is graded here

Infection (documented clinically or microbiologically) with grade 3 or 4 neutropenia	None	—	—	Present	Life-threatening sepsis (e.g. septic shock)
(ANC $<1.0 \times 10^9/L$ )					

Also consider Neutrophils

Notes: hypothermia, instead of fever, may be associated with neutropenia and is graded here

In the absence of documented infection, grade 3 or 4 neutropenia with fever is graded as Febrile neutropenia

Infection with unknown ANC	None	—	—	Present	Life-threatening sepsis (e.g. septic shock)
----------------------------	------	---	---	---------	---

Note: this adverse event criterion is used in the rare case when ANC is unknown

(continued)

	Grade				
	0	1	2	3	4
<b>Adverse event</b>					
Infection without neutropenia	None	Mild, no active treatment	Moderate, localized infection, requiring local or oral treatment	Severe, systematic infection, requiring IV antibiotic or antifungal treatment, or hospitalization	Life-threatening sepsis (e.g. septic shock)
Also consider Neutrophils					
Wound infections are graded in the DERMATOLOGY/SKIN category					
Infection/febrile neutropenia—Other (specify: _____)	None	Mild	Moderate	Severe	Life-threatening or disabling
<b>LYMPHATICS</b>					
Lymphatics	Normal	Mild lymphoedema	Moderate lymphoedema, requiring compression; lymphocyst	Severe lymphoedema limiting function; lymphocyst requiring surgery	Severe lymphoedema limiting function, with ulceration
Lymphatics—Other (specify: _____)	None	Mild	Moderate	Severe	Life-threatening or disabling
<b>METABOLIC/LABORATORY</b>					
Acidosis (metabolic or respiratory)	Normal	pH < normal, but ≥7.3	—	pH <7.3	pH <7.3, with life-threatening physiological consequences

Alkalosis (metabolic or respiratory)	Normal	pH > normal, but ≤7.5	–	pH >7.5	pH >7.5, with life-threatening physiological consequences
Amylase	WNL	>ULN–1.5 × ULN	>1.5–2.0 × ULN	>2.0–5.0 × ULN	>5.0 × ULN
Bicarbonate	WNL	<LLN–16mEq/dL	11–15mEq/dL	8–10mEq/dL	<8mEq/dL
CPK (creatine phosphokinase)	WNL	>ULN–2.5 × ULN	>2.5–5 × ULN	>5–10 × ULN	>10 × ULN
Hypercalcaemia	WNL	>ULN–11.5mg/dL	>11.5–12.5mg/dL	>12.5–13.5mg/dL	>13.5mg/dL
		>ULN–2.9mmol/L	>2.9–3.1mmol/L	>3.1–3.4mmol/L	>3.4mmol/L
Hypercholesterolaemia	WNL	>ULN–300mg/dL	>300–400mg/dL	>400–500mg/dL	>500mg/dL
		>ULN–7.75mmol/L	>7.75–10.34mmol/L	>10.34–12.92mmol/L	>12.92mmol/L
Hyperglycaemia	WNL	>ULN–160mg/dL	>160–250mg/dL	>250–500mg/dL	>500mg/dL
		>ULN–8.9mmol/L	>8.9–13.9mmol/L	>13.9–27.8mmol/L	>27.8mmol/L or acidosis
Hyperkalaemia	WNL	>ULN–5.5mmol/L	>5.5–6.0mmol/L	>6.0–7.0mmol/L	>7.0mmol/L
Hypermagnesaemia	WNL	>ULN–3.0mg/dL	–	>3.0–8.0mg/dL	>8.0mg/dL
		>ULN–1.23mmol/L		>1.23–3.30mmol/L	>3.30mmol/L
Hypernatraemia	WNL	>ULN–150mmol/L	>150–155mmol/L	>155–160mmol/L	>160mmol/L
Hypertnglyceridaemia	WNL	>ULN–2.5 × ULN	>2.5–5.0 × ULN	>5.0–10 × ULN	>10 × ULN

(continued)

Adverse event	Grade				
	0	1	2	3	4
Hyperuricaemia	WNL	>ULN-<10mg/dL ≤0.59mmol/L without physiological consequences	-	>ULN-<10mg/dL ≤0.59mmol/L with physiological consequences	>10mg/dL >0.59mmol/L
Also consider Tumour lysis syndrome, Renal failure, Creatinine, Hyperkalaemia					
Hypocalcaemia	WNL	<LLN-8.0mg/dL	7.0-<8.0mg/dL	6.0-<7.0mg/dL	<6.0mg/dL
Hypoglycaemia	WNL	<LLN-2.0mmol/L	1.75-<2.0mmol/L	1.5-<1.75mmol/L	<1.5mmol/L
	WNL	<LLN-55mg/dL	40-<55mg/dL	30-<40mg/dL	<30mg/dL
Hypokalaemia	WNL	<LLN-3.0mmol/L	2.2-<3.0mmol/L	1.7-<2.2mmol/L	<1.7mmol/L
	WNL	<LLN-3.0mmol/L	-	2.5-<3.0mmol/L	<2.5mmol/L
Hypomagnesaemia	WNL	<LLN-1.2mg/dL	0.9-<1.2mg/dL	0.7-<0.9mg/dL	<0.7mg/dL
	WNL	<LLN-0.5mmol/L	0.4-<0.5mmol/L	0.3-<0.4mmol/L	<0.3mmol/L
Hyponatraemia	WNL	<LLN-130mmol/L	-	120-<130mmol/L	<120mmol/L
Hypophosphataemia	WNL	<LLN-2.5mg/dL	≥2.0-<2.5mg/dL	≥1.0-<2.0mg/dL	<1.0mg/dL
	WNL	<LLN-0.8mmol/L	≥0.6-<0.8mmol/L	≥0.3-<0.6mmol/L	<0.3mmol/L
Hypothyroidism is graded in the ENDOCRINE category					
Lipase	WNL	>ULN-1.5 × ULN	>1.5-2.0 × ULN	>2.0-5.0 × ULN	>5.0 × ULN



	None	Mild	Moderate	Severe	Life-threatening or disabling
Metabolic/ laboratory—Other (specify, _____)					
<b>MUSCULOSKELETAL</b>					
Arthralgia is graded in the PAIN category					
Arthritis	None	Mild pain, with inflammation, erythema, or joint swelling, but not interfering with function	Moderate pain, with inflammation, erythema, or joint swelling interfering with function, but not interfering with activities of daily living	Severe pain, with inflammation, erythema, or joint swelling and interfering with activities of daily living	Disabling
Muscle weakness normal (not due to neuropathy)	Normal	Asymptomatic, with weakness on physical exam	Symptomatic and interfering with function, but not interfering with activities of daily living	Symptomatic and interfering with activities of daily living	Bedridden or disabling
Myalgia (tenderness or pain in muscles) is graded in the PAIN category					
Myositis (inflammation/ damage of muscle)	None	Mild pain, not interfering with function	Pain, interfering with function, but not interfering with activities of daily living	Pain, interfering with function and interfering with activities of daily living	Bedridden or disabling
Also consider CPK					
Note: myositis implies muscle damage (i.e. elevated CPK)					

(continued)

Adverse event	Grade				
	0	1	2	3	4
Osteonecrosis (avascular necrosis)	None	Asymptomatic and detected by imaging only	Symptomatic and interfering with function, but not interfering with activities of daily living	Symptomatic and interfering with activities of daily living	Symptomatic; or disabling
Musculoskeletal—Other (specify, _____)	None	Mild	Moderate	Severe	Life-threatening or disabling
<b>NEUROLOGY</b>					
Aphasia, receptive and/or expressive, is graded under Speech impairment in the NEUROLOGY category					
Arachnoiditis/meningismus/radiculitis	Absent	Mild pain, not interfering with function	Moderate pain, interfering with function, but not interfering with activities of daily living	Severe pain, interfering with activities of daily living	Unable to function or perform activities of daily living; bedridden; paraplegia
Also consider Headache, Vomiting, Fever					
Ataxia (incoordination)	Normal	Asymptomatic, but abnormal on physical exam, and not interfering with function	Mild symptoms, interfering with function, but not interfering with activities of daily living	Moderate symptoms, interfering with activities of daily living	Bedridden or disabling
CNS cerebrovascular ischaemia	None	—	—	Transient ischaemic event or attack (TIA)	Permanent event (e.g. CVA)
CNS haemorrhage/bleeding is graded in the HAEMORRHAGE category					

Cognitive disturbance/ learning problems	None	Cognitive disability; not interfering with work/school performance; preservation of intelligence	Cognitive disability; interfering with work/school performance; decline of 1 standard deviation (SD) or loss of developmental milestones	Cognitive disability; resulting in significant impairment of work/school performance; cognitive decline >2 SD	Inability to work/frank mental retardation
Confusion	Normal	Confusion or disorientation or attention deficit of brief duration; resolves spontaneously with no sequelae	Confusion or disorientation or attention deficit, interfering with function, but not interfering with activities of daily living	Confusion or delirium, interfering with activities of daily living	Harmful to others or self; requiring hospitalization
Cranial neuropathy is graded in the NEUROLOGY category as Neuropathy—cranial					
Delusions	Normal	—	—	Present	Toxic psychosis
Depressed level of consciousness	Normal	Somnolence or sedation, not interfering with function	Somnolence or sedation, interfering with function, but not interfering with activities of daily living	Obtundation or stupor; difficult to arouse; interfering with activities of daily living	Coma
Note: syncope (fainting) is graded in the NEUROLOGY category					
Dizziness/ light-headedness	None	Not interfering with function	Interfering with function, but not interfering with activities of daily living	Interfering with activities of daily living	Bedridden or disabling
Dysphasia, receptive and/or expressive, is graded under Speech impairment in the NEUROLOGY category					

(continued)

Adverse event	Grade			
	0	1	2	3
Extrapyramidal/ involuntary movement/ restlessness	None	Mild involuntary movements, not interfering with function	Moderate involuntary movements, interfering with function, but not interfering with activities of daily living	Severe involuntary movements or torticollis, interfering with activities of daily living
Hallucinations	Normal	–	–	Present
Headache is graded in the PAIN category	–	–	–	Toxic psychosis
Insomnia	Normal	Occasional difficulty sleeping, not interfering with function	Difficulty sleeping, interfering with function, but not interfering with activities of daily living	Frequent difficulty sleeping, interfering with activities of daily living
Note: this adverse event is graded when insomnia is related to treatment. If pain or other symptoms interfere with sleep, do not grade as Insomnia				
Irritability (children <3y of age)	Normal	Mild; easily consolable	Moderate; requiring increased attention	Severe; inconsolable
Leucoencephalopathy associated radiological findings	None	Mild increase in subarachnoid space (SAS); and/or mild ventriculomegaly; and/or small ( $\pm$ multiple) focal T2 hyperintensities, involving periventricular white matter or <1/3 of susceptible areas of cerebrum	Moderate increase in SAS; and/or moderate ventriculomegaly; and/or focal T2 hyperintensities extending into centrum ovale; or involving 1/3–2/3 of susceptible areas of cerebrum	Severe increase in SAS; severe ventriculomegaly; diffuse low attenuation with calcification (CT); diffuse white matter necrosis (MRI)

Memory loss	Normal	Memory loss, not interfering with function	Memory loss, interfering with function, but not interfering with activities of daily living	Memory loss, interfering with activities of daily living	Amnesia
Mood alteration— <i>anxiety, agitation</i>	Normal	Mild mood alteration, not interfering with function	Moderate mood alteration, interfering with function, but not interfering with activities of daily living	Severe mood alteration, interfering with activities of daily living	Suicidal ideation or danger to self
Mood alteration— <i>depression</i>	Normal	Mild mood alteration, not interfering with function	Moderate mood alteration, interfering with function, but not interfering with activities of daily living	Severe mood alteration, interfering with activities of daily living	Suicidal ideation or danger to self
Mood alteration— <i>euphoria</i>	Normal	Mild mood alteration, not interfering with function	Moderate mood alteration, interfering with function, but not interfering with activities of daily living	Severe mood alteration, interfering with activities of daily living	Danger to self
Neuropathic pain is graded in the PAIN category					
Neuropathy— <i>cranial</i>	Absent	–	Present, not interfering with activities of daily living	Present, interfering with activities of daily living	Life-threatening, disabling
Neuropathy— <i>motor</i>	Normal	Subjective weakness, but no objective findings	Mild objective weakness, interfering with function, but not interfering with activities of daily living	Objective weakness, interfering with activities of daily living	Paralysis

(continued)

Adverse event	Grade				
	0	1	2	3	4
Neuropathy—sensory	Normal	Loss of deep tendon reflexes or paraesthesiae (including tingling), but not interfering with function	Objective sensory loss or paraesthesiae (including tingling), interfering with function, but not interfering with activities of daily living	Sensory loss or paraesthesiae interfering with activities of daily living	Permanent sensory loss that interferes with function
Nystagmus	Absent	Present	—	—	Toxic psychosis
Also consider Vision—double vision					
Personality/behavioural	Normal	Change, but not disruptive to patient or family	Disruptive to patient or family	Disruptive to patient and family; requiring mental health intervention	Harmful to others or self; requiring hospitalization
Pyramidal tract dysfunction (e.g. tone, hyperreflexia, positive Babinski, fine motor coordination)	Normal	Asymptomatic, with abnormality on physical examination	Symptomatic or interfering with function, but not interfering with activities of daily living	Interfering with activities of daily living	Bedridden or disabling; paralysis
Seizure(s)	None	—	Seizure(s) self-limited and consciousness is preserved	Seizure(s) in which consciousness is altered	Seizures of any type that are prolonged, repetitive, or difficult to control (e.g. status epilepticus, intractable epilepsy)
Speech impairment (e.g. dysphasia or aphasia)	Normal	—	Awareness of receptive or expressive dysphasia, not impairing ability to communicate	Receptive or expressive dysphasia, impairing ability to communicate	Inability to communicate

Syncope (fainting) Also consider CARDIOVASCULAR (ARRHYTHMIA), Vasovagal episode, CNS cerebrovascular ischaemia	Absent	—	Present	—
Tremor	None	Mild and brief or intermittent, but not interfering with function	Moderate tremor, interfering with function, but not interfering with activities of daily living	Severe tremor, interfering with activities of daily living
Vertigo	None	Not interfering with function	Interfering with function, but not interfering with activities of daily living	Interfering with activities of daily living Bedridden or disabling
Neurology—Other (specify, _____)	None	Mild	Moderate	Severe
<b>OCULAR/VISUAL</b>				Life-threatening or disabling
Cataract	None	Asymptomatic	Symptomatic, partial visual loss	Symptomatic, visual loss requiring treatment or interfering with function
Conjunctivitis	None	Abnormal ophthalmological changes, but asymptomatic or symptomatic without visual impairment (i.e. pain and irritation)	Symptomatic and interfering with function, but not interfering with activities of daily living	Symptomatic and interfering with activities of daily living

(continued)

Adverse event	Grade				
	0	1	2	3	4
Dry eye	Normal	Mild, not requiring treatment	Moderate or requiring artificial tears	–	–
Glaucoma	None	Increase in intraocular pressure, but no visual loss	Increase in intraocular pressure, with retinal changes	Visual impairment	Unilateral or bilateral loss of vision (blindness)
Keratitis (corneal inflammation/corneal ulceration)	None	Abnormal ophthalmological changes, but asymptomatic or symptomatic, without visual impairment (i.e. pain and irritation)	Symptomatic and interfering with function, but not interfering with activities of daily living	Symptomatic and interfering with activities of daily living	Unilateral or bilateral loss of vision (blindness)
Tearing (watery eyes)	None	Mild: not interfering with function	Moderate: interfering with function, but not interfering with activities of daily living	Interfering with activities of daily living	–
Vision—blurred vision	Normal	–	Symptomatic and interfering with function, but not interfering with activities of daily living	Symptomatic and interfering with activities of daily living	–
Vision—double vision (diplopia)	Normal	–	Symptomatic and interfering with function, but not interfering with activities of daily living	Symptomatic and interfering with activities of daily living	–



Vision—flashing lights/ floaters	Normal	Mild, not interfering with function	Symptomatic and interfering with function, but not interfering with activities of daily living	Symptomatic and interfering with activities of daily living	—
Vision—night blindness (nyctalopia)	Normal	Abnormal electroretinography, but asymptomatic	Symptomatic and interfering with function, but not interfering with activities of daily living	Symptomatic and interfering with activities of daily living	—
Vision—photophobia	Normal	—	Symptomatic and interfering with function, but not interfering with activities of daily living	Symptomatic and interfering with activities of daily living	—
Ocular/Visual—Other (specify: _____)	Normal	Mild	Moderate	Severe	Unilateral or bilateral loss of vision
<b>PAIN</b>					
Abdominal pain or cramping	None	Mild pain, not interfering with function	Moderate pain: pain or analgesics interfering with function, but not interfering with activities of daily living	Severe pain: pain or analgesics severely interfering with activities of daily living	Disabling
Arthralgia (joint pain)	None	Mild pain, not interfering with function	Moderate pain: pain or analgesics interfering with function, but not interfering with activities of daily living	Severe pain: pain or analgesics severely interfering with activities of daily living	Disabling

(continued)

Adverse event	Grade				
	0	1	2	3	4
Arthritis (joint pain with clinical signs of inflammation) is graded in the MUSCULOSKELETAL category					
Bone pain	None	Mild pain, not interfering with function	Moderate pain: pain or analgesics interfering with function, but not interfering with activities of daily living	Severe pain: pain or analgesics severely interfering with activities of daily living	Disabling
Chest pain (non-cardiac and non-pleuritic)	None	Mild pain, not interfering with function	Moderate pain: pain or analgesics interfering with function, but not interfering with activities of daily living	Severe pain: pain or analgesics severely interfering with activities of daily living	Disabling
Dysmenorrhoea	None	Mild pain, not interfering with function	Moderate pain: pain or analgesics interfering with function, but not interfering with activities of daily living	Severe pain: pain or analgesics severely interfering with activities of daily living	Disabling
Dyspareunia	None	Mild pain, not interfering with function	Moderate pain, interfering with sexual activity	Severe pain, preventing sexual activity	–
Dysuria is graded in the RENAL/GENITOURINARY category					
Earache (otalgia)	None	Mild pain, not interfering with function	Moderate pain: pain or analgesics interfering with function, but not interfering with activities of daily living	Severe pain: pain or analgesics severely interfering with activities of daily living	Disabling

Headache	None	Mild pain, not interfering with function	Moderate pain: pain or analgesics interfering with activities of daily living	Severe pain: pain or analgesics severely interfering with activities of daily living	Disabling
Hepatic pain	None	Mild pain, not interfering with function	Moderate pain: pain or analgesics interfering with function, but not interfering with activities of daily living	Severe pain: pain or analgesics severely interfering with activities of daily living	Disabling
Myalgia (muscle pain)	None	Mild pain, not interfering with function	Moderate pain: pain or analgesics interfering with activities of daily living	Severe pain: pain or analgesics severely interfering with activities of daily living	Disabling
Neuropathic pain (e.g. jaw pain, neurological pain, phantom limb pain, post-infectious neuralgia, or painful neuropathies)	None	Mild pain, not interfering with function	Moderate pain: pain or analgesics interfering with function, but not interfering with activities of daily living	Severe pain: pain or analgesics severely interfering with activities of daily living	Disabling
Pain due to radiation	None	Mild pain, not interfering with function	Moderate pain: pain or analgesics interfering with activities of daily living	Severe pain: pain or analgesics severely interfering with activities of daily living	Disabling
Pelvic pain	None	Mild pain, not interfering with function	Moderate pain: pain or analgesics interfering with function, but not interfering with activities of daily living	Severe pain: pain or analgesics severely interfering with activities of daily living	Disabling

(continued)

Adverse event	Grade				
	0	1	2	3	4
Pleuritic pain	None	Mild pain, not interfering with function	Moderate pain; pain or analgesics interfering with function, but not interfering with activities of daily living	Severe pain; pain or analgesics severely interfering with activities of daily living	Disabling
Rectal or perirectal pain (proctalgia)	None	Mild pain, not interfering with function	Moderate pain; pain or analgesics interfering with function, but not interfering with activities of daily living	Severe pain; pain or analgesics severely interfering with activities of daily living	Disabling
Tumour pain (onset or exacerbation of tumour pain due to treatment)	None	Mild pain, not interfering with function	Moderate pain; pain or analgesics interfering with function, but not interfering with activities of daily living	Severe pain; pain or analgesics severely interfering with activities of daily living	Disabling
Tumour flare is graded in the SYNDROME category					
Pain—Other (specify, _____)	None	Mild	Moderate	Severe	Disabling
<b>PULMONARY</b>					
Adult respiratory distress syndrome (ARDS)	Absent	—	—	—	Present
Apnoea	None	—	—	Present	Requiring intubation
Carbon monoxide diffusion capacity ( $DL_{CO}$ )	$\geq 90\%$ of pre-treatment or normal value	$\geq 75\text{--}<90\%$ of pre-treatment or normal value	$\geq 50\text{--}<75\%$ of pre-treatment or normal value	$\geq 25\text{--}<50\%$ of pre-treatment or normal value	$<25\%$ of pre-treatment or normal value

Cough	Absent	Mild, relieved by non-prescription medication	Requiring narcotic antitussive	Severe cough or coughing spasms, poorly controlled or unresponsive to treatment	–
Dyspnoea (shortness of breath)	Normal	–	Dyspnoea on exertion	Dyspnoea at normal level of activity	Dyspnoea at rest or requiring ventilator support
Forced expiratory volume in 1s (FEV <sub>1</sub> )	≥90% of pre-treatment or normal value	≥75–<90% of pre-treatment or normal value	≥50–<75% of pre-treatment or normal value	≥25–<50% of pre-treatment or normal value	<25% of pre-treatment or normal value
Hiccoughs (hiccup, singultus)	None	Mild, not requiring treatment	Moderate, requiring treatment	Severe, prolonged, and refractory to treatment	–
Hypoxia	Normal	–	Decreased O <sub>2</sub> saturation with exercise	Decreased O <sub>2</sub> saturation at rest, requiring supplemental O <sub>2</sub>	Decreased O <sub>2</sub> saturation, requiring pressure support (continuous positive airway pressure, CPAP) or assisted ventilation
Pleural effusion (non-malignant)	None	Asymptomatic and not requiring treatment	Symptomatic, requiring diuretics	Symptomatic, requiring O <sub>2</sub> or therapeutic thoracentesis	Life-threatening (e.g. requiring intubation)
Pleuritic pain is graded in the PAIN category					
Pneumonitis/pulmonary infiltrates	None	Radiographic changes, but asymptomatic or symptoms not requiring steroids	Radiographic changes and requiring steroids or diuretics	Radiographic changes and requiring O <sub>2</sub>	Radiographic changes and requiring assisted ventilation

(continued)

Adverse event	Grade				
	0	1	2	3	4
Pneumothorax	None	No intervention required	Chest tube required	Sclerosis or surgery required	Life-threatening
PE is graded as Thrombosis/embolism in the <b>CARDIOVASCULAR (GENERAL)</b> category					
Pulmonary fibrosis	None	Radiographic changes, but asymptomatic or symptoms not requiring steroids	Requiring steroids or diuretics	Requiring O <sub>2</sub>	Requiring assisted ventilation
Note: radiation-related pulmonary fibrosis is graded in the RTOG/EORTC late radiation morbidity scoring scheme—lung (see <b>➔</b> RTOG/EORTC late radiation morbidity scoring scheme, p. 844)					
Voice changes/stridor/larynx (e.g. hoarseness, loss of voice, laryngitis)	Normal	Mild or intermittent hoarseness	Persistent hoarseness, but able to vocalize; may have mild to moderate oedema	Whispered speech, not able to vocalize; may have marked oedema	Marked dyspnoea/stridor requiring tracheostomy or intubation
Notes: cough from radiation is graded as Cough in the <b>PULMONARY</b> category					
Radiation-related haemoptysis from larynx/pharynx is graded as Grade 4 mucositis due to radiation in the <b>GASTROINTESTINAL</b> category;					
radiation-related haemoptysis from the thoracic cavity is graded as Grade 4 haemoptysis in the <b>HAEMORRHAGE</b> category					
Pulmonary—Other (specify, _____)	None	Mild	Moderate	Severe	Life-threatening or disabling
<b>RENAL/GENITOURINARY</b>					
Bladder spasms	Absent	Mild symptoms, not requiring intervention	Symptoms requiring antispasmodic	Severe symptoms requiring narcotic	—

Creatinine	WNIL	>ULN-1.5	ULN >1.5-3.0 × ULN	>3.0-6.0 × ULN	>6.0 × ULN
<i>Note: adjust to age-appropriate levels for paediatric patients</i>					
Dysuria (painful urination)	None	Mild symptoms requiring no intervention	Symptoms relieved with therapy	Symptoms not relieved, despite therapy	–
Fistula or genitourinary fistula (e.g. vaginal, vesicovaginal)	None	–	–	Requiring intervention	Requiring surgery
Haemoglobinuria	–	Present	–	–	–
Haematuria (in the absence of vaginal bleeding) is graded in the HAEMORRHAGE category					
Incontinence	None	With coughing, sneezing, etc.	Spontaneous, some control	No control (in the absence of fistula)	–
Operative injury to bladder and/or ureter	None	–	Injury of bladder with 1° repair	Sepsis, fistula, or obstruction requiring 2° surgery; loss of one kidney; injury requiring anastomosis or re-implantation	Septic obstruction of both kidneys or vesicovaginal fistula requiring diversion
Proteinuria	Normal or <0.15g/24h	1+ or 0.15-1.0g/24h	2+ to 3+ or 1.0-3.5g/24h	4+ or >3.5g/24h	Nephrotic syndrome
<i>Note: if there is an inconsistency between the absolute value and dipstick reading, use the absolute value for grading</i>					
Renal failure	None	–	–	Requiring dialysis, but reversible	Requiring dialysis and irreversible

(continued)

Adverse event	Grade				
	0	1	2	3	4
Ureteral obstruction	None	Unilateral, not requiring surgery	–	Bilateral, not requiring surgery	Stent, nephrostomy tube, or surgery
Urinary electrolyte wasting (e.g. Fanconi's syndrome, renal tubular acidosis)	None	Asymptomatic, not requiring treatment	Mild, reversible, and manageable with oral replacement	Reversible, but requiring IV replacement	Irreversible, requiring continued replacement
Also consider Acidosis, Bicarbonate, Hypocalcaemia, Hypophosphataemia					
Urinary frequency/urgency	Normal	Increase in frequency or nocturia up to 2 x normal	Increase >2 x normal, but < hourly	Hourly or more, with urgency or requiring catheter	–
Urinary retention	Normal	Hesitancy or dribbling, but no significant residual urine; retention occurring during the immediate post-operative period	Hesitancy requiring medication or occasional in/out catheterization (<4 x per week), or operative bladder atony requiring indwelling catheter beyond immediate post-operative period, but for <6wk	Requiring frequent in/out catheterization ( $\geq 4$ x per week) or urological intervention (e.g. TURP, suprapubic tube, urethrotomy)	Bladder rupture
Urine colour change (not related to other dietary or physiological cause, e.g. bilirubin, concentrated urine, haematuria)	Normal	Asymptomatic, change in urine colour	–	–	–



Vaginal bleeding is graded in the HAEMORRHAGE category			
Vaginitis (not due to infection)	None	Mild, not requiring treatment	Moderate, relieved with treatment
Renal/genitourinary—Other (specify, _____)	None	Mild	Moderate
2° MALIGNANCY			
2° malignancy—Other (specify type, _____); excludes metastasis from initial 1°	None	—	—
			Severe, not relieved with treatment, or ulceration not requiring surgery
			Severe
			Life-threatening or disabling
			Ulceration requiring surgery
			Present
SEXUAL/REPRODUCTIVE FUNCTION			
Dyspareunia is graded in the PAIN category			
Dysmenorrhoea is graded in the PAIN category			
Erectile impotence	Normal	Mild (erections impaired, but satisfactory)	Moderate (erections impaired, unsatisfactory for intercourse)
			No erections
Female sterility	Normal	—	Sterile
Feminization of the ♂ is graded in the ENDOCRINE category			

(continued)

Adverse event	Grade				
	0	1	2	3	4
Irregular menses (change from baseline)	Normal	Occasionally irregular or lengthened interval, but continuing menstrual cycles	Very irregular, but continuing menstrual cycles	Persistent amenorrhoea	—
Libido	Normal	Decrease in interest	Severe loss of interest	—	—
♂ infertility	—	—	Oligospermia (low sperm count)	Azoospermia (no sperm)	—
Masculinization of the ♀ is graded in the ENDOCRINE category					
Vaginal dryness	Normal	Mild	Requiring treatment and/or interfering with sexual function, dyspareunia	—	—
Sexual/reproductive function—Other (specify, _____)	None	Mild	Moderate	Severe	Disabling
<b>SYNDROMES (not included in previous categories)</b>					
Acute vascular leak syndrome is graded in the <b>CARDIOVASCULAR (GENERAL)</b> category					
ARDS is graded in the <b>PULMONARY</b> category					
Autoimmune reactions are graded in the <b>ALLERGY/IMMUNOLOGY</b> category					
DIC is graded in the <b>COAGULATION</b> category					

Adverse event	Grade				
	0	1	2	3	4
Fanconi's syndrome is graded as Urinary electrolyte wasting in the RENAL/GENITOURINARY category					
Renal tubular acidosis is graded as Urinary electrolyte wasting in the RENAL/GENITOURINARY category					
Stevens-Johnson syndrome (erythema multiforme) is graded in the DERMATOLOGY/SKIN category					
SIADH is graded in the ENDOCRINE category					
Thrombotic microangiopathy (e.g. TTP or HUS) is graded in the COAGULATION category					
Tumour flare	None	Mild pain, not interfering with function	Moderate pain; pain or analgesics interfering with function, but not interfering with activities of daily living	Severe pain; pain or analgesics interfering with function and interfering with activities of daily living	Disabling
Also consider Hypercalcaemia					
Note: tumour flare is characterized by a constellation of symptoms and signs in direct relation to initiation of therapy (e.g. anti-oestrogens/androgens or additional hormones). The symptoms/signs include tumour pain, inflammation of visible tumour, hypercalcaemia, diffuse bone pain, and other electrolyte disturbances					
Tumour lysis syndrome	Absent	–	–	Present	–
Also consider Hyperkalaemia, Creatinine					
Urinary electrolyte wasting (e.g. Fanconi's syndrome, renal tubular acidosis) is graded in the RENAL/GENITOURINARY category					
Syndromes—Other (specify, _____)	None	Mild	Moderate	Severe	Life-threatening or disabling

## Adverse event module

To be implemented at the request of the study sponsor or principal investigator in the protocol or by protocol amendment when more detailed information is considered pertinent.

Adverse event:	Date of treatment:	Course number:
Date of onset: .....		Grade at onset: .....
Date of first change in grade: .....		Grade: .....
Date of next change in grade: .....		Grade: .....
Date of next change in grade: .....		Grade: .....
Date of next change in grade: .....		Grade: .....
Date of next change in grade: .....		Grade: .....
Date of next change in grade: .....		Grade: .....
Did adverse event resolve? Yes_____ No_____		
If so, date of resolution of adverse event: .....		
Date of last observation (if prior to recovery): .....		
Reason(s) observations stopped (if prior to recovery): .....		
Was patient retreated? Yes_____ No_____		
If yes, was treatment delayed for recovery? Date of next treatment? Yes_____ No_____		
Dose reduced for next treatment? Yes_____ No_____		
Additional comments: .....		
.....		
.....		
.....		
If module is being activated for new adverse event not currently in CTC, please provide definitions for adverse event grading:		
Grade 0 = .....		
Grade 1 = .....		
Grade 2 = .....		
Grade 3 = .....		
Grade 4 = .....		

## Infection module

To be implemented at the request of the study sponsor or principal investigator in the protocol or by protocol amendment when more detailed information is considered pertinent.

1. Use the CTC definitions to grade the severity of the infection.
2. Specify type of infection from the following (CHOOSE ONE):  
BACTERIAL FUNGAL PROTOZOAL VIRAL UNKNOWN
3. Specify site of infection from the following (CHOOSE ALL THAT APPLY):

BLOOD CULTURE POSITIVE

BONE INFECTION

CATHETER (intravenous)

CATHETER (intravenous), tunnel infection

CENTRAL NERVOUS SYSTEM INFECTION

EAR INFECTION

EYE INFECTION

GASTROINTESTINAL INFECTION

ORAL INFECTION

PNEUMONIA

SKIN INFECTION

UPPER RESPIRATORY INFECTION

URINARY TRACT INFECTION

VAGINAL INFECTION

INFECTION, not otherwise specified (specify site: \_\_\_\_\_)

4. Specify organism, if known: \_\_\_\_\_.
5. Prophylactic antibiotic, antifungal, or antiviral therapy administration

Yes \_\_\_\_\_ No \_\_\_\_\_

If prophylaxis was given prior to infection, please specify below:

Antibiotic prophylaxis \_\_\_\_\_

Antifungal prophylaxis \_\_\_\_\_

Antiviral prophylaxis \_\_\_\_\_

Other prophylaxis \_\_\_\_\_

## Performance status scales/scores

### Performance status criteria

Karnofsky and Lansky performance scores are intended to be multiples of ten.

ECOG (Zubrod)		Karnofsky		Lansky*	
Score	Description	Score	Description	Score	Description
0	Fully active, able to carry on all pre-disease performance without restriction	100	Normal, no complaints, no evidence of disease	100	Fully active, normal
		90	Able to carry on normal activity; minor signs or symptoms of disease	90	Minor restrictions in physically strenuous activity
1	Restricted in physically strenuous activity, but ambulatory and able to carry out work of a light or sedentary nature, e.g. light housework, office work	80	Normal activity with effort; some signs or symptoms of disease	80	Active, but tires more quickly
		70	Cares for self, unable to carry on normal activity or do active work	70	Both greater restriction of, and less time spent in, play activity

2	Ambulatory and capable of all self-care, but unable to carry out any work activities. Up and about >50% of waking hours	60	Requires occasional assistance, but is able to care for most of his/her needs	60	Up and around, but minimal active play; keeps busy with quieter activities
		50	Requires considerable assistance and frequent medical care	50	Gets dressed, but lies around much of the day; no active play; able to participate in all quiet play and activities
3	Capable of only limited self-care, confined to bed or chair >50% of waking hours	40	Disabled, requires special care and assistance	40	Mostly in bed; participates in quiet activities
		30	Severely disabled, hospitalization indicated. Death not imminent	30	In bed; needs assistance, even for quiet play
4	Completely disabled. Cannot carry on any self-care. Totally confined to bed or chair	20	Very sick, hospitalization indicated. Death not imminent	20	Often sleeping; play entirely limited to very passive activities
		10	Moribund, fatal processes progressing rapidly	10	No play; does not get out of bed

\* The conversion of the Lansky to ECOG scales is intended for National Cancer Institute (NCI) reporting purposes only. ECOG, Eastern Cooperative Oncology Group; RTOG, Radiation Therapy Oncology Group.

## RTOG/EORTC late radiation morbidity scoring scheme

Use for adverse event occurring >90 days after radiation therapy.

Adverse event	Grade			
	0	1	2	3
Bladder—late RT morbidity scoring	No change from baseline	Slight epithelial atrophy/minor telangiectasia (microscopic haematuria)	Moderate frequency/generalized telangiectasia/intermittent macroscopic haematuria	Severe frequency and dysuria/severe generalized telangiectasia (often with petechiae); frequent haematuria; reduction in bladder capacity (<150mL)
Bone—late RT morbidity scoring	No change from baseline	Asymptomatic; no growth retardation; reduced bone density	Moderate pain or tenderness; growth retardation; irregular bone sclerosis	Severe pain or tenderness; complete arrest of bone growth; dense bone sclerosis
Brain—late RT morbidity scoring	No change from baseline	Mild headache; slight lethargy	Moderate headache; great lethargy	Severe headaches; severe CNS dysfunction (partial loss of power or dyskinesia)
Oesophagus—late RT morbidity scoring	No change from baseline	Mild fibrosis; slight difficulty in swallowing solids; no pain on swallowing	Unable to take solid food normally; swallowing semi-solid food; dilation may be indicated	Severe fibrosis; able to swallow only liquids; may have pain on swallowing; dilation required
Eye—late RT morbidity scoring	No change from baseline	Asymptomatic cataract; minor corneal ulceration or keratitis	Symptomatic cataract; moderate corneal ulceration; minor retinopathy or glaucoma	Severe keratitis; severe retinopathy or detachment; severe glaucoma
				Necrosis/contracted bladder (capacity <100mL/severe haemorrhagic cystitis)
				Necrosis/spontaneous fracture
				Seizures or paralysis; coma
				Necrosis/perforation; fistula
				Panophthalmitis; blindness



Heart—late RT morbidity scoring	No change from baseline	Asymptomatic or mild symptoms; transient T-wave inversion and ST changes; sinus tachycardia >110 (at rest)	Moderate angina on effort; mild pericarditis; normal heart size; persistent abnormal T-wave and ST changes; low QRS	Severe angina; pericardial effusion; constrictive pericarditis; moderate heart failure; cardiac enlargement; ECG abnormalities	Tamponade/ severe heart failure/ severe constrictive pericarditis
Joint—late RT morbidity scoring	No change from baseline	Mild joint stiffness; slight limitation of movement	Moderate stiffness; intermittent or moderate joint pain; moderate limitation of movement	Severe joint stiffness; pain with severe limitation of movement	Necrosis/complete fixation
Larynx—late RT morbidity scoring	No change from baseline	Transient albuminuria; no hypertension; mild impairment of renal function; urea 25–35mg/dL; creatinine 1.5–2.0 mg/dL; creatinine clearance >75%	Persistent moderate albuminuria (2+); mild hypertension; no related anaemia; moderate impairment of renal function; urea >36–60mg/dL; creatinine clearance >50–74%	Severe albuminuria; severe hypertension; persistent anaemia (<10g/dL); severe renal failure; urea >60mg/dL; creatinine >4mg/dL; creatinine clearance <50%	Malignant hypertension; uraemic coma/urea >100%
Liver—late RT morbidity scoring	No change from baseline	Hoarseness; slight arytenoid oedema	Moderate arytenoid oedema; chondritis	Severe oedema; severe chondritis	Necrosis
	No change from baseline	Mild lassitude; nausea; dyspepsia; slightly abnormal liver function	Moderate symptoms; some abnormal liver function tests; serum albumin normal	Disabling hepatic insufficiency; LFTs grossly abnormal; low albumin; oedema or ascites	Necrosis/ hepatic coma or encephalopathy

(continued)

Adverse event	Grade				
	0	1	2	3	4
Lung—late RT morbidity scoring	No change from baseline	Asymptomatic or mild symptoms (dry cough); slight radiographic appearances	Moderate symptomatic fibrosis or pneumonitis (severe cough); low-grade fever; patchy radiographic appearances	Severe symptomatic fibrosis or pneumonitis; dense radiographic changes	Severe respiratory insufficiency/continuous O <sub>2</sub> /assisted ventilation
Mucous membrane—late RT morbidity scoring	No change from baseline	Slight atrophy and dryness	Moderate atrophy and telangiectasia; little mucus	Marked atrophy with complete dryness; severe telangiectasia	Ulceration
Salivary glands—late RT morbidity scoring	No change from baseline	Slight dryness of mouth; good response on stimulation	Moderate dryness of mouth; poor response on stimulation	Complete dryness of mouth; no response on stimulation	Fibrosis
Skin—late RT morbidity scoring	No change from baseline	Slight atrophy; pigmentation change; some hair loss	Patchy atrophy; moderate telangiectasia; total hair loss	Marked atrophy; gross telangiectasia	Ulceration
Small/large intestine—late RT morbidity scoring	No change from baseline	Mild diarrhoea; mild cramping; bowel movement >5X daily; slight rectal discharge or bleeding	Moderate diarrhoea and colic; bowel movement >5X daily; excessive rectal mucus or intermittent bleeding	Obstruction or bleeding, requiring surgery	Necrosis/perforation fistula

Spinal cord—late RT morbidity scoring	No change from baseline	Mild Lhermitte's syndrome	Severe Lhermitte's syndrome	Objective neurological findings at or below cord level treatment	Mono-, para-, quadriplegia
Subcutaneous tissue—late RT morbidity scoring	No change from baseline	Slight induration (fibrosis) and loss of subcutaneous fat	Moderate fibrosis, but asymptomatic; slight field contracture; <10% linear reduction	Severe induration and loss of subcutaneous tissue; field contracture; >10% linear measurement	Necrosis
Radiation—Other (specify _____)	None	Mild	Moderate	Severe	Life-threatening or disabling

## Bone marrow transplantation: specific adverse events

Summary of Bone marrow transplantation (BMT)—specific adverse events that may be used, if specified by the protocol. These differ from the standard CTC and may be more relevant to the transplant setting. They are listed here for the convenience of investigators writing transplant protocols. They are also included in the CTC document.

Adverse event	Grade				
	0	1	2	3	4
Bilirubin associated with GVHD for BMT studies	Normal	≥ 2–<3mg/100mL	≥ 3–<6mg/100mL	≥ 6–<15mg/100mL	≥ 15mg/100mL
Diarrhoea associated with GVHD for BMT studies	None	>500–≤1000mL of diarrhoea/day	>1000–≤1500mL of diarrhoea/day	>1500mL of diarrhoea/day	Severe abdominal pain, with or without ileus
Diarrhoea for paediatric BMT studies		>5–≤10mL/kg of diarrhoea/day	>10–≤15mL/kg of diarrhoea/day	>15mL/kg of diarrhoea/day	–
Hepatic enlargement	Absent	–	–	Present	–
Leucocytes (total WCC) for BMT studies	WNL	≥ 2.0–<3.0 × 10 <sup>9</sup> /L	≥ 1.0–<2.0 × 10 <sup>9</sup> /L	≥ 0.5–<1.0 × 10 <sup>9</sup> /L	<0.5 × 10 <sup>9</sup> /L
Leucocytes (total WCC) for paediatric BMT studies (using age, race, and sex normal values)		≥ 2000–<3000/mm <sup>3</sup>	≥ 1000–<2000/mm <sup>3</sup>	≥ 500–<1000/mm <sup>3</sup>	<500/mm <sup>3</sup>
Lymphopenia for paediatric BMT studies (using age, race, and sex normal values)		≥ 75–<100% LLN	≥ 50–<75% LLN	≥ 25–<50% LLN	<25% LLN

Neutrophils/granulocytes (ANC/AGC) for BMT studies	WNIL	$\geq 1.0$ – $<1.5 \times 10^9/L$ $\geq 1000$ – $<1500/mm^3$	$\geq 0.5$ – $<1.0 \times 10^9/L$ $\geq 500$ – $<1000/mm^3$	$\geq 0.1$ – $<0.5 \times 10^9/L$ $\geq 100$ – $<500/mm^3$	$<0.1 \times 10^9/L$ $<100/mm^3$
Platelets for BMT studies	WNIL	$\geq 50.0$ – $<75.0 \times 10^9/L$ $\geq 50\ 000$ – $<75\ 000/mm^3$	$\geq 20.0$ – $<50.0 \times 10^9/L$ $\geq 20\ 000$ – $<50\ 000/mm^3$	$\geq 10.0$ – $<20.0 \times 10^9/L$ $\geq 10\ 000$ – $<20\ 000/mm^3$	$<10.0 \times 10^9/L$ $<10\ 000/mm^3$
Rash/dermatitis associated with high-dose chemotherapy or BMT studies	None	Faint erythema or dry desquamation	Moderate to brisk erythema or a patchy moist desquamation, mostly confined to skinfolds and creases; moderate oedema	Confluent moist desquamation, $\geq 1.5$ cm in diameter, not confined to skinfolds; pitting oedema	Skin necrosis or ulceration of full-thickness dermis; may include spontaneous bleeding not induced by minor trauma or abrasion
Rash/desquamation associated with GVHD for BMT studies	None	Macular or papular eruption or erythema covering $<25\%$ of body surface area, without associated symptoms	Macular or papular eruption or erythema, with pruritus or other associated symptoms, covering $\geq 25$ – $<50\%$ of body surface area or localized desquamation or other lesions covering $\geq 25$ – $<50\%$ of body surface area	Symptomatic generalized erythroderma or symptomatic macular, papular, or vesicular eruption, with bullous formation, or desquamation covering $\geq 50\%$ of body surface area	Generalized exfoliative dermatitis or ulcerative dermatitis or bullous formation
Stomatitis/pharyngitis (oral/pharyngeal mucositis) for BMT studies	None	Painless ulcers, erythema, or mild soreness in the absence of lesions	Painful erythema, oedema, or ulcers, but can swallow	Painful erythema, oedema, or ulcers, preventing swallowing or requiring hydration or parenteral (or enteral) nutritional support	Severe ulceration, requiring prophylactic intubation or resulting in documented aspiration pneumonia

(continued)

Adverse event	Grade				
	0	1	2	3	4
Transfusion: platelets for BMT studies	None	One platelet transfusion in 24h	Two platelet transfusions in 24h	≥3 platelet transfusions in 24h	Platelet transfusions and other measures required to improve platelet increment; platelet transfusion refractoriness associated with life-threatening bleeding (e.g. HLA or cross-matched platelet transfusions)
Transfusion: pRBCs for BMT studies	None	≤2 units of pRBCs in 24h, elective or planned	3 units of pRBCs in 24h, elective or planned	≥4 units of pRBCs in 24h	Haemorrhage or haemolysis associated with life-threatening anaemia; medical intervention required to improve Hb
Transfusion: pRBCs for paediatric BMT studies	None	≤15mL/kg in 24h, elective or planned	>15–≤30mL/kg in 24h, elective or planned	>30mL/kg in 24h	Haemorrhage or haemolysis associated with life-threatening anaemia; medical intervention required to improve Hb
Thrombotic microangiopathy (e.g. TTP or HUS) for BMT studies	–	Evidence of RBC destruction (schistocytosis) without clinical consequences	Evidence of RBC destruction, with elevated creatinine (≤3 × ULN)	Evidence of RBC destruction, with creatinine (>3 × ULN) not requiring dialysis	Evidence of RBC destruction, with renal failure, requiring dialysis, and/or encephalopathy
Weight gain associated with VOD for BMT studies	<2%	≥2–<5%	≥5–<10%	≥10% or as ascites	≥10% or fluid retention, resulting in pulmonary failure

## Bone marrow transplantation: complex/multicomponent events

Adverse event	Grade				
	0	1	2	3	4
<p>Note: the grading of complex/multicomponent events in bone marrow transplant will be defined in the protocol. The grading scale must use the CTC criteria for grading the specific component events (adverse events)</p>					
Failure to engraft	Absent	Mild	Moderate	Severe	Life-threatening
<p>Also consider haemoglobin, neutrophils/granulocytes (ANC/AGC), neutrophils/granulocytes (ANC/AGC) for BMT studies, if specified in the protocol, platelets, platelets for BMT studies, if specified in the protocol</p>					
GVHD	Absent	Mild	Moderate	Severe	Life-threatening
<p>Also consider Fatigue, Rash/desquamation associated with GVHD for BMT studies, if specified in the protocol, Diarrhoea for patients without colostomy, Diarrhoea for patients with colostomy, Diarrhoea associated with GVHD for BMT studies, if specified in the protocol, Diarrhoea for paediatric BMT studies, if specified in the protocol, Bilirubin, Bilirubin associated with GVHD for BMT studies, if specified in the protocol</p>					

(continued)

Adverse event	Grade				
	0	1	2	3	4
Stem cell infusion complications	Absent	Mild	Moderate	Severe	Life-threatening
Also consider Allergic reaction/hypersensitivity, Conduction abnormality/AV heart block, Nodal/junctional arrhythmia/dysrhythmia, Prolonged QTc interval (QTc >0.48s), Sinus bradycardia, Sinus tachycardia, Supraventricular arrhythmias (SVT/AF/atrial flutter), Vasovagal episode, Ventricular arrhythmia (premature ventricular contractions (PVCs)/bigemini/trigemini/ventricular tachycardia), Cardiovascular/Arrhythmia—Other (specify, _____), Hypertension, Hypotension, Fever (in the absence of neutropenia where neutropenia is defined as AGC <1.0 × 10 <sup>7</sup> /L), Rigors/chills, Sweating (diaphoresis), Rash/desquamation, Rash/desquamation associated with GVHD for BMT studies, if specified in the protocol, Urticaria (hives, welts, wheals), Diarrhoea for patients without colostomy, Diarrhoea for patients with colostomy, Diarrhoea associated with GVHD for BMT studies, if specified in the protocol, Diarrhoea for paediatric BMT studies, if specified in the protocol, Nausea, Vomiting, Haemorrhage/bleeding with grade 3 or 4 thrombocytopenia, Haemorrhage/bleeding without grade 3 or 4 thrombocytopenia, Haemoptysis, Alkaline phosphatase, Bilirubin, Bilirubin associated with GVHD for BMT studies, if specified in the protocol, GGT, serum glutamic oxaloacetic transaminase (SGOT) (aspartate aminotransferase, AST), serum glutamic pyruvic transaminase (SGPT) (alanine aminotransferase, ALT), Infection (documented clinically or microbiologically) with grade 3 or 4 neutropenia (ANC <1.0 × 10 <sup>9</sup> /L), Infection without neutropenia, Hyperkalaemia, Hyponatraemia, Hypokalaemia, Depressed level of consciousness, Seizures, Abdominal pain, Headache, Creatinine, Haemoglobinuria	Absent	Mild	Moderate	Severe	Life-threatening
VOD	Absent	Mild	Moderate	Severe	Life-threatening
Also consider Weight gain associated with VOD for BMT studies, if specified in the protocol, Bilirubin, Bilirubin associated with GVHD for BMT studies, if specified in the protocol, Depressed level of consciousness, Hepatic pain, Renal failure, Hepatic enlargement					



# Nomogram for the determination of body surface area

Nomogram for determination of body surface from height and mass

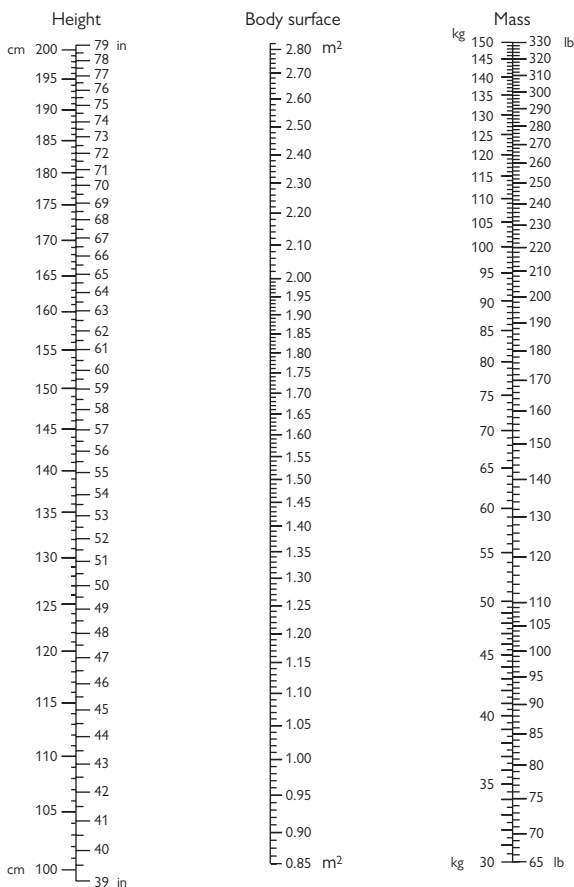

**Fig. A2.1** Nomogram for the determination of the body surface area.

Reproduced with permission from Lentner C, ed. *Geigy Scientific Tables*, 8th edn. Basel: Ciba Geigy Ltd, 1981. BNF body surface area calculator can be accessed on <http://www.bnf.org/bnf/extra/current/450018.htm>.

## Performance status



Many decisions in the management of patients with malignancy depend on the patients' general well-being. Various scoring systems exist which attempt to quantify this. The two most commonly used are the Karnofsky and the ECOG systems (see Table A3.1).

### Karnofsky score

The Karnofsky scoring system is detailed in  Performance status criteria, p. 842.

#### Further reading

Doyle D, Hanks G, Cherny NI, Calman K (eds.) (2005). *Oxford textbook of palliative medicine*, 3rd edn. Oxford: Oxford University Press.

Karnofsky performance status scale definitions rating (%) criteria. Available at:  <http://hospicepatients.org/karnofsky.html>.

Karnofsky DA, Burchenal JH (1949). The clinical evaluation of chemotherapeutic agents in cancer. In: MacLeod CM, ed. *Evaluation of chemotherapeutic agents*. New York: Columbia University Press, p. 196.

Table A3.1 ECOG score

0	Fully active. Able to carry on all pre-disease performance without restriction
1	Restricted in physically strenuous activity, but ambulatory and able to carry out work of a light or sedentary nature
2	Ambulatory and capable of all self-care, but unable to carry out any work activities. Up and about for >50% of waking hours
3	Capable of only limited self-care. Confined to bed or chair for >50% of waking hours
4	Completely disabled. Cannot carry out any self-care. Totally confined to bed or chair
5	Death

### ECOG score

#### Further reading

Onken MM, Creech RH, Tormey DC, et al. (1982). Toxicity and response criteria of the Eastern Cooperative Oncology Group. *Am J Clin Oncol* 5, 649–55.

We credit the Eastern Cooperative Oncology Group, Robert Comis MD, Group Chair.

## Support agencies' addresses and websites

☞ <http://www.adjuvantonline.com>—**Adjuvant! Online**: an American web-site aiming to provide a decision-making tool for doctors to assist in weighing up the relative risks and benefits of adjuvant treatment, depending on certain patient and tumour variables. Currently, it has protocols for breast, colon, and lung cancers.

☞ <http://www.asco.org>—**American Society of Clinical Oncology**.

☞ <http://www.macmillan.org.uk/Home.aspx>—**Cancerbackup**: up-to-date cancer information (including information about treatments), practical advice, and support for cancer patients, their families, and carers. Cancerbackup has now merged with Macmillan Cancer Support and is an approved NHS information partner. Also provides links to useful site-specific websites.

☞ <http://www.cancerresearchuk.org>—**Cancer Research UK**.

☞ <http://www.cancerresearchuk.org/about-cancer>—patient information website: part of **Cancer Research UK**.

☞ <http://www.eortc.be>—the **European Organisation for the Research and Treatment of Cancer (EORTC)**.

☞ <http://www.maggiescentres.org.uk>—**Maggie's Cancer Caring Centres**: patient help with information, benefits, and travel advice for those affected by cancer, and psychological support. Centres are in limited locations at present, but more are planned, and online support groups are available.

☞ <http://www.mariecurie.org.uk>—**Marie Curie Cancer Care**: charitable organization providing free nursing care to cancer patients and those with terminal illnesses in their own homes.

☞ <http://www.cancer.gov>—**National Cancer Institute**: comprehensive cancer information.

☞ [http://ctep.cancer.gov/protocolDevelopment/electronic\\_applications/ctc.htm](http://ctep.cancer.gov/protocolDevelopment/electronic_applications/ctc.htm)—**National Cancer Institute (NCI) CTC toxicity scale version 4.0** (updated May 2009).

☞ <http://www.crn.nihr.ac.uk/cancer>—the **Clinical Research Network (CRN)** aims to provide the NHS with an infrastructure to support high-quality cancer clinical studies.

☞ <http://www.npcp.org.uk>—**National Council for Palliative Care**.

☞ <http://www.nice.org.uk>—**National Institute for Health and Care Excellence**: national guidance on services, interventions, and management.

☞ <http://www.rcr.ac.uk>—**Royal College of Radiologists** home page.

☞ <http://www.teenagecancertrust.org>—**Teenage Cancer Trust UK**.

☞ <http://www.ons.gov.uk/ons/taxonomy/index.html?nscl=Cancer>—**Office for National Statistics, Cancer**.

☞ <http://www.winstonswish.org.uk>—**Winston's Wish**: leading childhood bereavement charity offering practical support and guidance to families, professionals, and anyone concerned about a grieving child.

# Index

## A

- abdominal pain/cramping,  
CTC grading 829
- abiraterone 173
- absolute granulocyte count  
BMT specific adverse  
events 849  
CTC grading 790
- absolute neutrophil count  
BMT specific adverse  
events 849  
CTC grading 790
- acanthosis nigricans 653
- accelerated  
chemotherapy 106
- accelerated radiotherapy 57
- aciclovir 90
- acidosis, CTC grading 818
- Ackerman's tumour 474
- acoustic  
neuroma 507–8, 514
- actinomycin D 86–7
- actionable mutation 23
- active  
immunotherapy 179–93
- acute leukaemia 550–6
- acute lymphoblastic  
leukaemia 550, 551–6
- acute myeloid  
leukaemia 550, 553–6
- acute oncology 692
- acute promyelocytic  
leukaemia 555–6
- acute renal  
failure 738–9, 740
- acute vascular leak  
syndrome, CTC  
grading 794
- adeno-associated virus  
vectors 771
- adenocarcinoma  
anal canal 316  
endometrial 450–2  
pancreatic 358–63  
renal 404  
small intestine 330–5
- adenosine analogues 91–2
- adenoviral vectors 771
- adjuvant analgesics 123–5
- adoptive  
immunotherapy 194
- adrenal cancer 396–9
- adrenalectomy 172
- adrenal failure 160
- adrenogenital syndrome 397
- adult advance life support  
algorithm Inside front  
cover
- adult respiratory distress  
syndrome (ARDS),  
CTC grading 832
- adverse event module 840
- aetiology of cancer 3–15
- aflatoxins 9
- after-loading 71
- AIDS-related  
malignancies 655–69
- air pollution 15
- airway obstruction 703–9
- alanine aminotransferase,  
CTC grading 816
- alcohol intake 8–9, 470
- alemtuzumab 570–1
- alfentanil 121–2, 122
- alkaline phosphatase,  
CTC grading 815
- alkalosis, CTC grading 819
- alkylating agents 85
- allergic reaction, CTC  
grading 786
- allergic rhinitis, CTC  
grading 786
- allergy, CTC grading 786
- alopecia, CTC grading 800
- alveolar  
rhabdomyosarcoma 626
- amino-glutethimide 173
- amitriptyline 123–4
- ampullary carcinoma 368–9
- amylase, CTC grading 819
- amyloidosis 594, 595–6
- anaemia, haemolytic 652
- anal cancer 311  
adenocarcinoma 316  
chemo-irradiation 109  
HIV-related 668  
malignant melanoma 316  
squamous cell  
carcinoma 314–15
- anal fistula, CTC  
grading 809
- analgesics 117–25
- anal intra-epithelial  
neoplasia 668
- anaplastic astrocytoma 514
- anastrozole 173
- angiogenesis 776
- angular cheilitis 150
- Ann Arbor staging 575, 576
- anorexia 140–1  
CTC grading 805
- anthracyclines 86–7, 164
- antibiotics,  
anti-tumour 86–7
- anticipatory nausea and  
vomiting 131
- anticonvulsants 123–4
- antidepressants 123–4
- anti-emetics 129–30, 131
- anti-folates 88
- anti-lymphocyte  
globulin 565
- anti-metabolites 88–92
- anti-microtubule  
agents 100, 101
- anti-purines 90
- antiretroviral therapy 657
- anti-sense DNA  
oligonucleotides 762
- anti-tumour antibiotics  
86–7
- anxiety, CTC grading 825
- anxiolytics 154–5
- APC 5, 20–1
- aphasia, CTC grading 826
- aphthous ulcers 151
- apnoea, CTC grading 832
- apoptosis 105
- appetite stimulants 141
- aprepitant 130
- ara-C (syndrome) 91
- arachis oil 137
- arachnoiditis, CTC  
grading 822
- area postrema 126, 128
- aromatase inhibitors 173
- arrhythmias, CTC  
grading 793
- arterial operative injury,  
CTC grading 797
- arterial thromboembolic  
disease 714
- arthralgia, CTC grading 829
- arthritis, CTC grading 821
- asbestos 15
- ascites  
CTC grading 806  
palliative surgery 39
- Askin tumour 612
- aspartate aminotransferase,  
CTC grading 816
- asthenia, CTC grading 799
- ataxia, CTC grading 822
- ataxia-telangiectasia 5, 14
- ATM 5
- atrial fibrillation/flutter,  
CTC grading 793

- atrioventricular heart block,  
CTC grading 792
- attenuated FAP 28–9
- auditory symptoms,  
CTC grading 787
- autoimmune haemolytic  
anaemia 652
- autoimmune  
neutropenia 652
- autoimmune reaction,  
CTC grading 786
- avascular necrosis,  
CTC grading 822
- Avastin® (bevacizumab) 189
- axillary lymph node  
metastases 636
- axillary surgery 283–4
- axon guidance pathway 22
- azacytidine 564–5
- azathioprine 90
- B**
- bacillus Calmette–Guérin  
(BCG) 190
- bacterial infections  
cancer link 13  
mouth 151
- bad news 113
- Barrett's  
oesophagus 214–15
- basal cell carcinoma 542,  
543, 544
- B-cell chronic lymphocytic  
leukaemia 566–7
- BCG 190
- bcl-2* 762
- BCNU 85
- Beckwith–Wiedemann  
syndrome 412
- behavioural changes, CTC  
grading 826
- benzene exposure 15
- benzodiazepines 124, 143
- $\beta$  emitters 72
- bevacizumab 189
- bicalutamide 174
- bicarbonate, CTC  
grading 819
- bilharzial bladder disease 13
- biliary obstruction 726–9
- biliary tract cancer 376–80
- bilirubin  
BMT specific adverse  
events 848  
CTC grading 815
- biochemical crises 731–42
- biological therapy 179–95
- biological vectors 770, 771
- biomarkers 773–80
- biopsies 34–5
- bisacodyl 137
- Bismuth–Corlette  
classification 378
- bisphosphonates  
adjuvant analgesia 124  
bone metastases 294–5  
hypercalcaemia 733
- bladder  
operative injury, CTC  
grading 835  
RTOG/EORTC late  
radiation morbidity  
scoring 844  
spasms, CTC grading  
834
- bladder cancer 418–23  
aetiology 418  
BCG therapy 190  
chemo-irradiation 109  
chemotherapy 422, 423  
epidemiology 418  
genetics 418  
investigations 419  
muscle-invasive 420  
occupational risks 418  
parasitic infection 13  
pathology 418  
presentation 419  
prognosis 422  
radical radiotherapy 421  
radical surgery 420, 421  
staging 419  
superficial tumour  
management 420
- bleeding, CTC  
grading 813–15
- bleomycin 164–5
- blood, CTC grading 788
- Bloom's syndrome 14
- Blumgart classification 379
- blurred vision, CTC  
grading 828
- body surface area  
nomogram 854
- bone  
effects of chemotherapy  
and radiotherapy 166  
malignancies 604  
metastases 43–4, 77–8,  
294–5, 617, 639  
pain, CTC grading 830  
RTOG/EORTC late  
radiation morbidity  
scoring 844  
sarcoma reference  
centres 604  
scintigraphy 76–7  
bone marrow, CTC  
grading 788
- bone marrow  
suppression 686
- bone marrow  
transplantation  
complex/multicomponent  
events 851  
specific adverse  
events 848
- botryoid  
rhabdomyosarcoma 626
- bowel cancer 28–9; see also  
colorectal cancer  
bowel obstruction 38,  
128–9, 130, 132
- brachial plexus block 124
- brachytherapy 70–3, 432
- BRAF 20, 23, 24
- brain irradiation 168  
prophylactic 249  
RTOG/EORTC late  
radiation morbidity  
scoring 844  
side-effects 512
- brain metastases 44,  
518–20, 639
- BRCA 1/2 5, 21, 27, 46,  
214–15, 266–7
- breaking bad news 113
- breast cancer 261–97  
adjuvant systemic  
therapy 286–9  
aetiology 264–5  
alcohol intake 8–9  
axillary surgery 283–4  
biomarkers 774, 778
- bisphosphonates 294–5
- BRCA 1/2 5, 21, 27,  
214–15, 266–7
- chemopreven-  
tion 210–11, 267
- combination chemother-  
apy 286–7, 292–4
- combination hormone  
therapy 174
- diagnosis 278
- ductal carcinoma  
*in situ* 270, 280–1
- ductal carcinoma of special  
type 271
- early invasive cancer  
management 282–4
- endocrine  
therapy 288, 292
- epidemiology 264–5
- family history 27, 267
- gene expression  
profiling 272  
genetics 266–8  
HER2-positive 271
- interval cancers 276
- invasive ductal  
carcinoma 270–1
- invasive lobular  
carcinoma 271
- investigations 278
- lapatinib 294



- lobular carcinoma  
*situ* 270, 280–1
- locally advanced  
 disease 290
- loco-regional  
 radiotherapy 285
- males 265, 296
- metastatic 292–5
- micrometastases 284
- neoadjuvant  
 therapy 288, 289
- oestrogen  
 receptor-positive 270
- pathology 270–6
- presentation 278–9, 279
- prognosis 297
- prophylactic  
 surgery 214–15, 266
- reconstructive surgery  
 283
- risk factors 204, 264–5
- screening 219,  
 266–7, 274–6
- staging 279
- tamoxifen 210–11,  
 267, 288
- targeted therapy 294
- trastuzumab 294
- triple assessment 278
- triple negative 271
- breathlessness 142–3  
 CTC grading 833
- Brigham staging 254
- bruising, CTC grading 800
- bulking agents 137
- bullous lesions 653
- Burkitt's leukaemia 552, 590
- Burkitt's  
 lymphoma 13, 589–90
- busulphan 85
- bystander effect 764
- C**
- CA125 446
- cachexia 140–1, 654
- caesium-137 72
- Cairo–Bishop definition 741
- camptothecin 98
- cancer of unknown  
 primary, see malignancy  
 of unknown primary
- cancer phenotype 19
- capecitabine 90
- carbamazepine 123–4
- carbon monoxide diffu-  
 sion capacity, CTC  
 grading 832
- carboplatin 94–6
- carcinoembryonic antigen  
 (CEA) 767
- carcinoid syndrome 332
- carcinosarcomas 452
- cardiac disease 716–17
- cardiac ischaemia/infarction,  
 CTC grading 794
- cardiac troponin I and T,  
 CTC grading 795
- cardiovascular system  
 CTC grading 792–7  
 effects of chemotherapy  
 and radiotherapy 164
- carmustine 85
- carotenoids 209
- castration 172
- cataract, CTC grading 827
- catheter-related infection,  
 CTC grading 817
- cauda equina syndrome 682
- CB1954 764
- CD4 count, CTC  
 grading 788
- CEA 767
- cell signalling 775, 777
- central nervous system  
 haemorrhage/bleeding,  
 CTC grading 814  
 radiation effects 54, 512
- central nervous system  
 tumours 495–520  
 aetiology 496, 497  
 AIDS-related 664–5  
 biomarkers 779  
 chemotherapy 513  
 craniospinal  
 irradiation 510–11  
 epidemiology 496  
 gene therapy 516  
 hereditary syndromes 497  
 investigations 502  
 multidisciplinary  
 management 504  
 palliative radiotherapy 510  
 pathology 496–500  
 presentation 500, 501  
 prognosis 514–15  
 radical radiotherapy 510  
 radiotherapy 510–12, 516  
 staging 502  
 stereotactic  
 radiotherapy 512  
 surgical  
 neuronavigation 516  
 treatment 504–13  
 WHO  
 classification 497, 498
- central venous lines 744–5
- cerebrovascular ischaemia,  
 CTC grading 822
- cervical cancer 454–7  
 HIV-positive females 666  
 screening 220
- cervical lymph node  
 metastases 636
- cervical smear 220
- cetuximab 189
- Chang system  
 (modified) 508, 509
- CHART regimen 57, 242
- chemical carcinogens 15
- chemo-endocrine  
 therapy 177
- chemo-irradiation 108–9,  
 755
- chemoprevention 204,  
 210–11, 212, 213, 267
- chemotherapy 83–109  
 accelerated 106  
 agents 85–100  
 anti-emetic choice 131  
 combined with hormone  
 therapy 177  
 combined with radiother-  
 apy (chemo-irradiation)  
 108–9, 755  
 dose intensification 106  
 drug resistance 104–5  
 extravasation 746  
 high-dose 106  
 late effects 157–68  
 neuropsychological  
 consequences 168  
 rationale for combination  
 therapy 84  
 secondary  
 malignancies 167  
 targeted 84
- chest pain, CTC grading 830
- childhood cancers presenting  
 in adults 671–6
- Child–Pugh scoring  
 system 341
- chills, CTC grading 799
- chlorambucil 85
- 2-chlorodeoxyadenosine 92
- cholangiocarcinoma 376–80
- chondrosarcoma 616
- chordoma 616–17
- choriocarcinoma 462–4
- chronic lymphoid  
 leukaemias 566–72
- chronic myeloid leukaemia  
 183, 191, 558–60
- circulating tumour cells  
 775
- cisplatin 95–6
- cladribine 92
- classical multidrug  
 resistance 104
- clinical trials 199–202,  
 210–11, 752
- CNS, see *central nervous  
 system headings*
- coagulation, CTC  
 grading 797–8
- coagulopathy 652

- cobalt teletherapy 60  
 co-danthramer 137  
 co-danthrusate 137  
 codeine 118  
 coeliac plexus block 124  
 cognitive dysfunction 168  
   CTC grading 823  
 colitis, CTC grading 806  
 colorectal cancer 299–310  
   adjuvant  
     chemotherapy 304–5  
   biomarkers 779  
   chemotherapy  
     for advanced  
       disease 306–9  
   hereditary non-polyposis  
     28–9, 214–15  
   liver metastases 350–6  
   multistep  
     carcinogenesis 24  
   pauci-metastatic  
     disease 306–9  
   prophylactic  
     surgery 214–15  
   radiotherapy 310  
   recurrent 303  
   screening 220  
   single-nucleotide  
     polymorphisms 30  
   surgery 302–3  
 Common Toxicity Criteria  
   (CTC) 786–38  
 communication 112–13  
 conduction abnormality,  
   CTC grading 792  
 confirmed carcinoma of  
   unknown primary 630  
 conformal  
   radiotherapy 64, 754  
 confusion, CTC grading 823  
 conjunctivitis, CTC  
   grading 827  
 Conn's syndrome 397  
 consciousness, CTC  
   grading 823  
 constipation 120, 136–7  
   CTC grading 806  
 constitutional  
   symptoms 654  
   CTC grading 799–800  
 cord compression 682  
 core biopsy 34–5  
 corneal inflammation/ulcera-  
   tion, CTC grading 828  
 corticosteroids, appetite  
   stimulation 141  
 cough 143–4  
   CTC grading 833  
 Courvoisier's law 727  
 Cowden syndrome 20–1,  
   25, 214–15, 497  
 cranial irradiation 168  
   prophylactic 249  
   RTOG/EORTC late  
     radiation morbidity  
       scoring 844  
     side-effects 512  
 cranial neuropathy, CTC  
   grading 825  
 craniopharyngioma 507, 514  
 craniospinal  
   irradiation 510–11  
 creatine phosphokinase,  
   CTC grading 819  
 creatinine, CTC grading 835  
 cupitch syndrome 146  
 curative surgery 36–7  
 Cushingoid appearance,  
   CTC grading 805  
 Cushing's  
   syndrome 397, 648  
 cyclizine 129–30  
 cyclophosphamide 85  
 CYP17A1 173  
 cytarabine 91  
 cytokines 190–3  
 cytoreductive surgery 40  
 cytosine analogues 91  
 cytosine arabinoside 91
- D**  
 dactinomycin 87  
 dantron 137  
 dasatinib 559, 560  
 daunorubicin 86–7  
 deactivating enzyme 776  
 dehydration, CTC  
   grading 806  
 delusions, CTC grading 823  
 dendritic cell  
   vaccination 767–8  
 dentures 150  
 2'-deoxycytosine 91–2  
 depressed consciousness,  
   CTC grading 823  
 depression, CTC  
   grading 825  
 dermatitis  
   BMT specific adverse  
     events 849  
   CTC grading 802, 803  
   exfoliative 653  
 dermatitis herpetiformis 653  
 dermatological  
   paraneoplastic  
     syndromes 653  
 dermatology, CTC  
   grading 800–4  
 dermatomyositis 651  
 desquamation  
   BMT specific adverse  
     events 849  
   CTC grading 803, 804  
 dexametha-  
   sone 123–4, 129–30  
 diamorphine 121–2  
 diaphoresis, CTC  
   grading 799  
 diarrhoea 138  
   BMT specific adverse  
     events 848  
   CTC grading 806–7  
   overflow 136  
 diclofenac 118  
 diet 9, 208–9, 470  
 diethylstilbestrol 15  
 diffuse large B-cell  
   non-Hodgkin's  
   lymphoma 591–2  
 2,2-difluoro-deoxycytidine  
   91  
 dihydrocodeine 118  
 dihydropyridine  
   dehydrogenase 776  
 diplopia, CTC grading 828  
 discharge from  
   follow-up 114  
 disseminated intravascular  
   coagulation 715  
 dizziness, CTC grading 823  
 DNA repair enzymes 776  
 DNA repair genes 4–5  
 DNA vaccines 767  
 docetaxel 102  
 docosate 137  
 domperidone 129–30  
 dorsal motor nucleus of the  
   vagus 126  
 double vision, CTC  
   grading 828  
 doxorubicin 86–7, 164  
 drip and suck 130  
 driver mutations 22  
 drug discovery 750–2  
 drug fever, CTC grading  
   786  
 drug-related haemolysis 789  
 drug resistance 104–5  
 dry eye, CTC grading 828  
 dry mouth 151–2  
   CTC grading 810  
 dry skin, CTC grading 801  
 ductal carcinoma *in*  
   *situ* 270, 280–1  
 ductal carcinoma of special  
   type 271  
 duodenal ulcer, CTC  
   grading 807  
 dye workers 15  
 dysgeusia, CTC grading 812  
 dysmenorrhoea, CTC  
   grading 830  
 dyspareunia, CTC  
   grading 830  
 dyspepsia, CTC grading 807

dysphagia, CTC grading 808  
 dysphasia, CTC grading 826  
 dyspnoea, CTC grading 833  
 dysuria, CTC grading 835

## E

ear, effects of chemotherapy and radiotherapy 165  
 earache, CTC grading 830  
 ECOG score 842, 856  
 EGFR pathway  
 inhibitors 184–5  
 eicosapentanoic acid 141  
 electron beam  
 therapy 60, 68–9  
 embolism, CTC grading 797  
 embryonal  
 tumours 626, 674–5  
 embryo storage 163  
 encephalomyelopathies 650  
 endocarditis 716  
 endocrine cancers 381–401  
 endocrine  
 dysfunction 160–1  
 CTC grading 805  
 endocrine gland  
 ablation 172  
 endocrine paraneoplastic  
 syndromes 648–9  
 endocrine syndromes 397  
 endocrine therapy, see  
 hormone therapy  
 end of life 154–5  
 endometrial  
 adenocarcinoma 450–2  
 endoscopic retrograde  
 cholangiopancreatogra-  
 phy 46, 727–8  
 endoscopic techniques 34–5  
 enteral feeding 141  
 environmental expo-  
 sures 15, 205, 471  
 EORTC QLQ-C30 202  
 eosinophilia 652  
 EPA 141  
 ependymoma 505–6,  
 508, 514  
 epidemiology 3–15  
 epidural analgesia 124  
 epirubicin 86–7, 164  
 epistaxis, CTC grading 814  
 Epstein-Barr virus 13,  
 195, 470  
 ERBB2/3 20  
 Erbitux® 189  
 erectile impotence, CTC  
 grading 837  
 erlotinib 182, 184  
 erythema multiforme, CTC  
 grading 801  
 erythematous lesions 653

erythrocytosis 652  
 erythroplakia 474  
 erythropoietin 192, 563  
 estramustine phosphate 103  
 etoposide 99  
 euphoria, CTC grading 825  
 Ewing's sarcoma 612–15  
 excisional biopsy 34–5  
 exemestane 173  
 exercise 10  
 exfoliative dermatitis 653  
 exposure 14–15  
 external auditory canal, CTC  
 grading 787  
 external beam  
 radiotherapy 60–7, 754  
 extra-nodal marginal zone  
 lymphoma 588  
 extrapyramidal symptoms,  
 CTC grading 824  
 extravasation 746  
 eye  
 cancer-associated  
 retinopathy 651  
 CTC grading 827–9  
 intraocular  
 tumours 492, 540  
 long-term effects of  
 chemotherapy and  
 radiotherapy 165  
 metastatic disease 492  
 retinoblastoma 5,  
 492, 674  
 retinopathy of hypervis-  
 cosity syndrome 595  
 RTOG/EORTC late  
 radiation morbidity  
 scoring 844

## F

faecal occult blood test  
 220  
 fainting, CTC grading 827  
 familial adenomatous  
 polyposis 5, 20–1,  
 28–9, 214–15  
 familial cancers 25  
 Fanconi's syndrome,  
 CTC grading 836  
 fat consumption 9, 208  
 fatigue, CTC grading 799  
 febrile neutropenia,  
 CTC grading 817  
 feminization of male,  
 CTC grading 805  
 feminization syndrome 397  
 fentanyl 121–2  
 fertility 162–3  
 fever 654, 687  
 CTC grading 799  
 fibre, dietary 9, 208

fibrinogen, CTC grading 797  
 field effect 475  
 FIGO staging 455  
 fine needle aspiration 34–5  
 fistulas 38–9  
 CTC grading 808–9, 835  
 flashing lights, CTC  
 grading 829  
 flatulence, CTC grading  
 809  
 floaters, CTC grading 829  
 floxuridine 90  
 fludarabine 91  
 2-fluoro-2'-deoxyuridine 90  
 fluoropyrimidines 88  
 5-fluorouracil 89  
 5-fluorouracil  
 pro-drugs 89–90  
 flushing, CTC grading 801  
 flutamide 174  
 FOB test 220  
 folate 88, 208  
 folinic acid 90  
 follicular lymphoma 585–7  
 Fong score 42–3, 355  
 forced expiratory volume in  
 1s, CTC grading 833  
 formaldehyde 471  
 four-dimensional  
 radiotherapy 67  
 fractionated radiother-  
 apy 50, 56–8, 755  
 fractionated stereotactic  
 radiotherapy 512  
 frozen embryos 163  
 fruit consumption 9, 208  
 fulvestrant 173  
 fungal mouth infections 151

## G

G3139 762  
 gabapentin 123–4  
 gall bladder cancer 372–5  
 $\gamma$  emitters 72  
 $\gamma$ -knife 754  
 ganciclovir 90  
 gastric cancer 13,  
 214–15, 324–8  
 gastric irritation 131  
 gastric stasis 132  
 gastric ulcer, CTC  
 grading 809  
 gastrinoma 365  
 gastritis, CTC grading 809  
 gastrointestinal bleeding  
 CTC grading 815  
 palliative surgery 40  
 gastrointestinal obstruc-  
 tion 128–9, 132, 720–3  
 gastrointestinal stromal  
 tumours 183–4, 623–4

- gastrointestinal symptoms, CTC grading 805–13
- gastrointestinal tract, radiation effects 54
- gefitinib 184
- Gelclair® 151
- gemcitabine 91
- Genasense® 762
- gender and cancer risk 6
- Genicine® 762
- gene delivery 770, 771
- gene-directed enzyme pro-drug system 764, 765
- gene expression profiling 272
- gene therapy 516, 759–71
- genetic predisposition 25
- genetic pro-drug activation therapy 764, 765
- genetics of cancer 4–5, 17–30, 205; *see also specific cancers*
- genetic testing 26
- genitourinary cancers 403–43
- genitourinary symptoms, CTC grading 834–7
- germ-cell tumours 506, 514
- germinoma 506, 514
- gestational trophoblastic disease 460–4
- glaucoma, CTC grading 828
- Gleason score 424
- glioblastoma 514
- glioma 500, 501, 504–5, 508, 514
- Glivec® 183–4
- glucagonoma 365
- glutathione 105
- glycerine suppositories 137
- glycopyrronium 155
- gonadal dysfunction 162
- gonadotrophin-releasing hormone analogues 172
- Gorlin syndrome 25, 497
- graft versus host disease 851
- granisetron 129–30
- granulocyte colony-stimulating factor 192–3, 563
- granulocytes BMT specific adverse events 849 CTC grading 790
- granulocytosis 652
- Grawitz tumours 404
- gray units 50
- great vessel tumours 717
- gynaecological cancer 445–64
- gynaecomastia, CTC grading 805
- H**
- haematemesis, CTC grading 814
- haematochezia, CTC grading 815
- haematological malignancies 549–600
- haematological paraneoplastic syndromes 652
- haematuria, CTC grading 814
- haemoglobin, CTC grading 789
- haemoglobinuria, CTC grading 835
- haemolysis, CTC grading 789
- haemolytic anaemia 652
- haemolytic uraemic syndrome, CTC grading 798
- haemoptysis, CTC grading 814
- haemorrhage, CTC grading 813–15
- hairy cell leukaemia 191
- hallucinations, CTC grading 824
- haloperidol 129–30, 155
- hand-foot skin reaction, CTC grading 801
- headache, CTC grading 830
- head and neck cancer 467–92 aetiology 470–1 alcohol intake 8–9, 470 anatomical sites 468, 469 chemo-irradiation 109, 485–6 early-stage disease 483–6 epidemiology 472 follow-up 488–9 genetics 471 investigations 478–9 locally advanced unresectable disease 485–6 management 482–7 metastatic disease 487 pathology 474–5 precancerous lesions 471, 482 presentation 476–7 prevention 473 prognosis 488–9 rehabilitation 490–1 TNM staging 480
- health-related quality of life 202
- hearing loss CTC grading 787 following chemotherapy and radiotherapy 165
- heart chemotherapy effects 164 marantic endocarditis 716 radiation effects 54, 164 RTOG/EORTC late radiation morbidity scoring 845 tumours 717
- heartburn, CTC grading 807
- Helicobacter pylori* 13, 324
- heparin 712, 713
- heparin-induced thrombocytopenia 713
- hepatic enlargement BMT specific adverse events 848 CTC grading 816
- hepatic pain, CTC grading 831
- hepatic symptoms, CTC grading 815–16
- hepatitis B virus 12, 195, 336–7
- hepatitis C virus 12, 336–7
- hepatocellular carcinoma 336 adjuvant therapy 348 aetiology 9, 12, 336–8 BCLC management schema 345 epidemiology 336 investigation 339–41 liver transplantation 344–7 locally advanced disease 348 metastatic disease 348 neoadjuvant therapy 348 pathology 337–9 presentation 338–41 radiofrequency ablation 347–8 staging 341 surgical resection 344
- hepatorenal syndrome 729
- Her2/neu receptor 767
- Her2/neu receptor inhibitors 184–5
- Herceptin® (trastuzumab) 164, 188, 294
- hereditary diffuse gastric cancer 214–15
- hereditary non-polyposis colon cancer 28–9, 214–15
- herpes virus vectors 771

- hiccup 134–5  
CTC grading 833
- high-dose  
chemotherapy 106
- high fibre diet 9, 208
- HIV/AIDS-related  
malignancies 655–69
- hives, CTC grading 804
- HMLH1* 21
- hoarseness, CTC grading 834
- Hodgkin's  
lymphoma 574–80  
aetiology 574  
Ann Arbor  
staging 575, 576  
diagnosis 574  
epidemiology 574  
Epstein-Barr virus 13  
HIV-related 668  
management 577–80  
nodular lymphocyte-  
predominant 574  
pathology 574  
PET scanning 575  
presentation 574  
prognosis 575, 576  
salvage therapy 579–80  
WHO classification 575
- hormone therapy 169–77  
combined with  
chemotherapy 177  
duration 177  
predictors of  
response 175  
resistance to 176  
types of therapy 172–4
- hot flashes/flushes, CTC  
grading 805
- human herpes virus  
(HHV-8) 658
- human papilloma virus  
(HPV) 12, 195, 470
- humoral hypercalcaemia of  
malignancy 649
- hydatidiform moles 460–2
- hydromorphone 122
- hydroxyurea 92
- hyoscine butyl  
bromide 124, 155
- hyoscine hydrobromide  
155
- hyperaldosteronism,  
primary 397
- hypercalcaemia 649, 732–3  
CTC grading 819
- hypercholesterolaemia,  
CTC grading 819
- hyperfractionation 57
- hyperglycaemia 737  
CTC grading 819
- hyperkalaemia 736, 740  
CTC grading 819
- hypermagnesaemia, CTC  
grading 819
- hypernatraemia, CTC  
grading 819
- hypernephroma 404
- hyperphosphataemia 740
- hypersensitivity, CTC  
grading 786
- hypertension, CTC  
grading 795
- hypertriglyceridaemia, CTC  
grading 819
- hypertrophic  
osteoarthropathy 653
- hyperuricaemia 740  
CTC grading 820
- hypoalbuminaemia, CTC  
grading 816
- hypocalcaemia 649, 740  
CTC grading 820
- hypoglycaemia 649, 737  
CTC grading 820
- hypokalaemia, CTC  
grading 820
- hypomagnesaemia 740  
CTC grading 820
- hyponatraemia 734–5  
CTC grading 820
- hypopharyngeal cancer 477
- hypophosphataemia, CTC  
grading 820
- hypophysectomy 172
- hypotension, CTC  
grading 795
- hypothyroidism, CTC  
grading 805
- hypoxanthine guanine  
phosphoribosyl  
transferase 90
- hypoxia  
CTC grading 833  
radiotherapy 55
- hypoxic cell sensitizers 755
- I**
- ibuprofen 118
- ICSI 163
- idarubicin 86–7
- idiopathic  
thrombocytopenia 652
- ifosfamide 85
- ileus, CTC grading 809
- image-guided  
radiotherapy 66
- imaging biomarkers 777
- imatinib 183–4
- imipramine 123–4
- immune haemolytic anaemia,  
CTC grading 789
- immunology, CTC  
grading 786
- immunotherapy 190–4,  
761, 766–8
- impotence, CTC  
grading 837
- incisional biopsy 34–5
- incontinence, CTC  
grading 835
- induced vulnerabilities 23
- industrial exposure 15, 418
- infection  
cancer link 12–13, 470  
central venous lines 744–5  
CTC grading 817–18  
infection module 841  
infertility 162–3  
CTC grading 838  
information giving 112–13
- inguinal lymph node  
metastases 636–7
- injection site reaction, CTC  
grading 801
- inner ear, CTC grading 787
- insomnia, CTC grading 824
- insulinoma 364–5
- integrated care pathway 156
- intensity-modulated  
radiotherapy 66–7, 754
- interferons 191, 408, 534
- interleukin-2 191–2, 408
- interval cancers 276
- intestinal fistula, CTC  
grading 809
- intestinal obstruction 128–9,  
132, 720–3
- intracavitary therapy 78
- intracranial pressure,  
raised 128, 132, 700–2
- intracranial tumours 497,  
499, 500, 501
- intraductal papillary mucin-  
ous neoplasms 215
- intraocular  
tumours 492, 540
- intraoperative  
radiotherapy 74, 754
- intrathecal analgesia 124
- involuntary movements,  
CTC grading 824
- iodine-125 72
- iodine-131 77, 390–1
- ionizing radiation, cancer  
link 14
- Iressa® 184
- iridium-192 72
- irinotecan 98
- irritability, CTC grading 824
- J**
- jaundice,  
obstructive 39, 726–9
- joint pain, CTC grading 829

- joints, RTOG/EORTC late radiation morbidity scoring 845
- junctional arrhythmias/dysrhythmias, CTC grading 793
- K**
- Kaposi's sarcoma 658–61
- Karnofsky score 229, 842
- keratitis, CTC grading 828
- ketamine 124
- kidney, radiation effects 54
- Klatskin tumour 377
- KRAS 24
- L**
- laboratory results, CTC grading 818–21
- lactulose 137
- Lambert–Eaton myasthenic syndrome 651
- L & H Hodgkin cells 574
- Lansky score 842
- laparoscopy 34–5, 36–7
- lapatinib 182, 184–5, 294
- large intestine, RTOG/EORTC late radiation morbidity scoring 846
- laryngeal cancer 472, 476, 488
- laryngectomy 490
- laryngitis, CTC grading 834
- larynx
- CTC grading 834
  - RTOG/EORTC late radiation morbidity scoring 845
- laxatives 137
- lead time bias 218
- learning problems, CTC grading 823
- left ventricular function, CTC grading 794
- leiomyosarcomas 452
- lenalidomide 564–5, 598
- length bias 218
- lentivirus vectors 771
- leptomeningeal disease 639
- lethargy, CTC grading 799
- letrozole 173
- leucocytes
- BMT specific adverse events 848
  - CTC grading 789
- leucoencephalopathy, CTC grading 824
- leukaemia
- acute lymphoblastic 550, 551–6
  - acute myeloid 550, 553–6
  - acute
    - promyelocytic 555–6
  - B-cell chronic
    - lymphocytic 566–7
  - Burkitt's 552, 590
  - chronic lymphoid 566–72
  - chronic myeloid 183, 191, 558–60
    - hairy cell 191
  - leukoplakia 474
  - levomepromazine 129–30, 155
  - Lhermitte's syndrome 54
  - libido, CTC grading 838
  - Li–Fraumeni
    - syndrome 20–1, 497
  - lightheadedness, CTC grading 823
  - linear quadratic model 56
  - lipase, CTC grading 820
  - liver
    - capsular stretch 128, 132
    - CTC grading 816
    - metastases 42–3, 350–6, 638
  - RTOG/EORTC late radiation morbidity scoring 846
  - transplantation 344–7
  - see also hepatocellular carcinoma
- lobular carcinomain *situ* 270, 280–1
- loperamide 138
- lorazepam 129–30
- loss of function 22
- low molecular weight heparin 712, 713
- low-risk alleles 30
- lung
- metastases 43, 259, 638
  - radiation effects 54
  - RTOG/EORTC late radiation morbidity scoring 846
- lung cancer
- aetiology 226
  - biomarkers 778
  - epidemiology 226, 227
  - genetics 228
  - HIV patients 669
  - investigations 229, 230
  - pathology 227
  - performance status 229
  - presentation 228
  - prevention 226
  - screening 220–1, 226
  - smoking link 8
  - see also non-small-cell lung cancer; small-cell lung cancer
- luteinizing hormone-releasing hormone (LHRH) analogues 172
- lymphatic clearance 42
- lymphatics, CTC grading 818
- lymph node
- dissection 532–3
  - metastases 636–7
- lymphoblastic lymphoma 590
- lymphocyte-activated killer (LAK) cells 194
- lymphoedema 148–9
- lymphoma
- bone 617
  - Burkitt's 13, 589–90
  - CNS 507, 514, 664–5
  - follicular 585–7
  - lymphoblastic 590
  - mantle cell 588–92
  - marginal zone 588
  - small bowel 330–5
  - see also Hodgkin's lymphoma; non-Hodgkin's lymphomas
- lymphopenia
- BMT specific adverse events 848
  - CTC grading 790
- lymphorrhoea 149
- Lynch syndrome (HNPCC) 28–9, 214–15
- M**
- MAGE-1 767
- Makuuchi schema 342
- malaise, CTC grading 799
- malaria 13
- malignancy of unknown primary 629–43
- aetiology 631
  - definition 630
  - epidemiology 631
  - management 634–5, 642, 643
  - pathology 632–3
  - prognosis 631
- malignant melanoma 526–39
- adjuvant therapy 534–5
  - aetiology 526–7
  - anal canal 316
  - BCG therapy 190
  - benign pigmented naevi 526–7, 527
  - epidemiology 526–7
  - genetics 526–7
  - interferon therapy 191, 534
  - interleukin therapy 192

- investigation 529–30  
 loco-regionally advanced disease 535  
 metastatic disease 536–9  
 pathology 530–1  
 post-operative surveillance 533  
 presentation 528  
 prevention 528  
 prognosis 533  
 relapse risk 533  
 screening 528  
 staging 531  
 sun exposure 14, 526–7  
 surgery 532–3  
 warning signs 528  
 malignant pleural mesothelioma 252–5  
 mammographic screening 219, 274–6  
 Manchester A point 73  
 mantle cell lymphoma 588–92  
 MAPK inhibitors 186  
 marantic endocarditis 716  
 marginal zone lymphoma 588  
 masculinization of female, CTC grading 805  
*MDR1* 86  
 mediastinal lymph node metastases 637  
 medulloblastoma 508, 509, 514, 674  
 megavoltage radiotherapy 60, 61  
 megestrol acetate 141  
 melaena, CTC grading 815  
 melanoma  
   intraocular 540  
   mucosal 183, 541  
   see also malignant melanoma  
 melphalan 85  
 memory loss, CTC grading 825  
 meningioma 506, 508, 514  
 meningismus, CTC grading 822  
 meningitis, carcinomatous 518  
 menses, CTC grading 838  
 6-mercaptopurine 90  
 Merkel cell carcinoma 547  
 mesothelioma 252–5  
 metabolic acidosis, CTC grading 818  
 metabolic alkalosis, CTC grading 819  
 metabolic dysfunction 160–1  
 CTC grading 818–21  
 metabolic syndrome 161  
 metastatic disease  
   bone 43–4, 77–8, 294–5, 617, 639  
   brain 44, 518–20, 639  
   eye 492  
   heart and great vessels 717  
   liver 42–3, 350–6, 638  
   lung 43, 259, 638  
   lymph nodes 636–7  
   peritoneum 637  
   skin 542  
   surgery for 42–5  
 methadone 122  
 methotrexate 88  
 metoclopramide 129–30  
 MIBG therapy 77  
 micro-angiopathic haemolytic anaemia 652  
 microRNA (miRNA) 774–5  
 microsatellite instability 28–9  
 midazolam 154–5  
 middle ear, CTC grading 787  
 Mini-Mental Score 515  
 mismatch repair genes 21, 28–9  
 mitomycin C 87  
 mitotane 398–9  
 mitoxantrone 87  
 modified Chang system 508, 509  
 Mohs' micrographic surgery 545  
 molar pregnancy 460–2  
 monoclonal antibodies 78, 188–9  
 monoclonal B-lymphocytosis 568–72  
 monoclonal gammopathy of uncertain significance (MGUS) 594, 596–7  
 mood, CTC grading 825  
 morphine 118–22, 122  
 motion sickness 132  
 motor neuropathy, CTC grading 825  
 mouthcare 150–2  
 Movicol® 137  
 MRP 86  
 mTOR inhibitors 185–6  
 mucosal melanoma 183, 541  
 mucositis 151  
   BMT specific adverse events 849  
   CTC grading 810–13  
 mucous membrane, RTOG/EORTC late radiation morbidity scoring 846  
 multidisciplinary approach 32, 112  
 multidrug resistance 104  
 multidrug resistance-associated protein 105  
 multileaf collimators 64  
 multiple endocrine neoplasia (MEN) type II 214–15, 383  
 multiple myeloma, see myeloma  
 multistep carcinogenesis 24  
 muscle pain, CTC grading 831  
 muscle weakness, CTC grading 821  
 musculoskeletal symptoms, CTC grading 821–2  
 myalgia, CTC grading 831  
 MYC 20  
 myelodysplastic syndromes 562–5  
 myeloma  
   (myelomatosis) 594–600  
   aetiology 594  
   bone resorption 595  
   clinical features 594–6  
   diagnosis 596–600  
   epidemiology 594  
   management 597–600  
   marrow infiltration 594  
   paraproteinaemia 595  
   pathology 594  
   prognosis 600  
   progressive disease 599  
   relapse 599  
   staging 600  
 MYH-associated polyposis 28–9  
 myocarditis, CTC grading 796  
 myositis, CTC grading 821

## N

- nail changes, CTC grading 801  
 naphthylamine exposure 15  
 naproxen 118  
 nasal cavity cancer 472, 477, 488  
 nasal stuffiness, CTC grading 786  
 nasopharyngeal cancer 472, 476–7, 488  
 nausea  
   CTC grading 810  
   morphine-related 119–20  
   and vomiting 126–30, 721

- necrolytic migratory erythema 653  
 nerve blocks 124  
 neural crest tumours, MIBG therapy 77  
 neuroblas-  
   toma 400–1, 674–5  
 neuroconstipation, CTC grading 809  
 neuroendocrine tumours  
   pancreas 364–7  
   small intestine 330–5  
 neurofibromatosis 25, 497  
 neurological paraneoplastic syndromes 650–1  
 neurological symptoms  
   CTC grading 822–7  
   following chemotherapy and radiotherapy 165  
 neuropathic pain 117  
   CTC grading 831  
 neuropathy, CTC grading 825–6  
 neuropsychological consequences of cancer treatment 168  
 neutropenia 686, 687  
   CTC grading 817–18  
 neutrophils  
   BMT specific adverse events 849  
   CTC grading 790  
 night blindness, CTC grading 829  
 nilotinib 559, 560  
 nitroreductase 764  
 NMDA receptor antagonists 124  
 nodal arrhythmias/dysrhythmias, CTC grading 793  
 nodal marginal-zone lymphoma 588  
 nodular  
   lymphocyte-predominant Hodgkin's lymphoma 574  
 non-coding RNAs 774–5  
 non-Hodgkin's lymphomas 582–92  
   aetiology 582  
   AIDS-related 662–3  
   classification 582, 583  
   definition 582  
   high grade 584, 589–92  
   low grade 584, 585–92  
   presentation 584–5  
   staging 584–9  
 non-melanoma skin cancer 542–6  
 non-opioid analgesics 118  
 non-receptor tyrosine kinases 182–3  
 non-small-cell lung cancer  
   adjuvant chemotherapy 236, 241  
   biomarkers 778  
   chemo-irradiation 109, 240, 243  
   chemotherapy 238–41  
   erlotinib therapy 184  
   gefitinib therapy 184  
   investigations 232  
   mediastinal node biopsy 232  
   multidisciplinary teams 232  
   palliative radiotherapy 244  
   PET scanning 232  
   post-operative radiotherapy 244  
   radiotherapy 242–4  
   staging 232, 233  
   surgery 234–6, 240–1  
 non-steroidal anti-inflammatory drugs (NSAIDs) 118  
 novel therapies 749–58  
 nucleus of the tractus solitarius 126  
 nyctalopia, CTC grading 829  
 nystagmus, CTC grading 826
- O**
- obesity 9  
 oblimersen 762  
 obstruction  
   biliary 726–9  
   bowel 38, 128–9, 130, 132  
   intestinal 128–9, 132, 720–3  
   superior vena cava 696–9  
   urinary tract 724–5  
 obstructive  
   jaundice 39, 726–9  
 occupational risks 15, 418  
 ocular symptoms, CTC grading 827–9; see also eye  
 odynophagia, CTC grading 808  
 oedema, CTC grading 795  
 oesophageal cancer 8–9, 109, 318–23  
 oesophageal fistula, CTC grading 808  
 oesophagitis, CTC grading 808  
 oesophagus, RTOG/EORTC late radiation morbidity scoring 844  
 onapristone 174  
 oncogenes 4, 20, 762  
 ondansetron 129–30  
 oocyte storage 163  
 oophoropexy 163  
 opioids 118–22, 124, 125, 143, 154–5  
   oral cavity cancer 472, 476, 488  
   oral hygiene 150–2  
   oral morphine equivalences 122  
   oral mucosa, radiation effects 54  
   oral mucositis 151  
     BMT specific adverse events 849  
     CTC grading 811–12  
   oropharyngeal cancer 8–9, 472, 477, 488  
   osmotic laxatives 137  
   osteolysis 732  
   osteonecrosis, CTC grading 822  
   osteosarcoma 606–10  
   otalgia, CTC grading 830  
   ovarian cancer 215, 446–9  
   ovarian suppression 163  
   ovarian tissue storage 163  
 overflow diarrhoea 136  
 oxaliplatin 96, 165  
 oxycodone 122  
 oxygen therapy 143
- P**
- p53 4, 21, 762, 767  
 P-170 glycoprotein 104  
 packed red blood cells  
   BMT specific adverse events 850  
   CTC grading 791  
 paclitaxel 102  
 Paget's disease of the breast 271, 283  
 pain 116–25  
   adjuvant analgesics 123–5  
   anaesthetic techniques 124  
   categories of cancer pain 116–24  
   CTC grading 829–32  
   non-opioid analgesics 118  
   opioid analgesics 118–22, 124, 125  
   perception of pain 117  
   pharmacological management 117–25  
   radiotherapy for 125  
   supportive care 125



- surgical management 39–40, 124–5  
 WHO analgesic ladder 117  
 palifermin 151  
 palliative care  
 radiotherapy 58, 125  
 surgery 38–40, 124–5  
 symptom control 111–56  
 palpitations, CTC  
 grading 793  
 pamidronate 124  
 pancreatic cancer  
 ductal adenocarcinoma 358–63  
 neuroendocrine tumours 364–7  
 pancreatitis, CTC  
 grading 810  
 pancytopenia 686  
 paracetamol 118  
 paranasal sinuses cancer 472, 477, 488  
 paraneoplastic cerebellar degeneration 650  
 paraneoplastic syndromes 645–54  
 dermatological 653  
 endocrine 648–9  
 haematological 652  
 neurological 650–1  
 paraproteinaemia 594, 595  
 parasitic infections 13  
 parenteral feeding 141  
 Paris system 72–3  
 parotid gland tumour 475  
 partial thromboplastin time, CTC  
 grading 798  
 passenger mutations 22  
 passive smoking 8  
 pelvic pain, CTC  
 grading 831  
 pemetrexed 90  
 pemphigus 653  
 penile cancer 442–3  
 pentostatin 91–2  
 peptide vaccines 766–7  
 percutaneous nephrostomy 724–5  
 performance status 229, 842, 856  
 pericardial effusion 45, 716  
 CTC grading 796  
 pericarditis, CTC  
 grading 796  
 peripheral arterial ischaemia, CTC  
 grading 796  
 peripheral blood progenitors 106  
 peripheral nerve blocks 124  
 peripheral neuropathy 650  
 peripheral primitive neuroectodermal tumour 612  
 perirectal pain, CTC  
 grading 832  
 peritoneal carcinomatosis 637  
 peritoneal metastases 637  
 peritoneal washing cytology 35  
 personality changes, CTC  
 grading 826  
 petechiae, CTC grading 815  
 PET scan 76  
 pheochromocytoma 396–7  
 pharmacological biomarkers 776–7  
 pharmacological exposure 15  
 pharyngeal cancer 472, 476–7, 488  
 pharyngeal fistula, CTC  
 grading 809  
 pharyngeal irritation 128, 132  
 pharyngeal mucositis BMT specific adverse events 849  
 CTC grading 811–12  
 pharyngitis BMT specific adverse events 849  
 CTC grading 811–12  
 phase I/II/III studies 200–1, 210–11, 752  
 phlebitis, CTC grading 796  
 photophobia, CTC  
 grading 829  
 photosensitivity, CTC  
 grading 801  
 physical inactivity 10  
 pigmentation changes 653  
 CTC grading 801  
 pilocarpine hydrochloride 152  
 pineal tumours 506  
 pineocytoma 514  
 pituitary dysfunction 160  
 pituitary tumours 500, 507, 514  
 placental-site trophoblastic tumour 464  
 plasma cell dyscrasias 594  
 plasmacytoma 594, 595–6, 597, 612  
 platelet disorders 652  
 platelets BMT specific adverse events 849, 850  
 CTC grading 790  
 pleomorphic rhabdomyosarcoma 626  
 pleural effusion 44, 640  
 CTC grading 833  
 pleuritic pain, CTC  
 grading 832  
 pneumonitis, CTC  
 grading 834  
 pneumothorax, CTC  
 grading 834  
 POEMS syndrome 596  
 poloxamer 137  
 polymyositis 651  
 popcorn cells 574  
 population screening, see screening  
 porcelain gall bladder 215  
 portal vein flow, CTC  
 grading 816  
 positron emission tomography (PET) 76  
 postnasal drip, CTC  
 grading 786  
 preclinical drug development 751  
 precocious puberty syndrome 397  
 predictive genetic testing 26  
 prednisolone 123–4  
 pregabalin 123–4  
 premature ventricular contractions, CTC  
 grading 794  
 prevention of cancer 203–15  
 process of treatment 168  
 proctalgia, CTC grading 832  
 proctitis, CTC grading 811  
 progestogens 141  
 prolonged QTc interval, CTC  
 grading 793  
 prophylactic surgery 46, 214–15, 266  
 prostate cancer 424–33  
 active surveillance 432–3  
 aetiology 424  
 androgen blockade 428–9, 432  
 brachytherapy 432  
 castration-resistant metastatic disease 429  
 chemotherapy 430  
 epidemiology 424  
 external beam radiotherapy 431–2  
 genetic factors 424  
 Gleason score 424  
 hormone therapy 174, 428–9, 432  
 investigations 426–7  
 medical castration 428  
 metastatic disease 428–33  
 organ-confined disease 430–3  
 pathology 424

- prostate cancer (*Contd.*)  
 presentation 427  
 prognosis 433  
 prostate-specific antigen (PSA) 425–6  
 PSA failure 433  
 radical prostatectomy 431  
 radical radiotherapy 431–2  
 radiotherapy 429–33  
 risk stratification 430–1  
 screening 220–1, 425–6  
 staging 426  
 surgical castration 428  
 proteinuria, CTC  
 grading 835  
 prothrombin time, CTC  
 grading 798  
 proto-oncogenes 4, 762  
 provisional carcinoma of  
 unknown primary 630  
 pruritus 146–7, 653  
 CTC grading 802  
 PSA screening 425–6  
 pseudohyponatraemia 734  
 psychiatric interventions 153  
 psychological distress 153  
 psychological therapies 153  
*PTEN* 20–1  
 pulmonary fibrosis, CTC  
 grading 834  
 pulmonary infiltrates, CTC  
 grading 834  
 pulmonary  
 metastasectomy 259  
 pulmonary symptoms  
 CTC grading 832–4  
 following chemo-  
 therapy and  
 radiotherapy 164–5  
 purine analogues 90  
 purpura, CTC grading 815  
 pyramidal tract dysfunction,  
 CTC grading 826  
 pyrexia of unknown  
 origin 654
- Q**  
 quality of life 202
- R**  
 radiation dermatitis, CTC  
 grading 802  
 radiation-induced pain, CTC  
 grading 831  
 radiation mucositis, CTC  
 grading 810  
 radiation nephropathy 54  
 radiation oncology, see  
 radiotherapy  
 radiation pneumonitis 54  
 radiation recall reaction,  
 CTC grading 802  
 radiation-related cancer 14  
 radiation sensitivity 14  
 radical radiotherapy 58  
 radiculitis, CTC grading 822  
 radioiodine treatment 72,  
 77, 390–1  
 radiolabelled tracers 76  
 radionuclides 72, 76–8,  
 756, 757  
 radiosensitivity  
 syndromes 14  
 radiosensitization 755  
 radiotherapy 49–82  
 accelerated 57  
 acute effects 52–3  
 brachytherapy 70–3, 432  
 cobalt teletherapy 60  
 combined modalities 758  
 combined with chemother-  
 apy (chemo-irradiation)  
 108–9, 755  
 conformal 64, 754  
 CT planning 64, 65  
 DNA repair 55  
 dose units 50  
 effects on normal  
 tissue 52–5, 57  
 electron beam  
 therapy 60, 68–9  
 external beam 60–7, 754  
 four-dimensional 67  
 fractionation 50,  
 56–8, 755  
 $\gamma$ -knife 754  
 historical perspective 50  
 hyperfractionation 57  
 image-guided 66  
 intensity-modulated  
 66–7, 754  
 intraoperative 74, 754  
 late effects 53, 157–68  
 megavoltage 60, 61  
 multileaf collimators 64  
 neuropsychological  
 consequences 168  
 novel approaches 754–8  
 palliative 58, 125  
 radical 58  
 radiosensitivity of  
 tumours 57  
 radiosensitization 755  
 retreatment 55  
 RTOG/EORTC late  
 radiation morbidity  
 scoring 844  
 secondary  
 malignancies 55, 167  
 stereotactic 67, 512  
 superficial 60  
 targeted 77, 754, 756,  
 757, 758  
 tolerance doses 57  
 total body irradiation 80–2  
 unsealed radionuclides 76  
 radium 72  
 raised intracranial pres-  
 sure 128, 132, 700–2  
 raltitrexed 88  
 Ras 4, 20  
 rash  
 BMT specific adverse  
 events 849  
 CTC grading 803, 804  
 raspberry mucilage 151  
 RB1 5  
 receptor tyrosine  
 kinases 182–3  
 rectal bleeding, CTC  
 grading 815  
 rectal cancer  
 adjuvant  
 chemotherapy 304  
 chemo-irradiation 109  
 surgery 302  
 rectal fistula, CTC  
 grading 809  
 rectal pain, CTC  
 grading 832  
 red cell aplasia 652  
 red cell disorders 652  
 red cell transfusion 689  
 red meat 9  
 renal cancer 404–11  
 adjuvant therapy 407  
 aetiology 404  
 biological therapy 408–10  
 chemotherapy 407  
 combined therapy 408–10  
 controversies in  
 treatment 411  
 endocrine therapy 407  
 epidemiology 404  
 genetics 404  
 investigations 405  
 palliative radiotherapy 407  
 pathology 404  
 presentation 406  
 prognosis 410  
 spontaneous  
 remission 407  
 staging 405  
 surgery 406–7  
 renal cell carcinoma  
 biomarkers 779  
 interferon therapy 191  
 interleukin therapy 191–2  
 pathology 404  
 targeted therapy 409–10  
 renal failure,  
 acute 738–9, 740  
 renal pelvis cancer 423

- renal symptoms  
 CTC grading 834–7  
 following chemotherapy  
 and radiotherapy 165
- renal tubular acidosis,  
 CTC grading 836
- reproductive function,  
 CTC grading 837–8
- respiratory acidosis,  
 CTC grading 818
- respiratory alkalosis,  
 CTC grading 819
- respiratory  
 symptoms 142–4
- respiratory tract secretions  
 155
- restlessness, CTC  
 grading 824
- RET 20
- retinoblastoma 5, 492, 674
- retinopathy  
 cancer-associated 651  
 hyperviscosity  
 syndrome 595
- retroperitoneal lymph node  
 metastases 637
- retroviral vectors 771
- Revlimid® (lenalido-  
 mide) 564–5, 598
- rhabdomyosar-  
 coma 626–8, 676
- rigors, CTC grading 799
- Robson staging 405
- RTOG/EORTC late  
 radiation morbidity  
 scoring 844
- RU-486 174
- rubber workers 15
- S**
- saliva replacements/  
 stimulants 152
- salivary gland  
 cancer 472, 475, 477,  
 489  
 CTC grading 811  
 RTOG/EORTC late  
 radiation morbidity  
 scoring 846
- salt fish 9
- sarcoma  
 bone sarcoma reference  
 centres 604  
 chondrosarcoma 616  
 Ewing's 612–15  
 Kaposi's 658–61  
 osteosarcoma 606–10  
 rhabdomyosarcoma  
 626–8, 676  
 soft-tissue 620–4, 676  
 uterine 452
- Schistosomiasis*  
*haematobium* 13
- schwannomas 507–8, 508
- scintigraphic methods 76
- screening 217–21  
 breast cancer 219,  
 266–7, 274–6  
 cervical cancer 220  
 colorectal cancer 220  
 lung cancer 220–1, 226  
 malignant melanoma 528  
 prostate  
 cancer 220–1, 425–6  
 thyroid cancer 383–4
- secondary malignancy  
 chemotherapy-related 167  
 CTC grading 837  
 radiotherapy-related  
 55, 167
- second hits 24
- seizures, CTC grading 826
- selection bias 218
- senna 137
- sensory neuropathy 165  
 CTC grading 826
- sentinel node  
 biopsy 284, 532–3
- sentinel node dissection 42
- serum glutamic oxaloacetic  
 transaminase, CTC  
 grading 816
- serum glutamic pyruvic  
 transaminase, CTC  
 grading 816
- serum sickness, CTC  
 grading 787
- sexual function, CTC  
 grading 837–8
- shortness of breath 142–3  
 CTC grading 833
- single-nucleotide  
 polymorphisms 30
- single-photon emission com-  
 puterized tomography  
 (SPECT) 76
- singultus, CTC grading 833
- sinus bradycardia,  
 CTC grading 793
- sinus tachycardia,  
 CTC grading 793
- skin  
 cancers 14, 523–47  
 CTC grading 800–4  
 paraneoplastic  
 syndromes 653  
 radiation effects 53–4  
 RTOG/EORTC late  
 radiation morbidity  
 scoring 846
- skull base tumours 500
- small-cell lung cancer 245  
 chemotherapy 246–7
- palliative radiotherapy 249  
 prognosis 245  
 prophylactic cranial  
 irradiation 249  
 radiotherapy 248–9  
 staging 245  
 surgery 250
- small intestine  
 RTOG/EORTC late  
 radiation morbidity  
 scoring 846  
 tumours 330–5
- small-molecule  
 inhibitors 182–6
- smell disturbances,  
 CTC grading 811
- smoking 8, 206, 470
- smooth muscle  
 relaxants 124
- sneezing, CTC grading 786
- sodium picosulfate 137
- sodium valproate 123–4
- soft-tissue  
 sarcomas 620–4, 676  
 solar exposure 14, 526–7  
 solitary extramedullary  
 plasmacytoma 597  
 solitary plasmacytoma 594,  
 595–6, 597, 612
- somatic correction of gene  
 defects 762
- somatic pain 116–17
- somatostatinoma 366
- sorafenib 185
- SPECT 76
- speech  
 CTC grading 826  
 post-laryngectomy 490
- sperm retrieval 162–3
- spinal cord  
 compression 682–4  
 RTOG/EORTC late  
 radiation morbidity  
 scoring 847  
 tumours 497, 499,  
 500, 508
- spinal irradiation,  
 side-effects 512
- spinal opioids 124
- spindle poisons 100, 101
- splenic marginal zone  
 lymphoma 588
- squamous cell carcinoma  
 anal 314–15  
 head and neck 474  
 skin 542, 543, 544, 546  
 squashed stomach 128–9
- SRC 20
- stem cell transplantation  
 555, 560, 564, 571, 587
- stereotactic  
 radiotherapy 67, 512

- sterility, CTC grading 837  
steroid hormone  
  antagonists 173–4  
steroids 123–4  
Stevens–Johnson syndrome,  
  CTC grading 801  
Stewart classification 319  
stimulant laxatives 137  
stomach, squashed 128–9  
stomatitis  
  BMT specific adverse  
  events 849  
  CTC grading 811–12  
stool softeners 137  
stridor 705  
  CTC grading 834  
stromal sarcomas 452  
strong opioids 118–22  
subcutaneous tissue,  
  RTOG/EORTC late  
  radiation morbidity  
  scoring 847  
sun exposure 14, 526–7  
sunitinib 182, 185  
superficial X-ray therapy 60  
superior vena cava  
  obstruction 696–9  
support 153  
support agencies 857–8  
supportive care 125  
supraventricular tachycardia,  
  CTC grading 793  
surgery 31–46  
  curative 36–7  
  diagnosis and staging 34–5  
  metastatic disease 42–5  
  palliative 38–40, 124–5  
  principles 33  
  prophylactic 46,  
  214–15, 266  
surgical neuronavigation 516  
sweating, CTC grading 799  
symptom control 111–56  
syncope, CTC grading 827  
syndrome of inappropriate  
  ADH 648, 734  
  CTC grading 805  
synthetic lethality 23  
syphilis 470
- T**
- tamoxifen 173–4, 210–11,  
  267, 288  
Tarceva® (erlotinib) 182, 184  
targeted chemotherapy 84  
targeted radiotherapy 77,  
  754, 756, 757, 758  
targeted therapy 179–95  
taste disturbances 152  
  CTC grading 812  
tearing, CTC grading 828
- tegafur with uracil 89  
temosirolimus 185–6  
temozolomide 85  
teniposide 99  
terminal phase 154–5  
testes, undescended 215  
testicular cancer 434–41  
  aetiology 434  
  carcinoma *in situ* 438  
  epidemiology 434  
  follow-up 441  
  genetics 434  
  investigations 436  
  management 438–41  
  non-germ cell  
  tumours 441  
  non-seminomatous  
  germ cell  
  tumours 434, 439–41  
  pathology 434–5  
  presentation 435–6  
  prognostic  
  grouping 436, 441  
  seminomas 434,  
  438, 439–41  
  sperm storage 436  
  staging 436  
  tumour markers 435, 774  
textile workers 15  
thalidomide 597  
therapeutic drug  
  monitoring 776  
6-thioguanine 90  
thiopurine  
  methyltransferase 776  
thoracic  
  malignancies 225–59  
thrombocytopenia 652, 688  
  heparin-induced 713  
thrombocytosis 652  
thromboembolic  
  disease 712–14  
thrombosis  
  central venous lines 745  
  CTC grading 797  
thrombotic microangiopathy  
  BMT specific adverse  
  events 850  
  CTC grading 798  
thrombotic thrombocy-  
  topenic purpura, CTC  
  grading 798  
thymic tumours 256–8  
thymidylate synthase  
  inhibitors 88  
thymomas 256–8  
thyroid cancer 382–95  
  aetiology 382  
  anaplastic (undifferenti-  
  ated) 382, 383, 384,  
  386, 389, 392, 395  
  chemotherapy 394  
  differentiated (papillary  
  including follicular)  
  382–3, 384, 385,  
  387–8, 392, 395  
  epidemiology 382  
  external beam  
  radiotherapy 392  
  follow-up 395  
  genetics 382–4  
  investigations 385  
  medullary 382, 383–4,  
  386, 389, 392, 395  
  MEN type 2 214–15, 383  
  metastatic disease 388  
  pathology 382–4  
  presentation 384  
  prognosis 395  
  radioiodine  
  treatment 77, 390–1  
  recurrent 388  
  screening and preven-  
  tion 214–15, 383–4  
  small molecule kinase  
  inhibitors 393  
  staging 385–6  
  surgery 387–9  
  surveillance 395  
  targeted therapies 393  
thyroid dysfunction  
  following radiotherapy  
  and chemotherapy 160  
thyroid scintigraphy 77  
tobacco 8, 206, 470  
Tomudex® 88  
topoisomerase  
  inhibitors 98–9  
topotecan 98  
total body irradiation 80–2  
total white cell count  
  BMT specific adverse  
  events 848  
  CTC grading 789  
toxic epidermal necrolysis,  
  CTC grading 801  
TP53 20–1  
tramadol 118  
transfusion  
  BMT specific adverse  
  events 850  
  CTC grading 791  
transitional cell carcinoma  
  renal 404, 410  
  ureteric 423  
trastuzumab  
  (Herceptin®) 164,  
  188, 294  
tremor, CTC grading 827  
tricyclic  
  antidepressants 123–4  
trophoblastic  
  tumours 460–4  
tuberous sclerosis 497

tubulin-interactive agents 100, 101  
 tumour-blocking agents 212  
 tumour flare, CTC grading 839  
 tumour-infiltrating lymphocytes 194  
 tumour lysis syndrome 740–2  
 CTC grading 839  
 tumour necrosis factor 192  
 tumour pain, CTC grading 832  
 tumour seeding 34–5  
 tumour spread 33  
 tumour-suppressing agents 212, 213  
 tumour suppressor genes 4, 20–1, 762  
 Turcot's syndrome 497  
 typhlitis, CTC grading 812  
 tyrosine kinase inhibitors 182–4  
 Tyverb® (lapatinib) 182, 184–5, 294

**U**

Uftoral® 89  
 ulcerative colitis 214–15  
 uncertainty 114  
 undescended testes 215  
 unsealed radionuclides 76  
 upper gastrointestinal cancer 317–80  
 ureter  
 decompression 724–5  
 obstruction, CTC grading 836  
 operative injury, CTC grading 835  
 transitional cell carcinoma 423  
 urgency, CTC grading 836  
 uridine diphosphate glucuronyltransferase 776  
 urinary electrolyte wasting, CTC grading 836  
 urinary frequency/urgency, CTC grading 836  
 urinary retention, CTC grading 836  
 urinary tract obstruction 724–5

urine colour changes, CTC grading 836  
 urokinase 713  
 urticaria, CTC grading 787, 804  
 uterine corpus cancer 450–3

**V**

vaccines 195, 761, 766–8  
 vaginal bleeding, CTC grading 815  
 vaginal cancer 458  
 vaginal dryness, CTC grading 838  
 vaginal fistula, CTC grading 835  
 vaginitis, CTC grading 837  
 vasculitis, CTC grading 787  
 vasovagal episode, CTC grading 793  
 vectors 770, 771  
 vegetable consumption 9, 208  
 VEGF pathway inhibitors 185  
 vein, operative injury, CTC grading 796  
 vemurafenib 186  
 vena cava filter 713  
 venous thromboembolism 712–13  
 ventilation–perfusion mismatch 142  
 venting gastrostomy 130  
 ventricular arrhythmia, CTC grading 794  
 Verner–Morrison syndrome 365–6  
 vertigo, CTC grading 827  
 vesicovaginal fistula, CTC grading 835  
 vestibular schwannoma 507–8  
 vinblastine 101  
 vincristine 101  
 vindesine 101  
 vinorelbine 101  
 VIPoma 365–6  
 virally-induced tumours 12–13, 195, 470  
 viral mouth infections 151  
 viral vectors 770, 771

virilization syndrome 397  
 virus-directed enzyme pro-drug therapy 764, 765  
 visceral arterial ischaemia, CTC grading 797  
 visceral pain 116–17  
 visual symptoms, CTC grading 827–9  
 vitiligo 653  
 CTC grading 801  
 voice, CTC grading 834  
 vomiting, CTC grading 812; see also nausea and vomiting  
 vomiting centre 126, 128  
 von Hippel–Lindau syndrome 404, 497  
 vulval cancer 459

## W

WAGR syndrome 412  
 warfarin 712, 713, 745  
 watery diarrhoea and hypokalaemia achlorhydria (WDHA) syndrome 365–6  
 watery eyes, CTC grading 828  
 weak opioids 118  
 weight changes  
 BMT specific adverse events 850  
 CTC grading 800  
 welts, CTC grading 804  
 wheals, CTC grading 804  
 white cell count  
 BMT specific adverse events 848  
 CTC grading 789  
 white cell disorders 652  
 WHO analgesic ladder 117  
 whole tumour cell preparations 766  
 Wilms' tumour 412–16  
 in adults 675  
 wood dust 471  
 wounds, CTC grading 804

## Z

zoledronic acid 124  
 Zubrod scale 229, 842

